



2023 PRIMARY 6 Common-Timed Practice

Name: _____ ()

Date: 11 May 2023

Class: Primary 6 ()

Time: 0830-1015

Duration: 1 hour 45 minutes

Parent's Signature: _____

Marks: _____ / 56

SCIENCE BOOKLET A

INSTRUCTIONS TO CANDIDATES

1. Write your name, class, and register number.
2. Do not turn over this page until you are told to do so.
3. Follow all instructions carefully.
4. Answer all questions.
5. Shade your answers on the Optical Answer Sheet (OAS) provided.

Booklet A (28 x 2 marks)

For each question from 1 to 28, four options are given. One of them is the correct answer. Make your choice (1, 2, 3 or 4) and shade your answer on the Optical Answer Sheet.

(56 marks)

1. Four pupils saw an organism at the zoo as shown below. They identified it as a mammal.

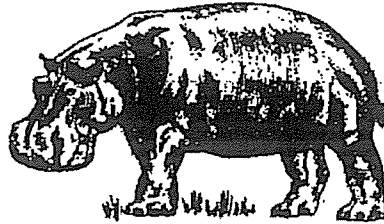

All four pupils made statements about the organism they saw.

- Alice: It has four legs.
Samy: It has hair on its body.
Ramu: It breathes through its lungs.
Mei Mei: It produces milk for its young.

Whose statements could conclude that the organism was a mammal?

- (1) Alice only
- (2) Samy and Ramu only
- (3) Samy and Mei Mei only
- (4) Alice, Ramu and Mei Mei only

2. The diagram below shows a plant cell.

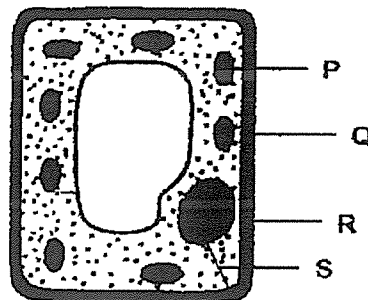

Which two parts can be found in animal cells?

- (1) P and Q
- (2) P and R
- (3) Q and S
- (4) R and S

3. Plant Q grows by wrapping itself tightly around other plants.

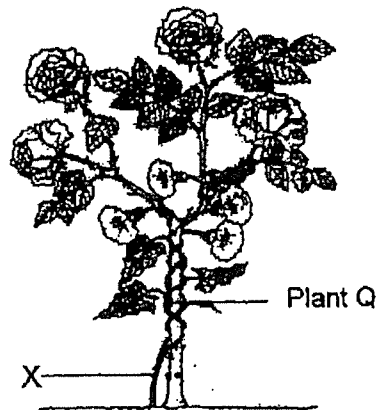

A gardener cut the stem of Plant Q at X. After some time, the part of Plant Q above X was dead.

What is the most likely reason for the part of Plant Q above X to die?

- (1) There was a lack of food.
- (2) There was a lack of sunlight.
- (3) The part above X did not receive water.
- (4) The part above X did not receive carbon dioxide.

4. The diagram below shows the exchange of gases amongst organisms P, Q and R, and their surroundings during the day.

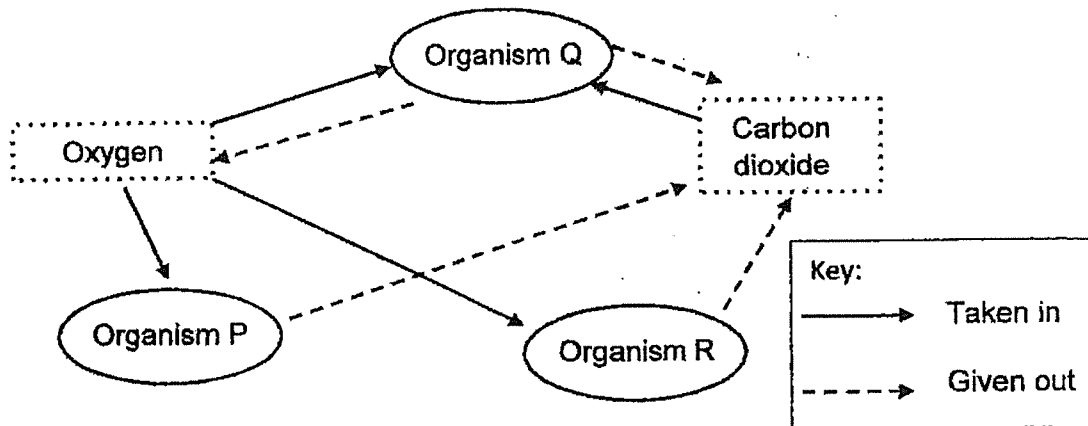

Based on the diagram, which living things do organisms P, Q and R represent?

	P	Q	R
(1)	fern	grass	fungi
(2)	fungi	bacteria	fern
(3)	mould	fern	bacteria
(4)	bacteria	grass	fern

5. The diagram below represents the human circulatory system. The arrows represent blood vessels carrying blood to and from the head, lungs, heart and legs.

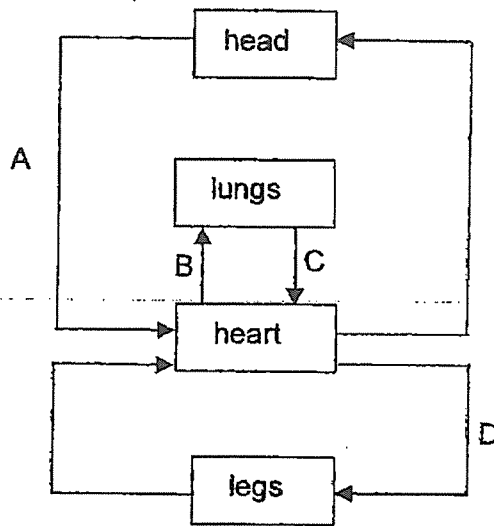

Which one of the following correctly shows the amount of carbon dioxide in the blood carried by the blood vessels A, B, C and D?

	Blood poor in carbon dioxide	Blood rich in carbon dioxide
(1)	A and B	C and D
(2)	B and C	A and D
(3)	B and D	A and C
(4)	C and D	A and B

6. The diagram below shows a food web in a community.

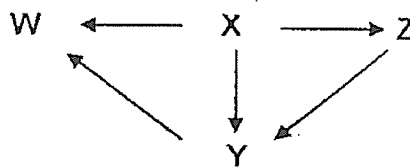

Which one of the following correctly identifies organisms W, X, Y and Z?

	Producer	Prey	Prey and predator	Predator
(1)	X	Z	Y	W
(2)	X	Y	Z	W
(3)	W	X	Y	Z
(4)	W	Y	Z	X

7. Wendy counted the number of organisms in a habitat. She recorded her observations in the table below.

Type of organism	Number of organisms
Butterfly	2
Fish	2
Frog	2
Caterpillar	4
Tadpole	5
Water lily	3
Hydrilla	4
Water hyacinth	2

Based on Wendy's table, which of the following statements is correct?

- (1) There are 7 water plants.
 - (2) There are 8 communities.
 - (3) There are 5 populations of animals.
 - (4) There are 6 populations of plants and animals in total.
8. The graph below shows how organisms P, Q and R in a habitat are affected when organism F is introduced at point E.

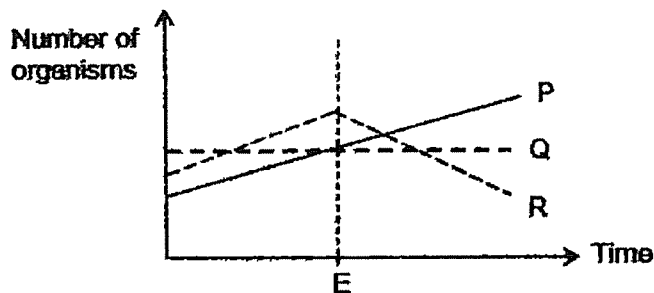

Based on the information above, which of the following statement(s) is/are true?

- A R is eaten by F.
 - B F is a food producer.
 - C P and Q compete for food.
- (1) A only
 - (2) A and B only
 - (3) B and C only
 - (4) A, B and C

9. The graph below shows the amount of food that was digested in different parts of the human digestive system.

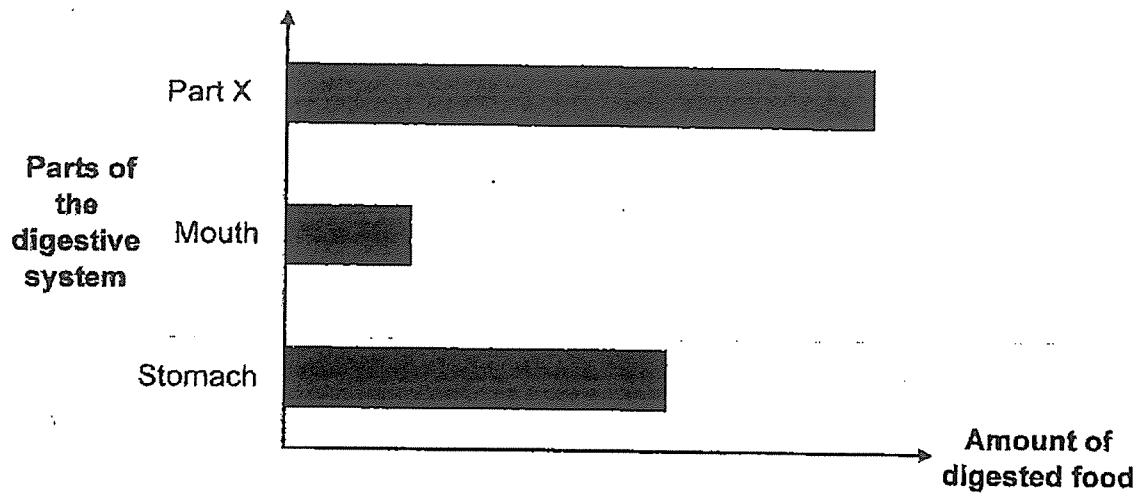

Which part of the digestive system is represented by Part X?

- (1) Anus
- (2) Gullet
- (3) Small Intestine
- (4) Large Intestine

10. The diagrams below show the life cycles of two insects.

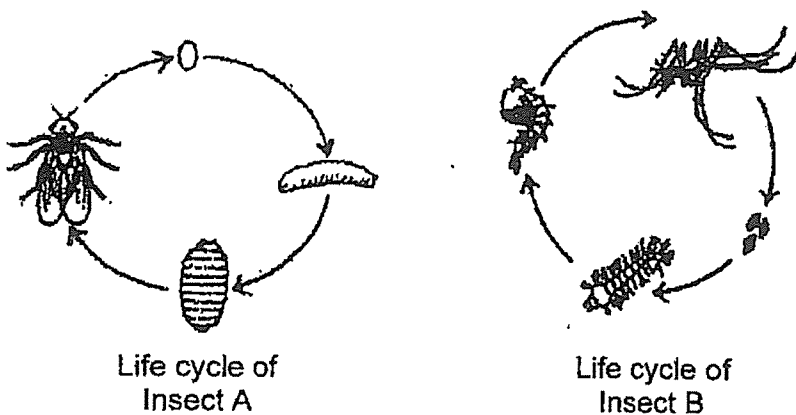

Based on what you can observe from the life cycles above, which of the following best describes a similarity of the young of both insects?

- (1) They look like their parents.
- (2) They go through the pupal stage.
- (3) They have more legs than their parents.
- (4) They live in the same habitat as their parents.

11. Olivia cut a brightly-coloured fruit in half and observed that it contained many seeds as shown in the diagram below.

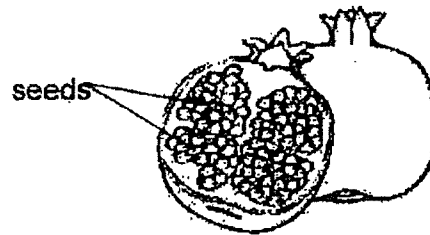

Based only on her observation, which one of the following statements is definitely true about the flower that this fruit has developed from?

- (1) The flower has many ovules.
 - (2) The flower has many ovaries.
 - (3) The flower produced many pollen grains.
 - (4) The flower has been pollinated by animals.
12. Which of the following is/are behavioural adaptation(s) that will help an animal to escape from its predators?
- A Having soft pads on paws
 - B Moving quickly and without making any sound
 - C Decorating the nest with colourful pebbles and flowers
 - D Having body covering that has similar colours as its surroundings
- (1) B only
 - (2) B and C only
 - (3) A and D only
 - (4) A, C and D only

13. Daphne wanted to find out if the presence of chemical J in water would affect the growth of organism V. She used the set-up below for her experiment.

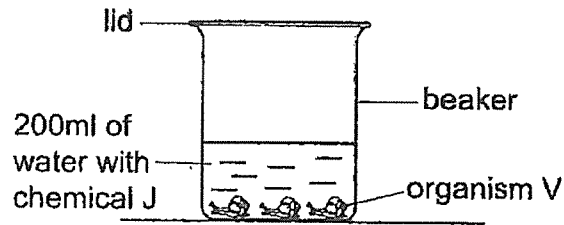

Which one of the following set-ups should she use as a control for her experiment?

(1)

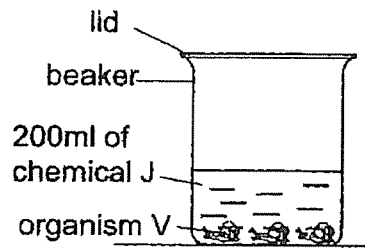

(2)

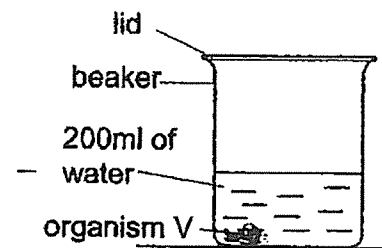

(3)

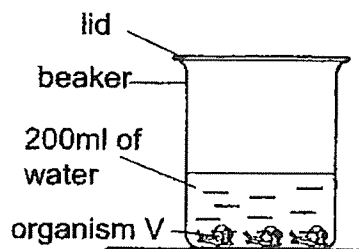

(4)

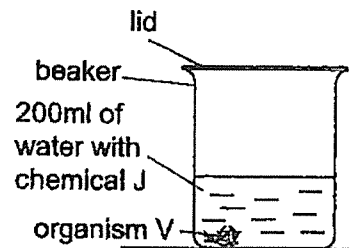

14. Ameer collected four different soil samples M, N, P and Q. He poured the same amount of soil sample into a funnel with its end plugged with some cotton wool. Then he poured 200 ml of water onto each soil sample as shown below.

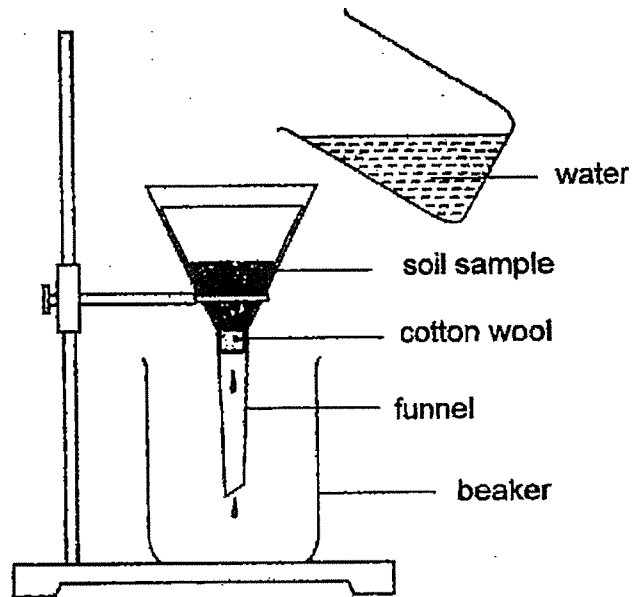

He measured and recorded the amount of water collected in the beaker 15 minutes after the first drop of water flowed out from the funnel into the beaker.

He recorded his results in the table below.

Soil Sample	Amount of water collected after 15 minutes (ml)
M	110
N	60
P	150
Q	90

Which soil would most likely be found in the desert?

- (1) Soil M
- (2) Soil N
- (3) Soil P
- (4) Soil Q

15. Sean conducted several tests on materials A, B, C and D. He recorded his results in the table below. A tick (✓) indicates the presence of the property and a cross (X) indicates the absence of the property.

Property	Materials			
	A	B	C	D
Flexible	X	✓	X	✓
Break easily when dropped	✓	X	X	X
Waterproof	✓	✓	✓	X

Which material, A, B, C or D, is most suitable to make the tyre of a car?

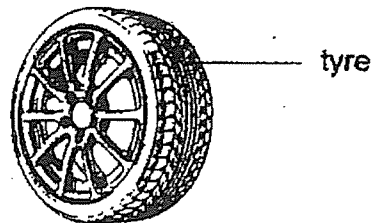

- (1) A
- (2) B
- (3) C
- (4) D

16. Ali set up the following experiment in a dark room. A light sensor was attached onto the screen and gave a reading of 50 units.

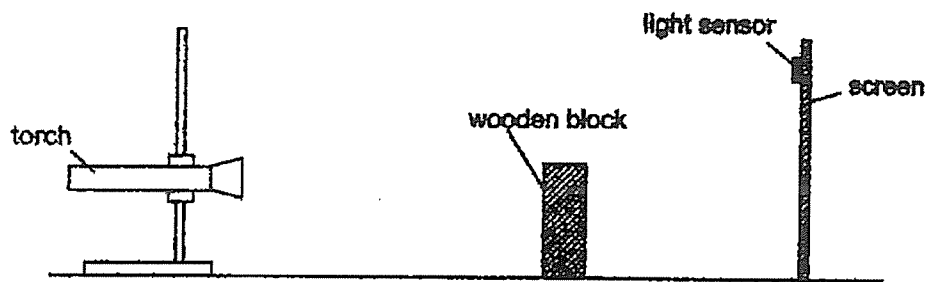

What should Ali do to get the smallest possible shadow, and what will be the possible reading on the light sensor?

	Action	Light sensor reading (unit)
(1)	Move the torch nearer to the wooden block	70
(2)	Move the screen nearer to the wooden block	30
(3)	Move the torch away from the wooden block	30
(4)	Move the screen away from the wooden block	70

17. Sharon was able to arrange four bar magnets as shown below.

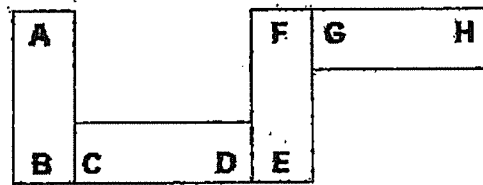

Which of the following is another possible arrangement for the above magnets?

(1)

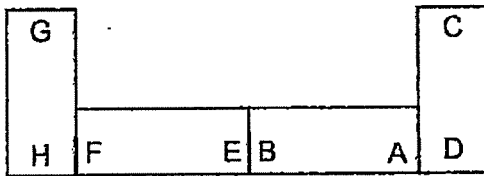

(2)

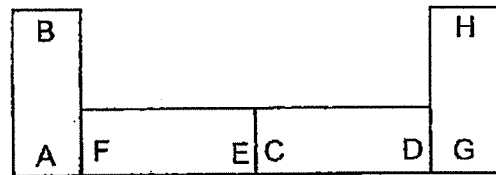

(3)

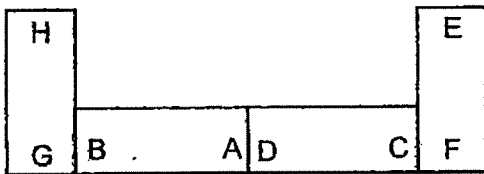

(4)

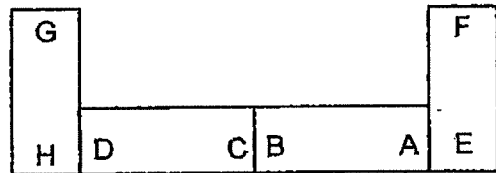

18. Ahmad has four identical containers filled with different amounts of water. The water in each beaker is 50°C . He heated four identical metal balls to 90°C and dropped a ball into each of the beakers at the same time.

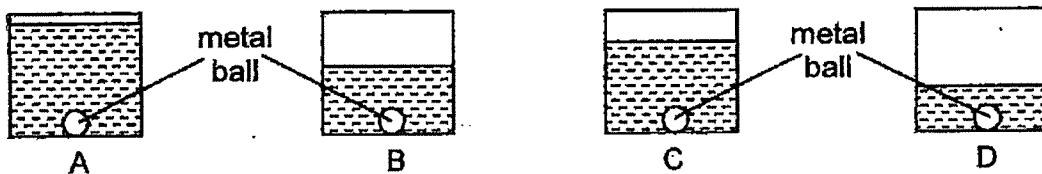

Which beaker of water will have the lowest temperature at the end of one minute?

- (1) A
- (2) B
- (3) C
- (4) D

19. At 30°C, substance Z has a definite volume and does not take the shape of the container. However, at 200°C, substance Z can be compressed.

Which one of the following is most likely the melting point and boiling point of substance Z?

	Melting point of Z	Boiling point of Z
(1)	15	200
(2)	25	120
(3)	35	180
(4)	45	300

20. The diagram below shows the side view of a roller coaster ride.

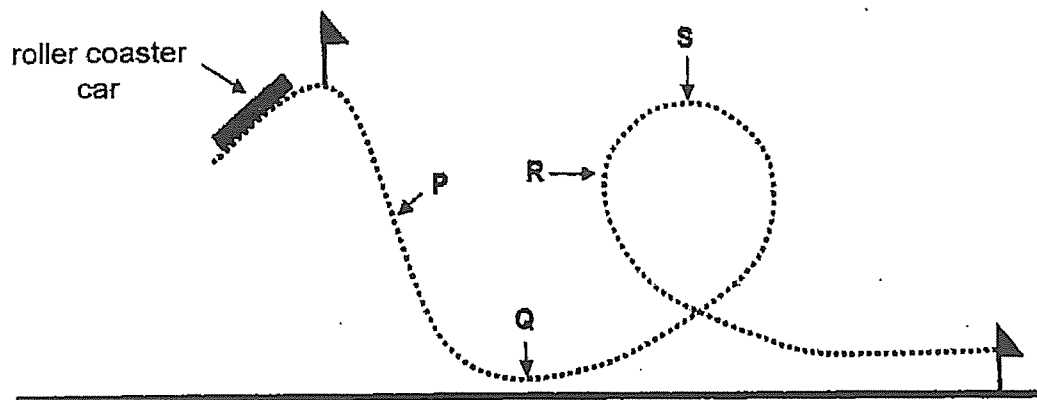

At which point along the ride would the roller coaster car have the most kinetic energy?

- (1) P
- (2) Q
- (3) R
- (4) S

21. Ken had two similar thermometers and a glove on a table. All these items were at room temperature at the beginning. He then placed one thermometer inside the glove and the other one on the table. The room temperature stayed constant.

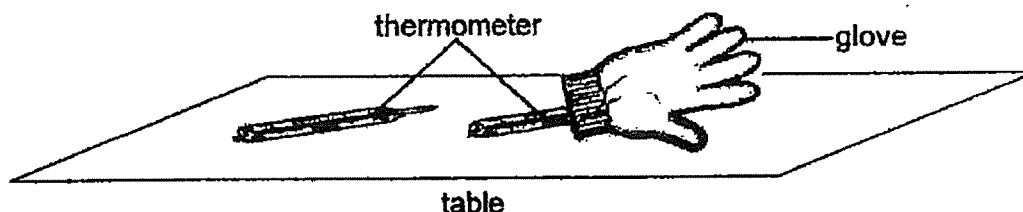

What would he observe about the readings of the thermometers after some time?

- (1) The readings of both thermometers would be higher than room temperature.
 - (2) The readings of both thermometers would be the same as the room temperature.
 - (3) The reading of the thermometer in the glove would be lower than the one outside.
 - (4) The reading of the thermometer in the glove would be higher than the one outside.
22. A potted plant was dropped from point P to point Q as shown in the diagram below.

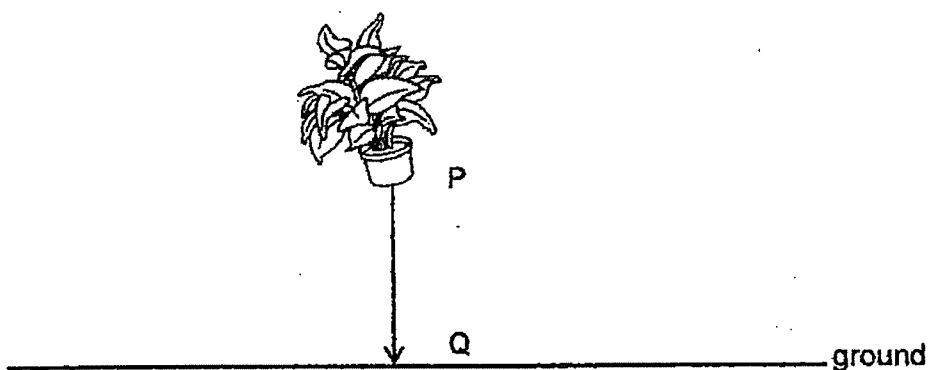

Which of the following is correct?

	Potential energy of the potted plant from P to Q	Kinetic energy of the potted plant from P to Q
(1)	decreases	increases
(2)	decreases	decreases
(3)	increases	remains the same
(4)	remains the same	decreases

23. Sandra set up the following experiment. When she released the ball, it travelled down the ramp and stopped at point C.

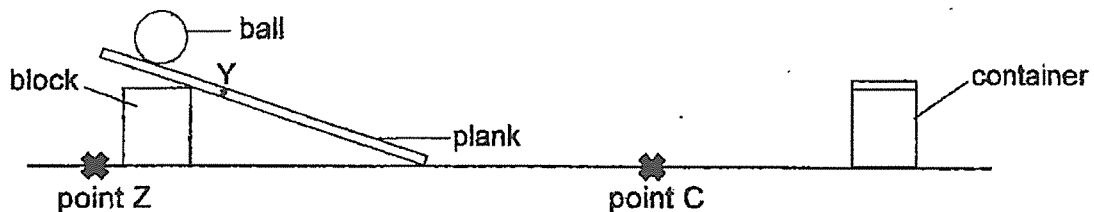

Without changing any of the apparatus, which of the following would most likely allow the ball to travel further in order to hit the container?

- (1) Apply oil on the ball.
 - (2) Move the block to point Z.
 - (3) Release the ball from point Y.
 - (4) Wrap the plank with sandpaper.
24. Study the diagram below. When the plunger is pushed all the way in, all the air from the pump goes into the metal container.

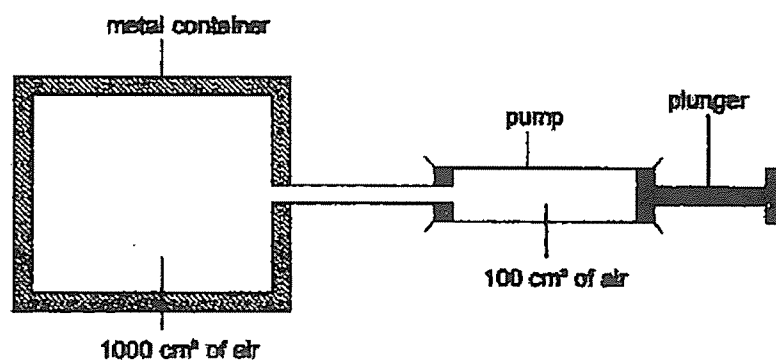

Which one of the following shows what happens to the volume and mass of air in the metal container when the plunger is pushed all the way in?

	Volume of air in the metal container	Mass of air in the metal container
(1)	increases	Increases
(2)	remains the same	remains the same
(3)	remains the same	increases
(4)	Increases	decreases

25. Soo Ling conducted an experiment to investigate the effect of a force applied on four different springs, A, B, C and D. She measured the length of the spring before and after a 400g load is attached to the end of each spring. The results are shown in the graph below.

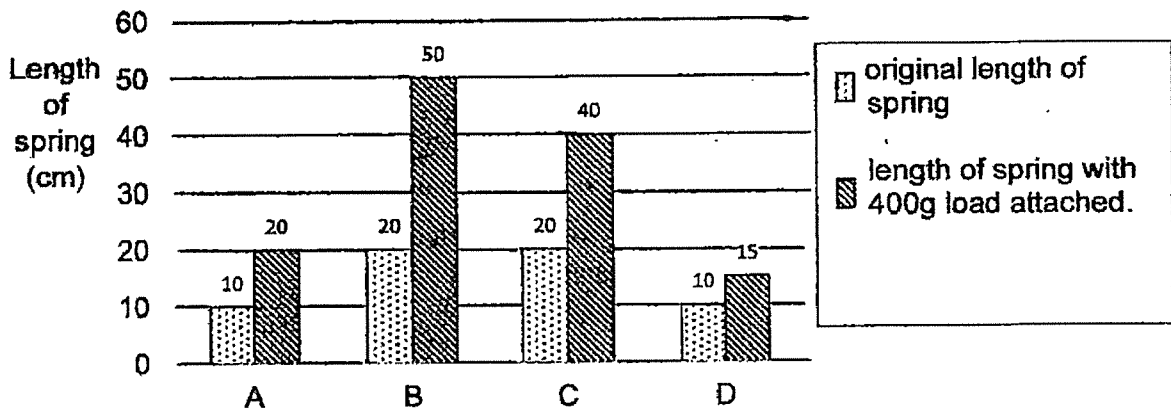

Which one of the springs, A, B, C or D is the stiffest?

- (1) A
 (2) B
 (3) C
 (4) D
26. Nelson taped a balloon firmly to a toy car to create a 'balloon racer' as shown in the diagram below.

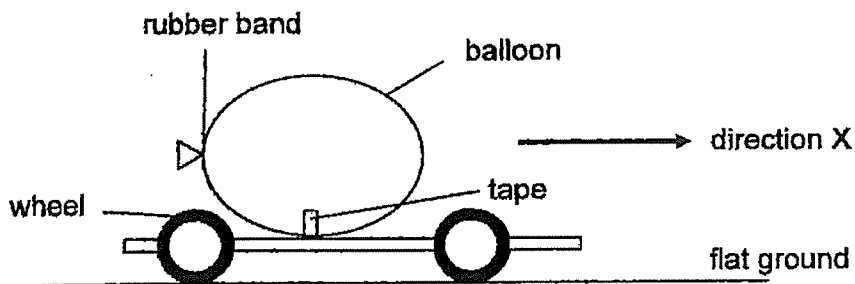

When the rubber band was removed, air rushed out of the balloon, producing a force.

This force caused the balloon and the toy car to move in direction X because this force was greater than the _____.

- (1) weight of the toy car and the balloon
 (2) weight of the balloon and the wheels
 (3) friction between the wheels and the ground
 (4) friction between the balloon and the toy car

27. Jun Xiong measured the mass of a magnet on an electronic balance. He recorded his results in the table below.

Magnet	Mass (units)
A	95
B	100

He then set up the experiment shown below. He placed Magnet A on a spring balance with its north-pole facing Magnet B's north-pole and observed the readings on the spring balance and electronic balance respectively.

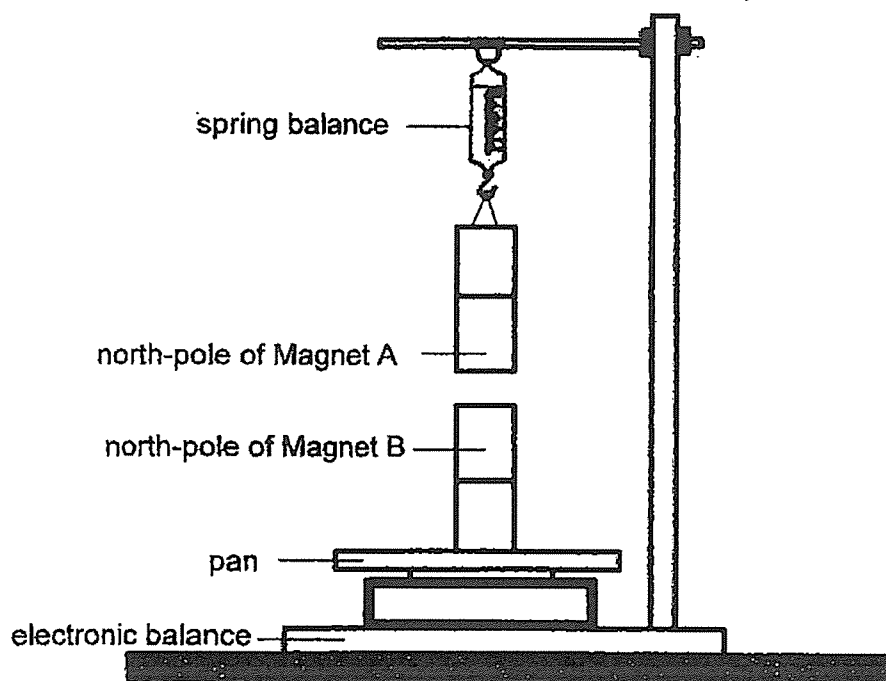

Which of the following could possibly be the readings on the spring balance and electronic balance?

	Readings on spring balance	Readings on electronic balance
(1)	Less than 95 units	More than 100 units
(2)	More than 95 units	More than 100 units
(3)	More than 95 units	Less than 100 units
(4)	Remained at 95 units	Remained at 100 units

28. Vishnu set up four electrical circuits using identical batteries and identical bulbs. The batteries and bulbs are working properly.

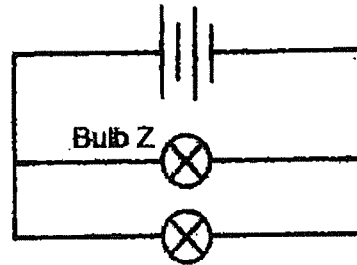
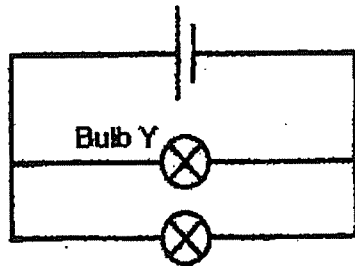
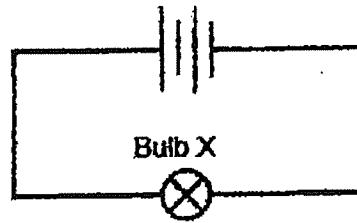
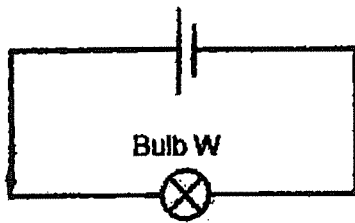

Which of the following statement(s) is/are correct?

- A Bulb W is the brightest.
- B Bulb Z is dimmer than Bulb W.
- C Bulb Z is brighter than Bulb Y.
- D Bulb X and Bulb Z have the same brightness.

- (1) C only
- (2) C and D only
- (3) A, B and D only
- (4) B, C and D only



2023 PRIMARY 6 Common-Timed Practice

Name : _____ ()

Date: 11 May 2023

Class : Primary 6 ()

Time: 0830 – 1015

Parent's Signature : _____

Duration: 1 hour 45 minutes

SCIENCE

BOOKLET B

INSTRUCTIONS TO CANDIDATES

1. Write your name, class and register number.
2. Do not turn over this page until you are told to do so.
3. Follow all instructions carefully.
4. Answer all questions.
5. Use a dark blue or black ballpoint pen to write your answers in the booklet in the space provided for each question
6. Do not use correction fluid/tape or highlighters.

Booklet A	56
Booklet B	44
Total	100

For questions 29 to 40, write your answers clearly in this booklet. The number of marks available is shown in brackets [] at the end of each question or part question. (44 marks)

29. The diagram below shows a human arm.

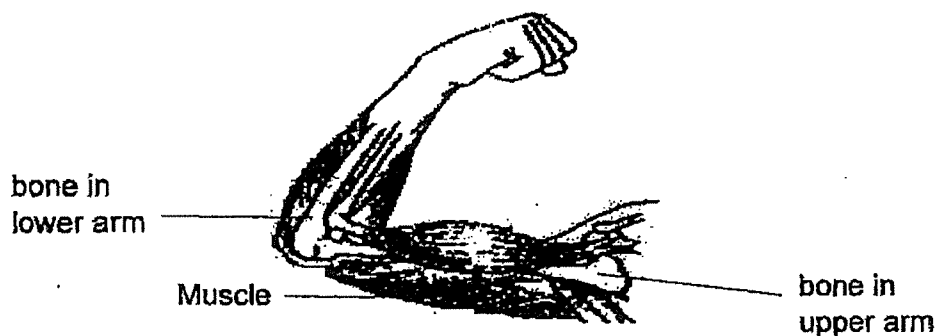

(a) Based on the diagram above, which two systems are needed to work together to straighten the arm? [1]

(i) System 1: _____

(ii) System 2: _____

(b) State two substances the circulatory system delivers to the arm to release energy for the arm to move. [1]

(c) Name all the parts that make up the circulatory system. [1]

Score	3
-------	---

30. Melissa wanted to find out which part of a river has the most decomposers. She collected equal volumes of water samples from different locations, A, B and C, along a river. She measured the amount of dissolved oxygen and carbon dioxide in each water sample and showed the results in the following graph.

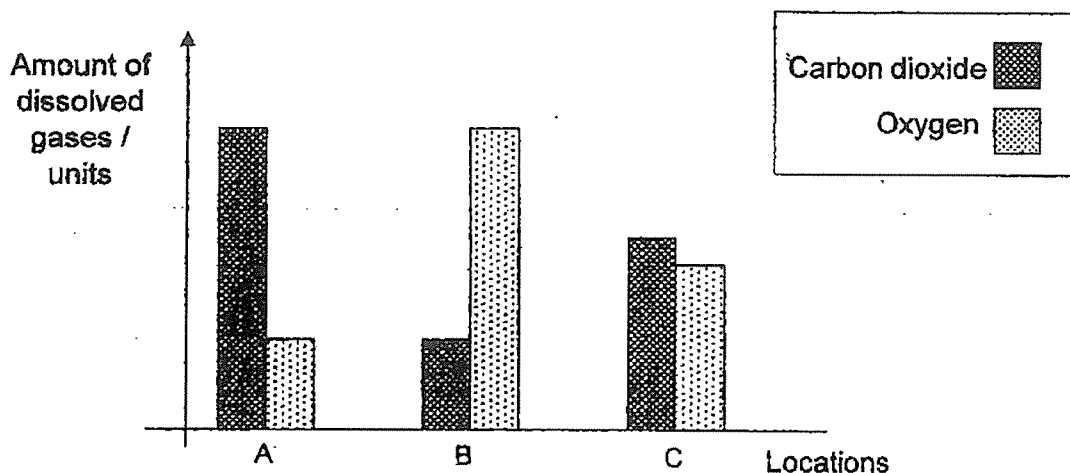

- (a) Arrange the water samples from locations, A, B and C, in increasing number of decomposers in the boxes below. [1]

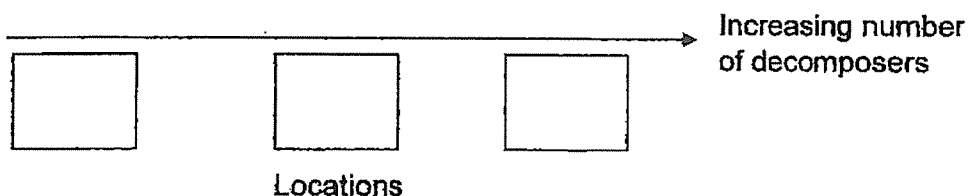

- (b) What kind of environmental condition would speed up the rate of decomposition of dead matter in the river? [1]

- (c) Melissa wanted to introduce a large number of floating water plants into the river to increase the amount of dissolved oxygen in the water. Explain why this suggestion may not work. [1]

Score	3
-------	---

31. The diagram below shows two fruits, Q and R:

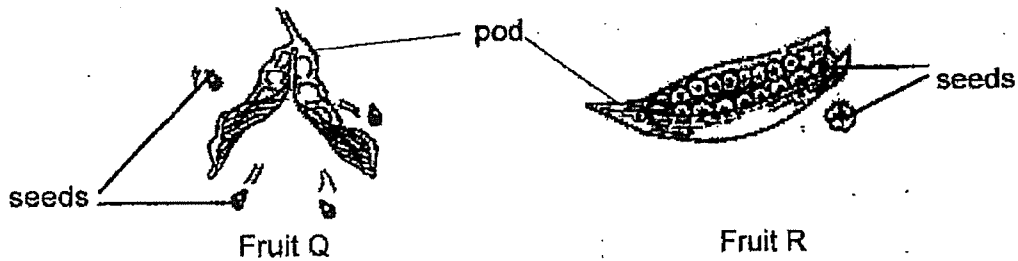

Bala made some observations about the seeds from both fruits and recorded them in the table shown.

Seeds from fruit Q	Seeds from fruit R
small and hard	light with transparent wings

(a) Based on the information above, explain how fruit R dispersed its seeds. [2]

(b)(i) After the seeds from fruits Q and R had been dispersed, the positions of their seedlings are indicated in the diagram below.

Place a tick (✓) in one box to identify the correct position of the parent plant of fruit Q. [1]

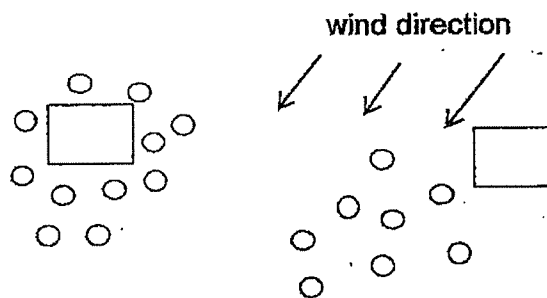

(ii) Explain your choice in (b)(i). [1]

4

Score	4
-------	---

32. Study the food web below.

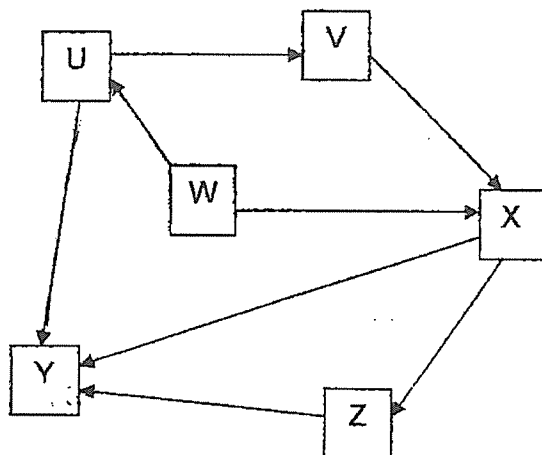

(a) How many food chains are there in the food web above? [1]

(b) Classify all the organisms in the food web by writing the correct letter, U, V, W, X, Y and Z, in the boxes of the chart below. You may write more than one letter for each box. [2]

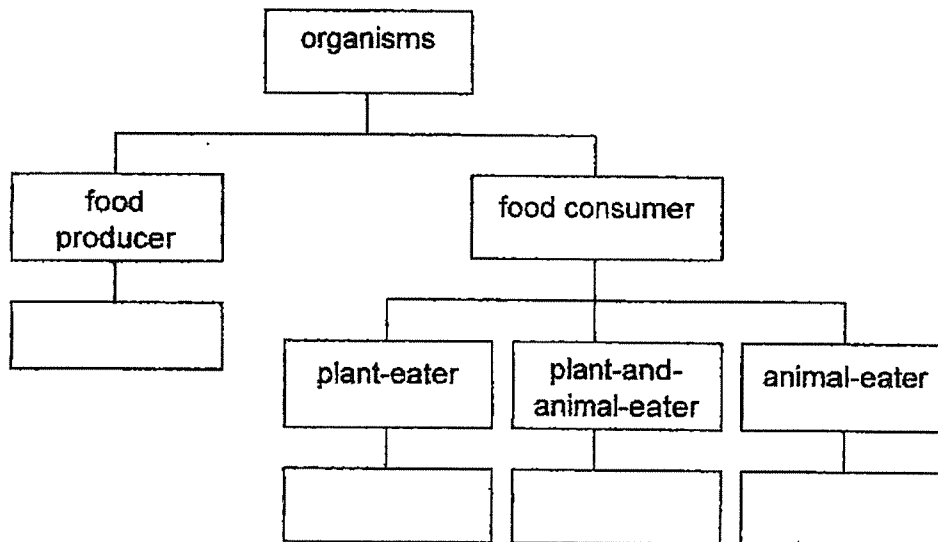

(c) If a disease has wiped out organisms U, X and Z in the community, what can organism Y do to survive? [1]

Score	4
-------	---

33. Animal S releases a sweet substance which will attract animal R. Animal R feeds on this sweet substance. Animal R fights off attacks from other insects that feed on animal S.



(a) How do animal R and S benefit from this relationship?

(i) Benefit for animal R: [1]

(ii) Benefit for animal S: [1]

(b) The graph below shows how the population of animal R changes over a period of time.

Using the legend provided in the box, draw on the same graph to show how the population of animal S changes over time. [1]

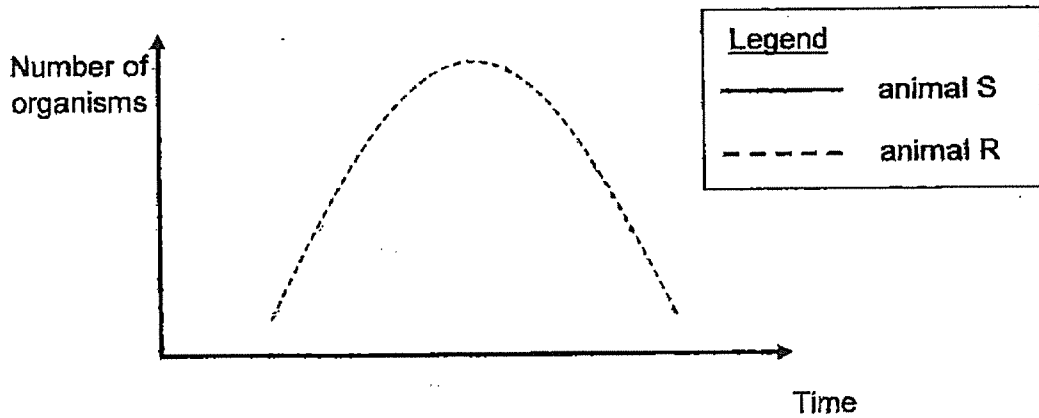

(c) Based only on the information provided, explain how the population of animal S would be affected if a disease struck and killed most of the animal R. [1]

Score	4
--------------	---

34. Ann bought some hot buns from a stall. The hot buns were placed in a box as shown below.

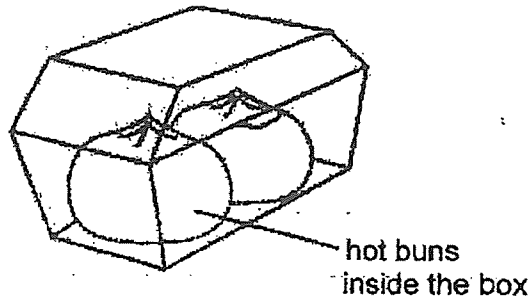

When she opened the box, she observed that the buns were wet.

- (a) Explain why the hot buns in the box became wet. [2]

At the next visit to the same stall, she bought two boxes of hot buns, A and B. Then, she asked the stallholders to poke holes on the boxes as shown in the diagram below.

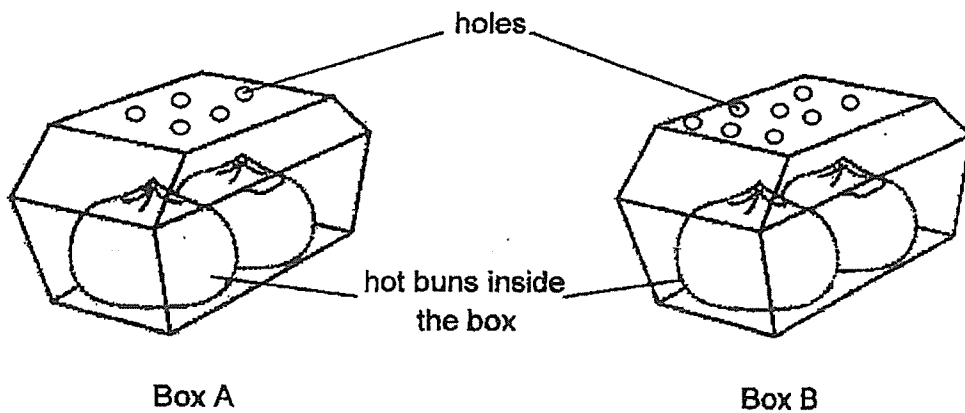

- (b) When she opened the boxes, she observed that the buns in box A were wetter than the buns in box B. Explain why. [1]

Score	3
-------	---

35. Mary conducted an experiment as shown in the diagram below.

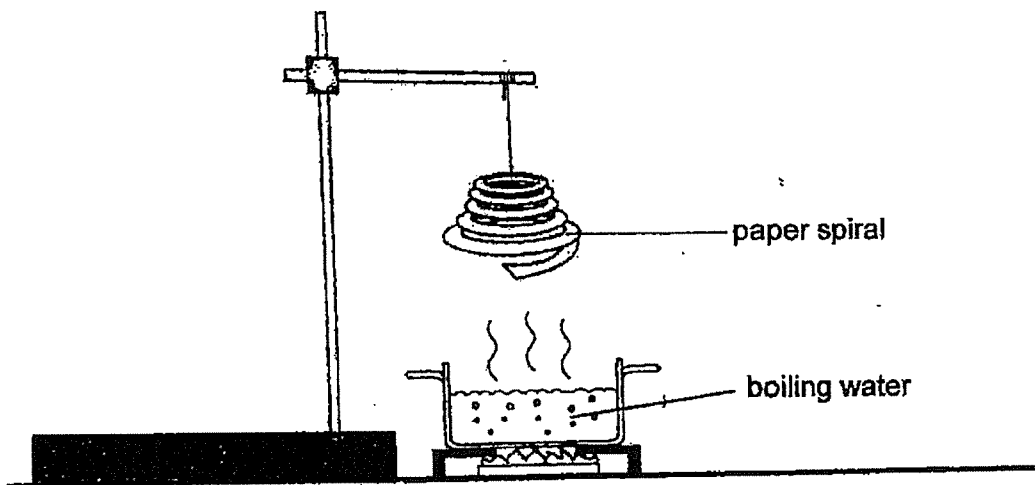

A paper spiral was hung above the pot of boiling water. After some time, the paper spiral started to spin.

(a) Fill in the blanks below to show the energy conversion. [1]

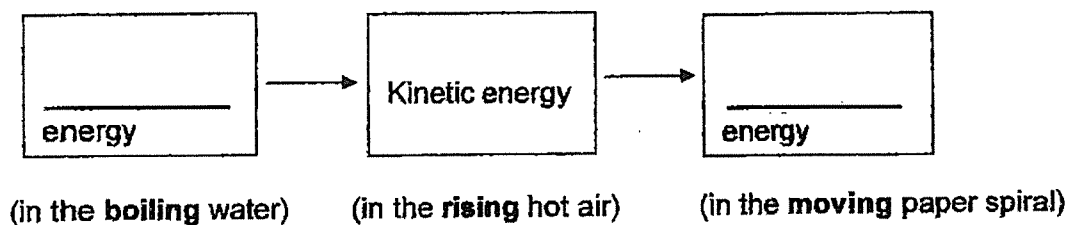

8

Score	1
--------------	---

Mary decided to repeat the same experiment to find out how the exposed surface area of a container affected the average number of spins made by the paper spiral in one minute.

The table below showed the results.

Exposed surface area of container (cm ²)	Average number of spins (per minute)
200	3
400	5
600	8
800	12

- (b) Based on the results above, state how the average number of spins is affected by the exposed surface area of the container. [1]

- (c) Twenty holes were punched on the same paper spiral and the experiment was conducted again using a container with an exposed surface area of 800 cm².

- (i) How would this change affect the average number of spins made by the paper spiral? [1]

- (ii) Explain your answer in part (i) [1]

Score	3
-------	---

36. Lisa wants to find out how well the remote control switches on the television when different objects are put in front of it. She holds a piece of writing paper in front of the remote control and is able to turn on the television.

Then, with every step she walks backward, she turns on and off the television using the remote control until the remote control cannot turn it on. She repeats the same steps with different objects.

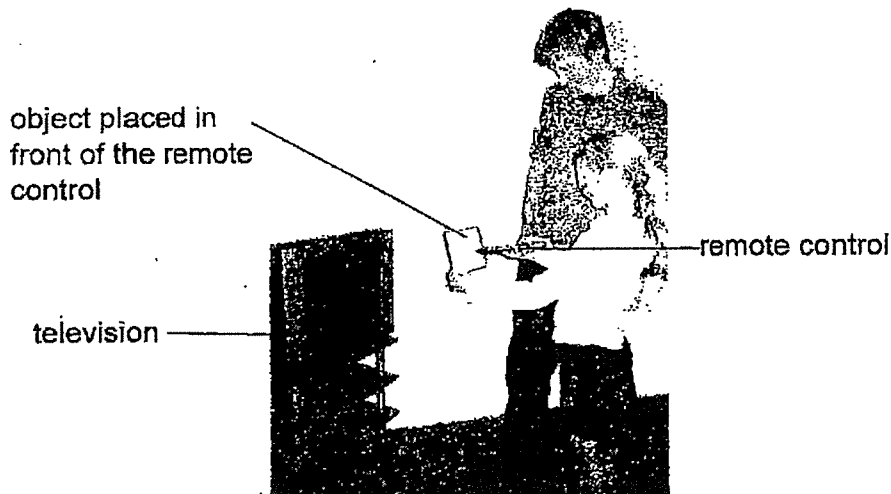

The table below shows her results.

Object	Distance from TV before the remote control does not work (number of steps)
foolscap paper	7
clear plastic bag	20
aluminium foil	0
tracing paper	10
book	0

- (a) Lisa's elder brother says that she should not use the book to test as it is unfair. Give a reason why he thinks so. [1]

Score	1
--------------	---

- (b) Lisa's brother repeats the experiment to check the results. For each object, he takes fewer steps than Lisa before he is not able to use the remote control to switch on the television.

Suggest a reason why this happens.

[1]

- (c) Suggest one change to obtain more accurate results in finding the distance from the television before the remote control does not work.

[1]

- (d) Lisa sees a pattern in her results. She concludes that remote control uses light to switch on the television.

How did Lisa conclude from the data collected that remote control uses light to work?

[1]

Score	3
-------	---

37. Ray set up the experiment shown below.

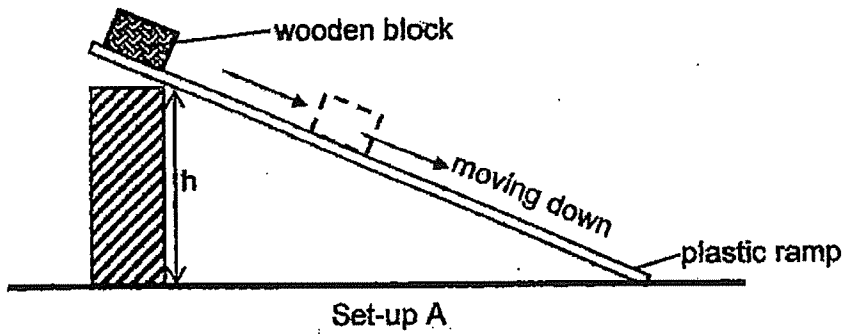

He released the wooden block from the top of the ramp and measured the distance travelled by the block and the time taken. His results are shown in the graph below.

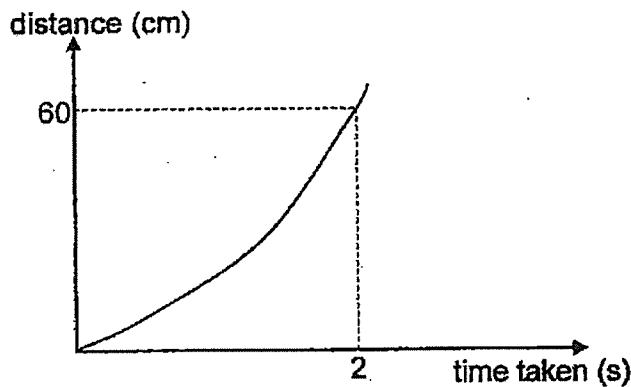

Ray repeated the experiment by applying oil to the surface of an identical ramp.

- (a) State which graph, P, Q, R or S, correctly represents the set-up with oil added to the ramp. [1]

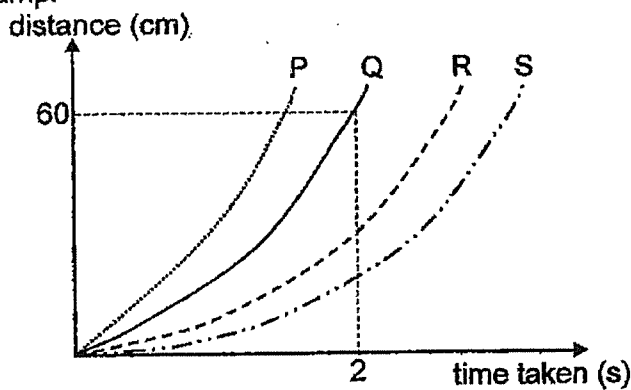

Graph: _____

Score	1
--------------	---

(b) Explain why you chose the graph in (a).

[2]

(c) Without changing the plastic ramp, suggest one change to set-up A so that the wooden block will take a longer time to reach the bottom of the plastic ramp. [1]

Score	3
-------	---

38. The diagram below shows a bow and arrow and when the string of the bow was pulled back 30cm from its original position.

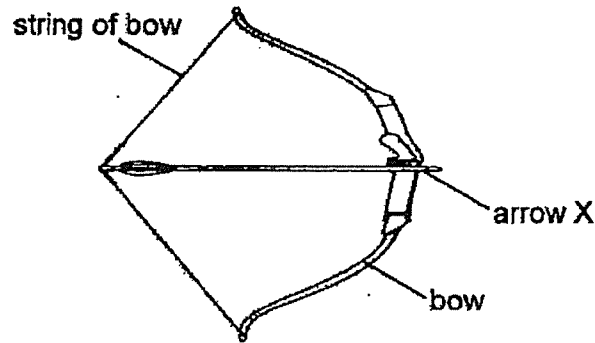

- (a) Write down the forces acting on arrow X. [1]

When the string was released, arrow X travelled in the path as shown below before hitting the ground at point K.

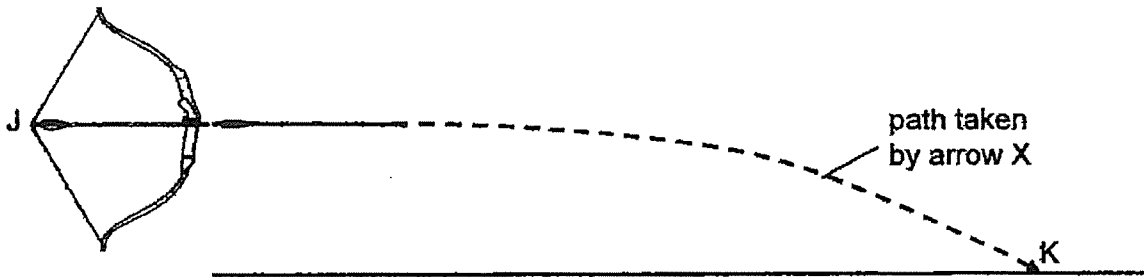

- (b) In terms of forces, explain the movement of arrow X from the point it was released at J till it hit the ground at K. [2]

- (c) The activity was repeated with a similar-sized arrow, Y, of a greater mass. Draw the path taken by arrow Y in the diagram above. [1]

Score	4
--------------	---

39. Vanda wanted to find out how different amount of light affect the rate of photosynthesis. She used three similar glass containers and wrapped each container with different materials, X, Y and Z. She then covered the opening of each container with thick cardboard as shown below.

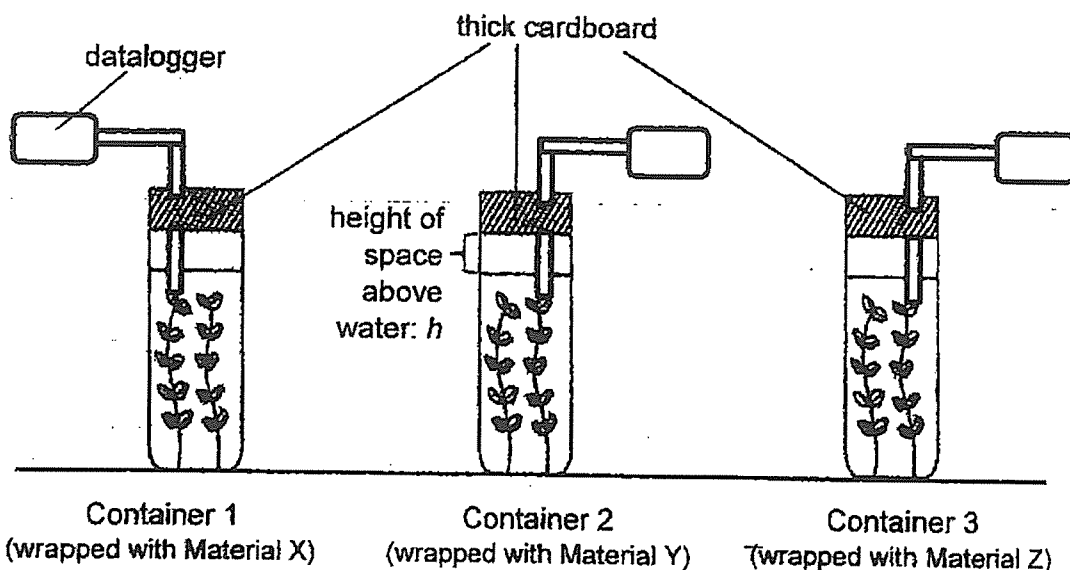

To measure the amount of carbon dioxide present in the water, she added a sensor into each container to measure the amount of carbon dioxide using a data logger. She then left the set-ups near the window for 4 hours and obtained the results as shown below.

Material	Initial amount of carbon dioxide (units)	Final amount of carbon dioxide (units)
X	12	1
Y	12	17
Z	12	5

- (a) Based on the results above, put a tick (✓) in the correct column to indicate if each of the following statements is 'True' or 'False'. [2]

	Statement	True	False
(i)	Z could be made of cardboard.		
(ii)	Y is most likely a translucent material.		
(iii)	Z allows less light to pass through than X.		
(iv)	X can be used to make a windscreen of a car.		

- (b) Vanda wanted to grow fully submerged water plants in a tank. Based on the results above, which one of the above materials is best suited for making the tank? Explain your choice. [1]

Score	3
-------	---

40. Melissa set up an experiment shown below where a wire was coiled around an iron bar in the circuit shown below.

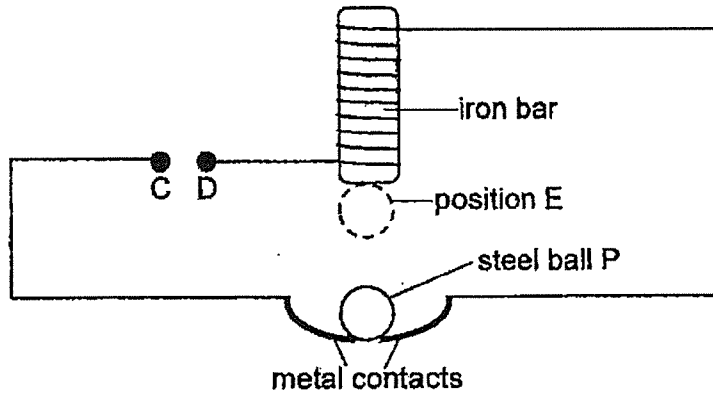

An object Y was used to connect point C to D in the circuit. Melissa observed that ball P moved repeatedly between the iron bar and the metal contacts until object Y was removed.

- (a) What is object Y? [1]

- (b) When object Y was connected between points C and D, explain how ball P moves to position E? [2]

Score	3
-------	---

Melissa then added bulb A to the same set-up, as shown below.

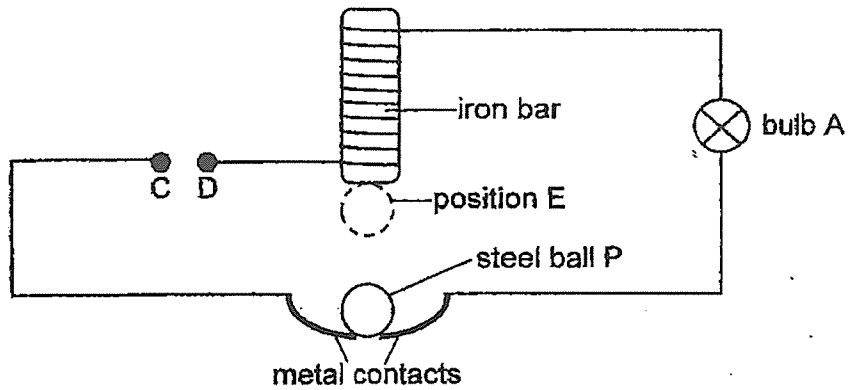

- (d) When object Y was placed between points C and D, describe what will Melissa observe for Bulb A when ball P moved repeatedly between the iron bar and the metal contacts? [1]

End of Booklet B

Score	1
-------	---

YEAR : 2023
 LEVEL : PRIMARY 6
 SCHOOL : TAO NAN SCHOOL
 SUBJECT : SCIENCE
 TERM : COMMON-TIMED PRACTICE

(BOOKLET A)

Q1	3	Q2	4	Q3	3	Q4	3	Q5	4
Q6	1	Q7	4	Q8	1	Q9	3	Q10	2
Q11	1	Q12	1	Q13	3	Q14	3	Q15	2
Q16	3	Q17	3	Q18	1	Q19	3	Q20	2
Q21	2	Q22	1	Q23	1	Q24	3	Q25	4
Q26	3	Q27	1	Q28	2				

(BOOKLET B)

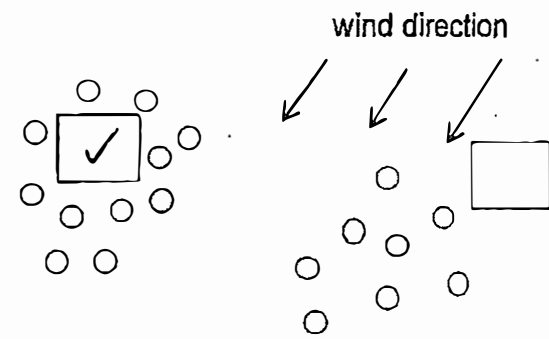
Q29	a)	(i) System 1: Muscular system (ii) System 2: Skeletal System			
	b)	Oxygen and digested food			
	c)	Heart, blood, blood vessels			
Q30	a)	(B), (C), (A)			
	b)	More oxygen and warmth			
	c)	The oxygen produced by the floating water plants during photosynthesis is released into the atmosphere not into the water.			
Q31	a)	Fruit R dispersed its seeds by explosive and by wind. The seeds of fruit R were light with transparent wings to allow it to stay in the air for a longer time and the fruit wall of fruit R splits open forcefully when ripe and be dispersed far away from the parent plant			
	b)	(i)  (ii) Fruit Q is dispersed by explosive action. Hence, the seeds are clustered around the parent plant.			
Q32	a)	5 food chains			
	b)	Food producer	Plant-eater	Plant and animal-eater	Animal eater
		W	U	X	V,Z,Y
c)	Organism Y can adapt and feed on V.				

Q33	a)	(i) Animal R feeds on the sweet substance produced by animal S. (ii) Animal S would get protection from animal R against other insects. S gets protection from predators.			
	b)				
	c)	The population of animal S would decrease. There would be less animal R to fight off attacks from other insects that feed on animal S.			
Q34	a)	Warm water vapour from the buns in the box came into contact with the cooler surface of the box, lost heat and condensed into water droplets which dripped back onto the buns.			
	b)	Less warm water vapour in Box A could escape as there were less holes on Box A than Box B. Hence, more warm water vapour in Box A condensed and the buns in box A were wetter.			
Q35	a)	Heat → Kinetic energy → Kinetic energy			
	b)	As the exposed surface area of the container increases, the average number of spins increase.			
	c)	(i) The average number of spins made by the paper spiral decrease. (ii) The paper spiral will have less exposed surface area to the rising hot air, hence, less kinetic energy will be transferred from the hot air to the paper spiral.			
Q36	a)	The book is of a different thickness as compared to the other objects.			
	b)	Lisa's brother took a larger steps than Lisa.			
	c)	Use a ruler to measure the distance.			
	d)	The remote control only works with objects that allow light to pass through.			
Q37	a)	Graph: P			
	b)	Oil reduced friction between the block and the ramp, Hence, the block travelled down the ramp faster.			
	c)	Decrease the height of h			
Q38	a)	Elastic spring force and frictional force			
	b)	The string when released exerted elastic force on X to move it forward. X fell to the ground as gravity was acting on it			
Q39	a)	(i)	(ii)	(iii)	(iv)
		False	False	Truth	Truth
	b)	Material X. It allowed the most light to pass through. Hence, the fully submerged water plants could trap the most light to photosynthesis and make the most food.			
Q40	a)	Battery			
	b)	A closed circuit is formed. The iron bar become an electromagnetic. It attracted metal ball P as it is made of an magnetic material.			
	c)	When object Y is placed between points C and D, Bulb A would blink repeatedly.			

2
END