

Red Swastika School
Primary 6 Science 2023
Class Test 2

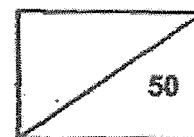

Name: _____ () Parent's Signature: _____

Class: _____ Date: _____

Total time for Sections A and B: 50 minutes

Section A: Multiple – Choice Questions (14 x 2 = 28 marks)

Choose the most suitable answer and shade its number in the OAS provided.

1. A student made three statements about sexual reproduction in humans:

- A The male reproductive cell is produced in the penis.
- B Fertilisation occurs in a female reproductive part.
- C The fertilised egg is found in the ovary.

Which statement(s) is/are true?

- (1) B only
- (2) A and C only
- (3) A and B only
- (4) B and C only

2. Which gases are found in air?

- A oxygen
- B nitrogen
- C water vapour
- D carbon dioxide

- (1) A and D only
- (2) B and C only
- (3) A, C and D only
- (4) A, B, C and D

3. The diagram below shows the different parts of a flower.

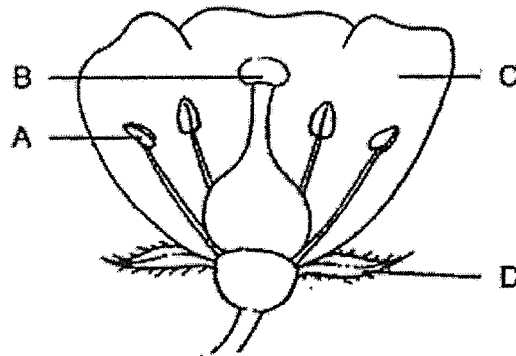

Darrick removed one part, A, B, C or D, from the flower. After some time, the flower did not develop into a fruit.

Which part of the flower did Darrick remove?

- (1) A
- (2) B
- (3) C
- (4) D

4. Study the three different cells shown below.



A

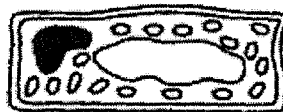

B



C

Which of the following statements is true about cells A, B and C?

- (1) Cells B and C are animal cells.
- (2) Only cell B can make its own food.
- (3) Cells A, B and C have a fixed shape.
- (4) Cell B can only be found in the roots of a plant.

5. On a sunny day, David placed two similar plastic cones, Y and Z, on a tray of wet sand as shown below.

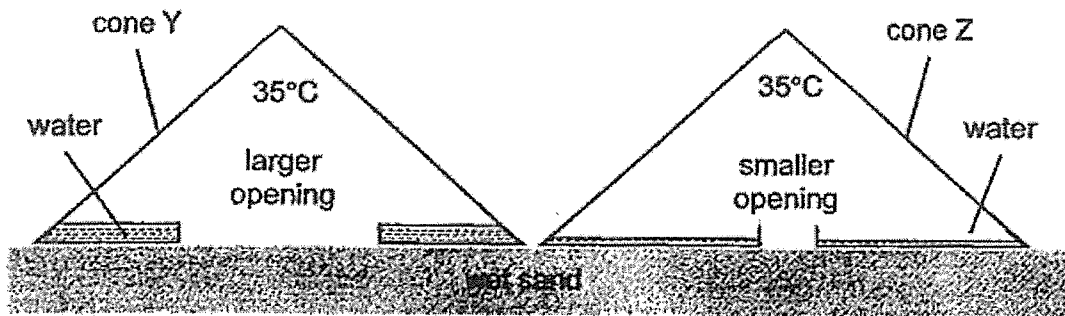

At the end of the day, David observed that cone Y had collected more water than cone Z.

What was the hypothesis tested in this experiment?

- (1) Rate of condensation is faster when there is more water in the wet sand.
- (2) Rate of evaporation is faster when the temperature inside the cones is higher.
- (3) Rate of evaporation is faster when the exposed surface area of the wet sand is larger.
- (4) Rate of condensation is faster when the materials of cones Y and Z are different.

6. The diagram below shows the direction of blood flow in some parts of the body.

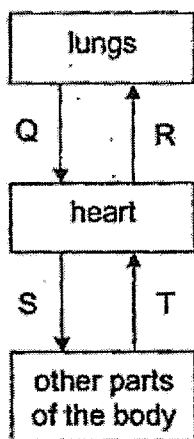

The same amount of blood was taken from Q, R, S and T. Which chart shows the correct comparison of the amount of oxygen in the blood samples?

(1)

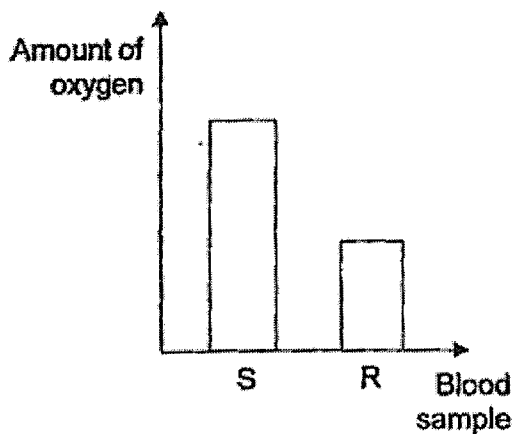

(3)

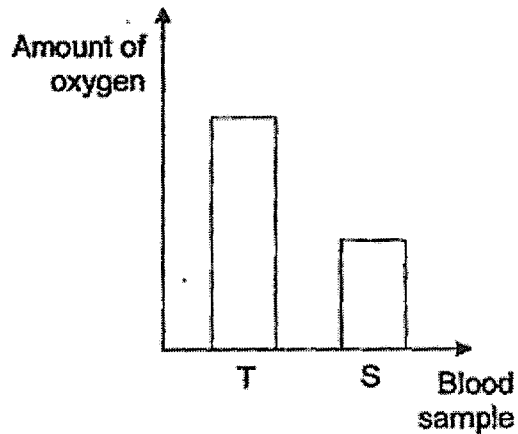

(2)

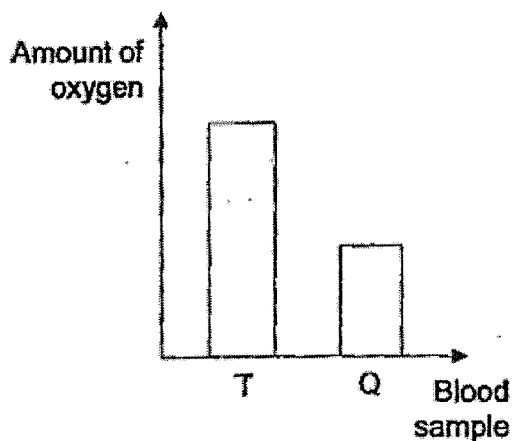

(4)

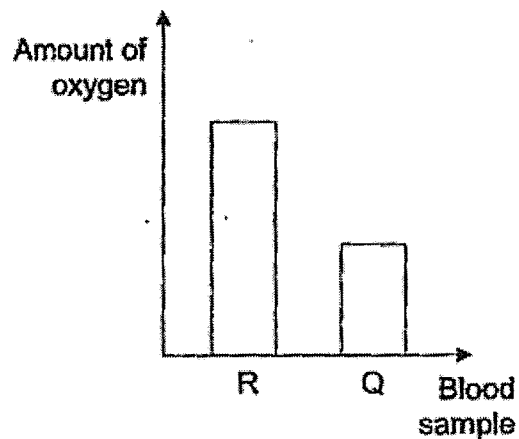

7. The diagram below shows how food and water are transported within a plant. X, Y and Z represent different parts of the plant.

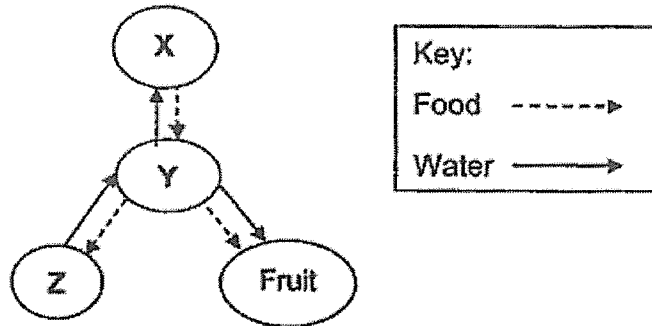

Which of the following correctly identifies the plant parts represented by X, Y and Z?

	X	Y	Z
(1)	stem	leaves	roots
(2)	stem	roots	leaves
(3)	leaves	roots	stem
(4)	leaves	stem	roots

8. Study the circuit below.

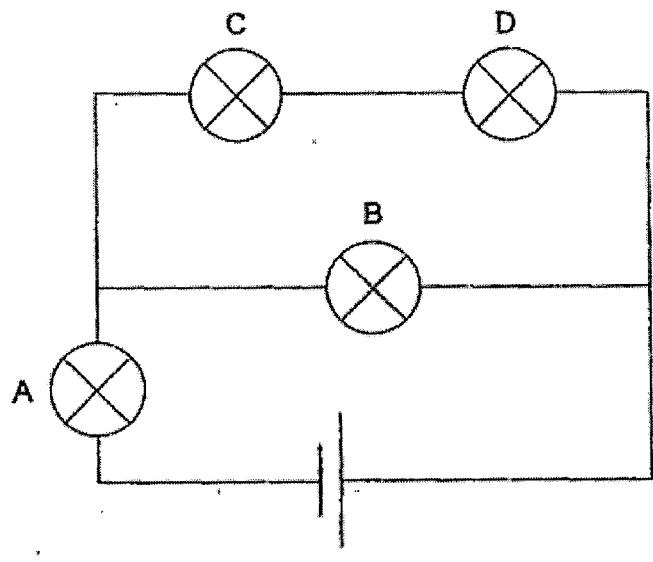

One of the bulbs was blown and three bulbs remained lit.
Which bulb was blown?

- (1) A
- (2) B
- (3) C
- (4) D

9. Tim went on a rollercoaster ride with his friends. Certain points of the roller coaster have been labelled as A, B, C and D.

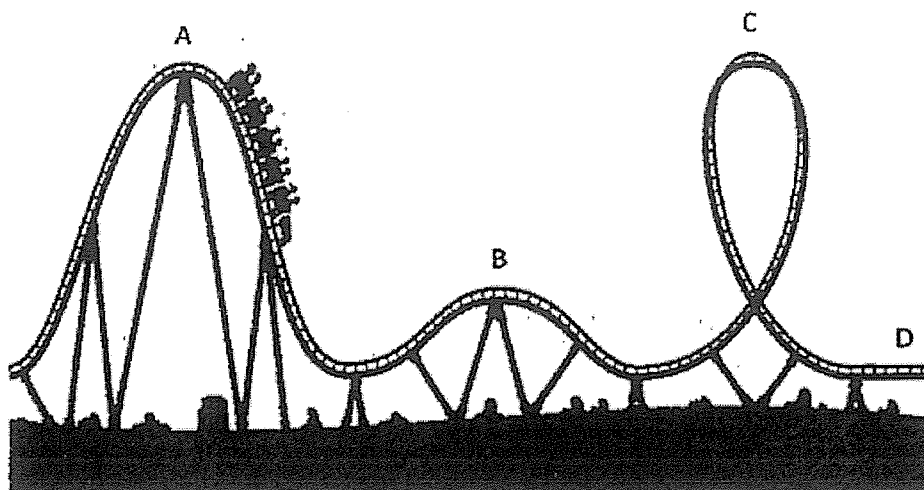

Which of the following statements about the four points is/are correct?

- A There is greater kinetic energy at point B than at point C.
 - B There is greater potential energy at point D than at point B.
 - C The kinetic energy of the rollercoaster is the highest at point D.
 - D The rollercoaster has more potential energy at point A than at point D.
- (1) A only
(2) B and D only
(3) C and D only
(4) A, C and D only

10. Khidhir set up a circuit as shown. When he closed the switch, he observed that only bulb L lit up.

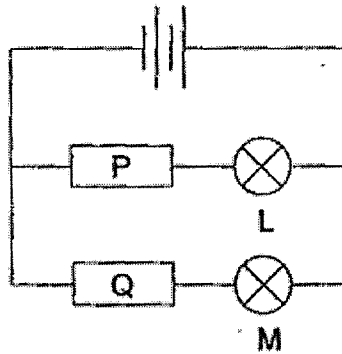

He then exchanged P with Q and observed that no bulb lit up.

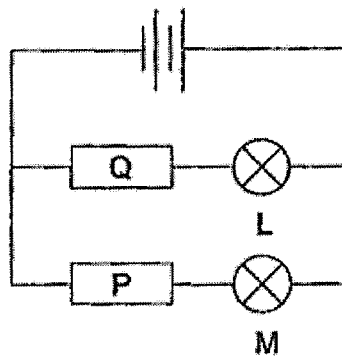

Which of the following is correct?

	Conductor of electricity	Fused bulb
(1)	Q	M
(2)	Q	L
(3)	P	M
(4)	P	L

11. Study the food web below.

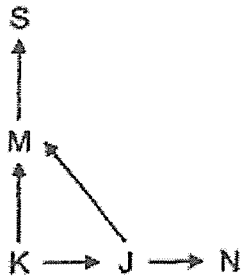

Which statement is correct?

- (1) N is a plant and animal eater.
- (2) M is a plant eater.
- (3) J is a plant eater.
- (4) S is a producer.

12. Bala placed the tank below next to an open window.

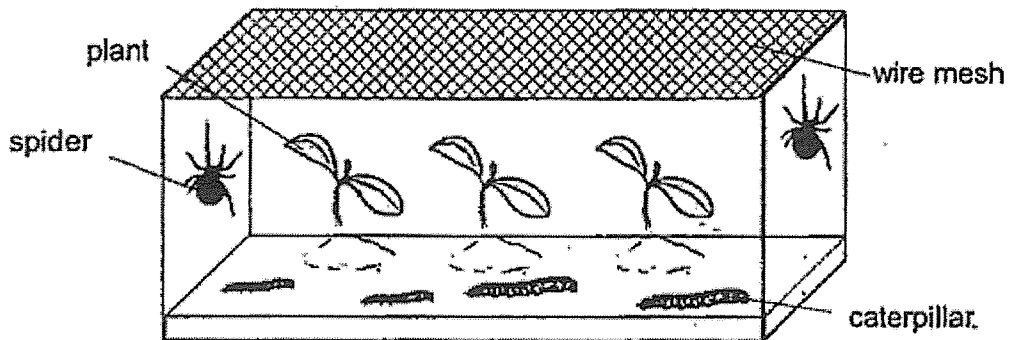

Which of the following is correct?

- (1) The spiders form two populations.
- (2) The caterpillars form one community.
- (3) The tank forms one population for the organisms.
- (4) The plants, spiders and caterpillars form one community.

13. Clara conducted an experiment in a dark room using the set-up below. She measured the amount of gas collected in the measuring cylinder after some time.

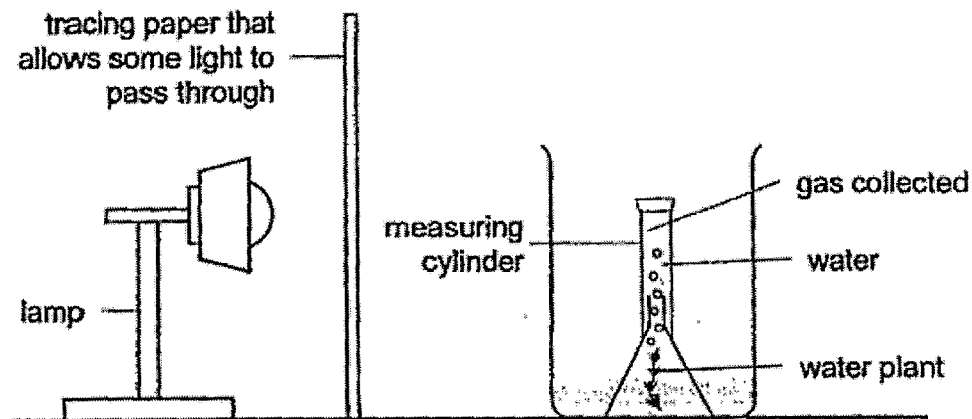

Clara repeated her experiment by increasing variable X and keeping all other variables constant. Her results are shown below.

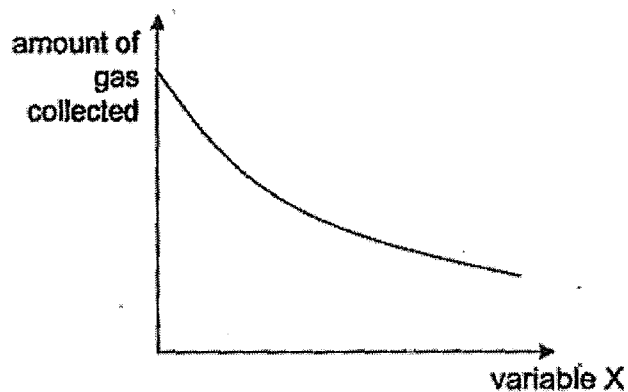

What could be variable X?

- (1) number of water plants
- (2) volume of water in the set-up
- (3) number of sheets of tracing paper
- (4) number of lamps shining on the water plant

14. In a modified game, Jeremy swings from position X to position Y. At position Y, he scores a point if he kicks the ball that is attached to a spring fixed to the ground.

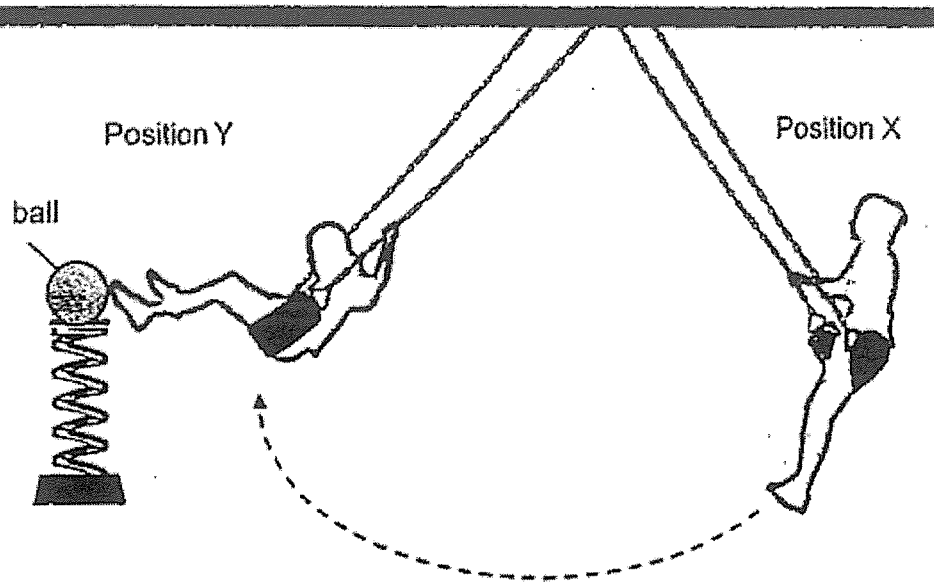

Which of the following shows the correct conversion of energy when Jeremy swings from position X and scores a point?

- (1) potential energy of the player \longrightarrow potential energy of the ball \longrightarrow kinetic energy of the ball
- (2) potential energy of the player \longrightarrow kinetic energy of the player \longrightarrow kinetic energy of the ball
- (3) kinetic energy of the player \longrightarrow potential energy of the player \longrightarrow kinetic energy of the ball
- (4) kinetic energy of the player \longrightarrow kinetic energy of the player \longrightarrow potential energy of the ball

Section B: Open-Ended Questions (22 marks)

Answer all the questions in the space provided.

15. A farmer grew young plants far apart from one another.

(a) Why did the farmer grow the young plants far apart from one another? (1m)

A farmer had two different seeds, P and Q. He placed a fan at the side to ensure that the wind speed is the same. The farmer released the seeds from the same height, d , as shown in the diagram below.

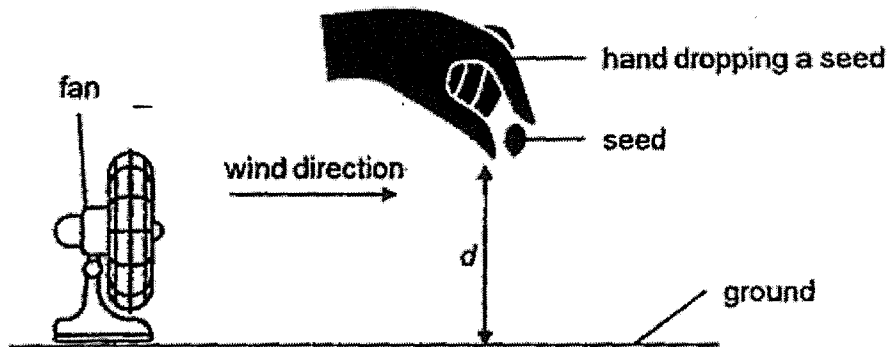

He recorded the time taken for each seed to reach the ground in the table below.

Type of seed	P	Q
Time taken (s)	5	25

(b) Based on the information given above, what can be concluded about seed Q's method of dispersal? (1m)

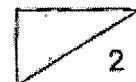

16. Siti observed a block of ice changing to water as shown below.

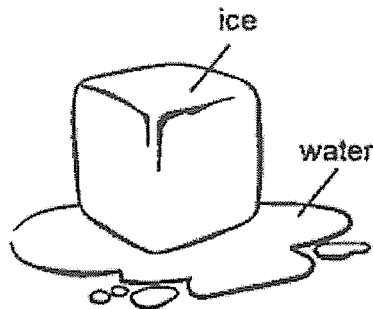

- (a) Name the process observed by Siti. (1m)

Siti placed blocks of ice in a thick plastic box as shown below. She placed bottles of drinks into the plastic box and brought the box with her on a jog.

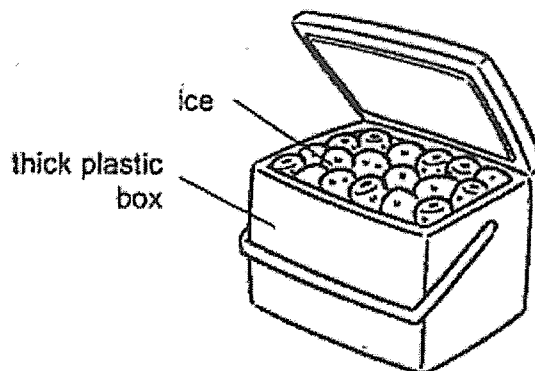

- (b) Explain how the box prevents ice from changing into water quickly. (1m)

After her 30-minutes jog, Siti splashed some water from the box onto her face to cool her face down. When a strong wind blew, Siti's face felt even cooler.

- (c) Explain why Siti's face felt cooler when the strong wind blew. (2m)

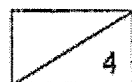

17. The diagram below shows how water and food are transported in a plant.

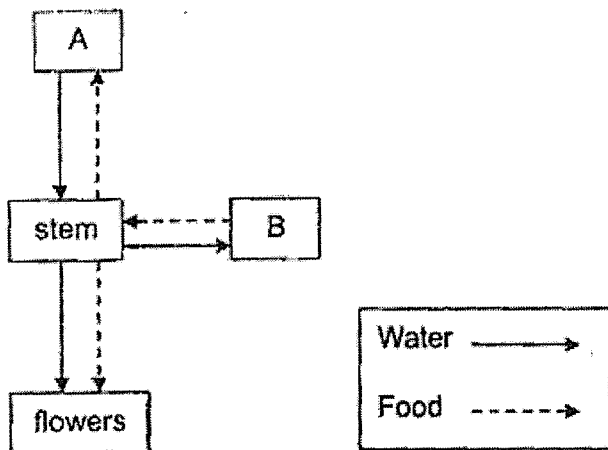

(a) Which parts of the plant do A and B represent? (1m)

A: _____

B: _____

The outer ring of the stem of the plant was removed. The food-carrying tubes were removed while the water-carrying tubes remained in the stem.

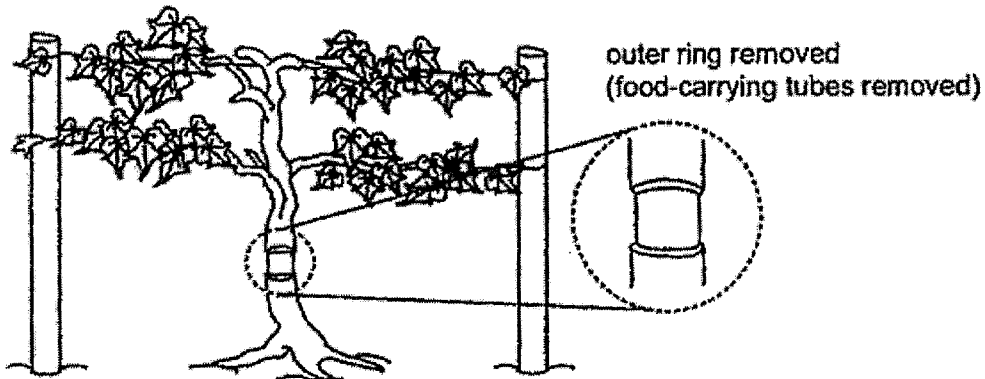

(b) A week later, the plant withered and died. Give a reason why removing the outer ring of the stem caused the plant to die. (2m)

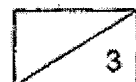

18. Ellie set up the circuit as shown.

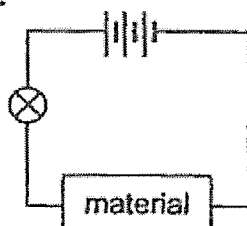

She used different materials in the circuit above and observed whether the bulb lit up. She recorded his results in the table below.

Material	Did the bulb light up?
S	Yes
T	Yes
U	No
V	Yes

(a) What can be concluded about the materials? (2m)

Study the circuit diagram.

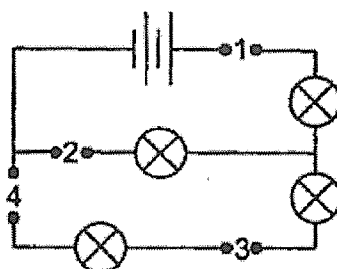

(b) The numbers 1 to 4 represent the locations where materials S, T, U and V can be placed in the circuit. All the materials must be used and each material can only be used once. In the tables below, fill in where you can place materials S, T, U and V such that the most-number of bulbs will light up. (2m)

Position	1	2	3	4
Material				

4

19. Study the food chain below.

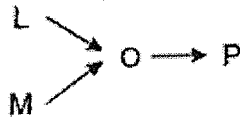

(a) If the whole population of O is killed, would the populations of L and P increase or decrease? (1m)

Population of L: _____

Population of P: _____

After several years, pollution caused the population of organism P to decrease.

(b) Based on the information and the food chain above, what would happen to the population size of organism L after several years? Explain why. (2m)

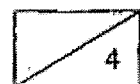

The diagram below shows organisms L and M. Organism L is white and organism M is black. Organisms L and M frequently rest on tree trunks.

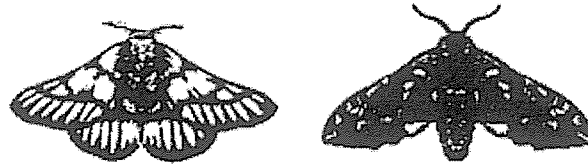

organism L

organism M

The bark of tree trunks in Town Z was light in colour.

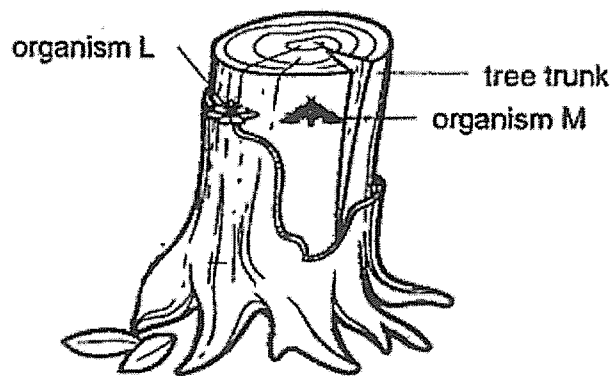

(c) Which organism would survive better in Town Z? Explain your answer. (1m)

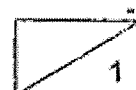

20. Sarah carried out an investigation using two rocks. She rubbed the two rocks against each other as shown below.

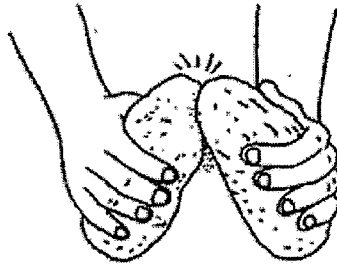

After five minutes, Sarah felt that the surface of the rocks were hot. She measured the temperature of the surface of the rocks. The results are shown below.

Attempts	Temperature of surface of rocks (°C)	
	before rubbing	after rubbing
1	20	35
2	20	34
3	20	36

- (a) Explain why Sarah repeated her experiment three times. (1m)

- (b) Fill in the blanks below to show the energy conversion. (2m)

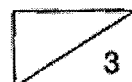
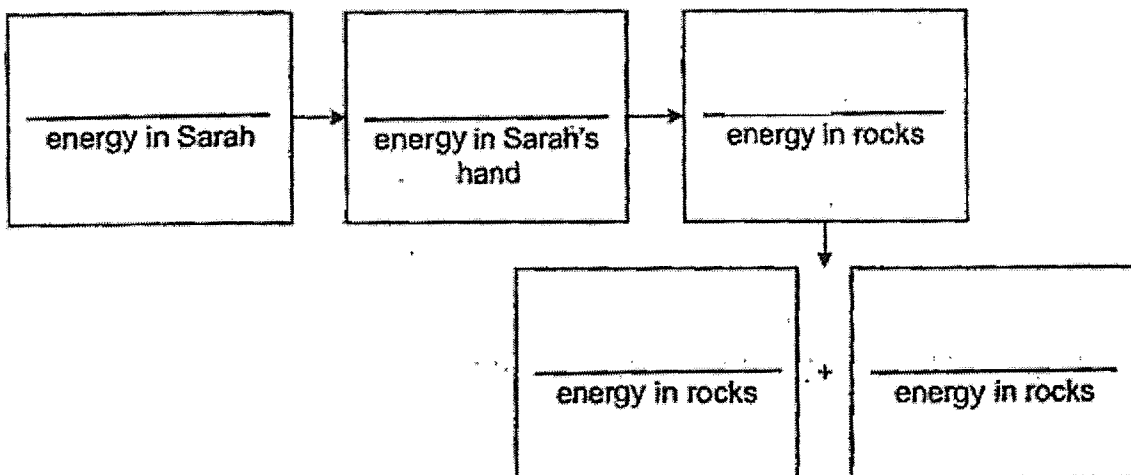

Sarah decided to rub the two rocks at a faster rate. After 5 minutes, the temperature of the surface of the rocks was 50°C.

- (c) Explain, in terms of energy conversion, why the temperature of the surface of the rocks was higher when Sarah rubbed the rocks faster. (2m)

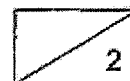

End of paper
Please check your answers

YEAR : 2023
 LEVEL : PRIMARY 6
 SCHOOL : RED SWASTIKA SCHOOL
 SUBJECT : SCIENCE
 TERM : CLASS TEST 2

CLASS TEST 2

Q1	1	Q2	4	Q3	2	Q4	2	Q5	3
Q6	1	Q7	4	Q8	2	Q9	4	Q10	3
Q11	3	Q12	4	Q13	3	Q14	2		

Q15	a)	To prevent competition for light, water and space.							
	b)	Seed Q is dispersed by wind.							
Q16	a)	Melting							
	b)	Plastic is a poor conductor of heat. The box will slow down the ice from gaining heat from the surroundings.							
	c)	Water on Siti's face gained heat from her face and evaporated. When the strong wind blew, the rate of evaporation increased. Thus, Siti's face lost heat more quickly.							
Q17	a)	A: Roots B: Leaves							
	b)	When the food-carrying tubes were removed, food made in the leaves could not be transported to the roots of the plant. Thus, the roots died and could not take in water. Thus, the plant died.							
Q18	a)	Materials S, T and V are electrical conductors while material U is an electrical insulator.							
	b)	Position	1	2	3	4			
		Material	S	U	T	V			
Q19	a)	Population of L: increase Population of P: decrease							
	b)	When population of P decreases, there would be less P to eat O. Thus, the population of O will increase. More O will eat L. Thus, the population of L will decrease.							
	c)	Organism L as L is able to camouflage with the tree trunk better than M.							
Q20	a)	So that Sarah can get a more reliable result.							
	b)	Potential → Kinetic → Kinetic → Heat + Sound							
	c)	When Sarah rubbed the rocks faster, more kinetic energy in Sarah is converted to more kinetic energy in the rock. More kinetic energy in the rock is converted to more heat energy on the surface of the rocks.							

