



Rosyth School
Preliminary Examination 2023
SCIENCE
Primary 6

Name: _____

Total

Marks:

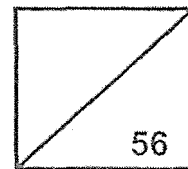

Class: Pr 6 _____

Register No. _____

Date: 24 August 2023

Duration: Total time for Booklets A and B: 1 h 45min

Booklet A

Instructions to Pupils:

1. Please do not turn this page until you are told to do so.
2. Follow all instructions carefully.
3. Answer all questions.
4. This paper consists of 2 booklets, Booklet A and Booklet B.
5. For questions 1 to 28 in Booklet A, shade the correct ovals on the Optical Answer Sheet (OAS) provided using a 2B pencil.

This booklet consists of 25 printed pages (including this cover page).

This paper is not to be reproduced in part or whole without the permission of the Principal.

For each question from 1 to 28, four options are given. One of them is the correct answer. Make your choice (1, 2, 3 or 4). Write the correct answer in the OAS provided.

(56 Marks)

1 Which one of the following statements is true about mushrooms, ferns and moulds?

- (1) All are decomposers.
- (2) All cannot make food.
- (3) All need to grow in soil.
- (4) All reproduce from spores.

2 The diagram shows a leaf cell with parts labelled 1 to 4. In which part of the cell does photosynthesis take place?

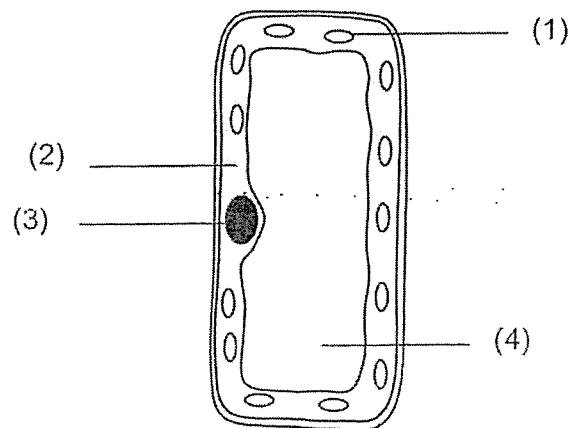

3 The diagram below shows a shoot growing from a potato.

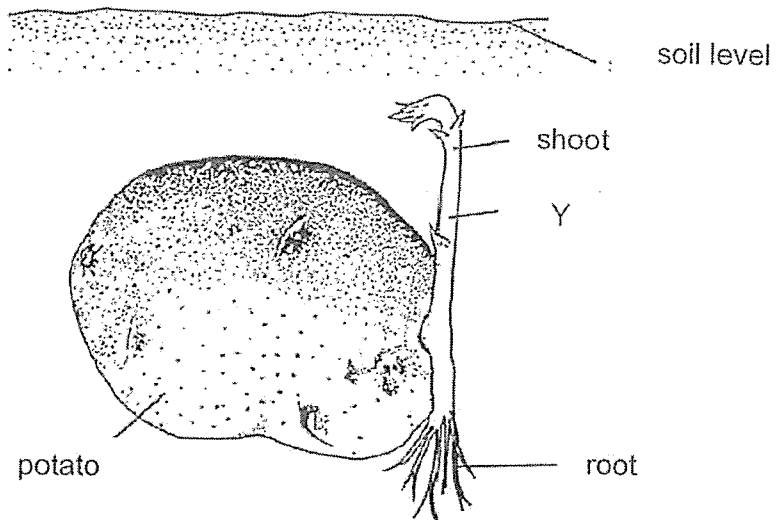

What is the direction in which food and water are being transported at Y?

Direction for transport of	
food	water
(1) upwards	upwards
(2) upwards	downwards
(3) downwards	upwards
(4) downwards	downwards

- 4 Mr Tan measured the rate of oxygen absorbed by the lungs into the bloodstream of two men, Ali and Ahmad. The measurements were taken when the men's breathing rates were the same.

The results are shown in the table below.

	Oxygen absorbed into the bloodstream (cm^3/min)
Ali	22
Ahmad	12

Which statement best explains the above results?

- (1) Ali has damaged air sacs in the lungs.
- (2) Ali has a smaller lung volume than Ahmad.
- (3) Ahmad has damaged air sacs in the lungs.
- (4) Ali is exercising at a faster rate than Ahmad.

- 5 Brinda conducted a fair experiment by dropping seed P from a height and measured the distance travelled by the seed as shown below.

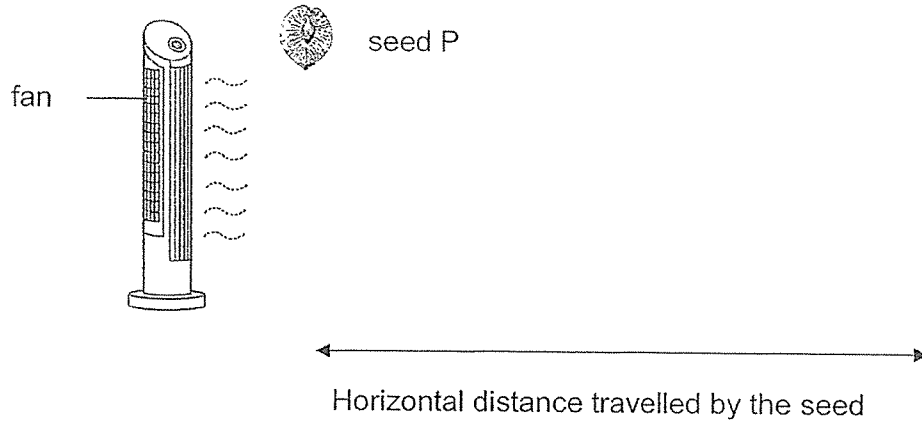

She repeated the experiment with different types of seeds, Q, R and S. She kept the other variables the same for a fair experiment.

Brinda presented her findings in the table below.

Seed	Types of seeds			
	P	Q	R	S
Mass of each seed (g)	2	2	5	5
Average distance travelled from the fan (cm)	76	0	76	27

Which one of the following affected the distance travelled by the seeds, P, Q, R and S?

- (1) Wind speed
- (2) Air resistance
- (3) Potential energy
- (4) Gravitational force

- 6 Four students compared the functions of the human circulatory system and the plant transport system as shown below.

Student	Comparison statements	
	Human circulatory system	Plant transport system
Lara	Transports water, oxygen, carbon dioxide and digested food	Transports water, carbon dioxide and food
Ming	Transports food and water in separate blood vessels	Transports food and water in separate tubes
Olivia	Transports substances that are absorbed into the blood	Transports mineral salts that are dissolved in the water
Panya	Circulates water in the body	Transports water to the upper parts of the plant

Which students made the correct comparison statements?

- (1) Lara and Ming only
- (2) Olivia and Panya only
- (3) Olivia, Lara and Ming only
- (4) Olivia, Ming and Panya only

7 The diagram below shows the plant reproductive system.

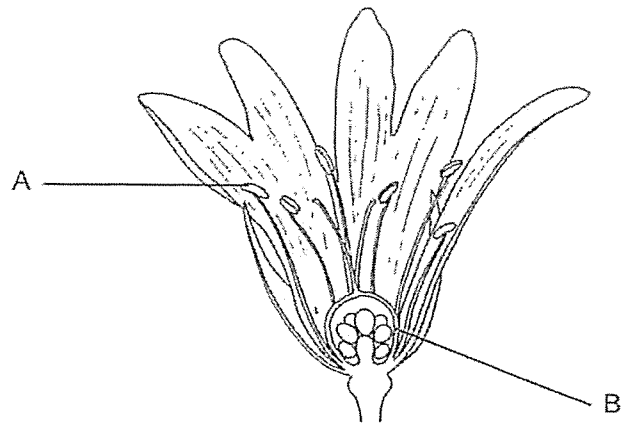

Which parts of the human reproductive system have the same functions as parts A and B of the plant reproductive system?

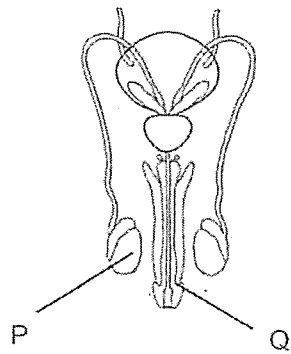

Male

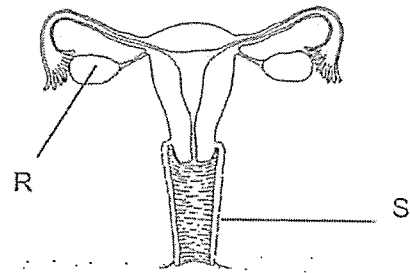

Female

	Part A	Part B
(1)	P	R
(2)	P	S
(3)	Q	R
(4)	Q	S

8 The diagram below shows the life cycle of an animal.

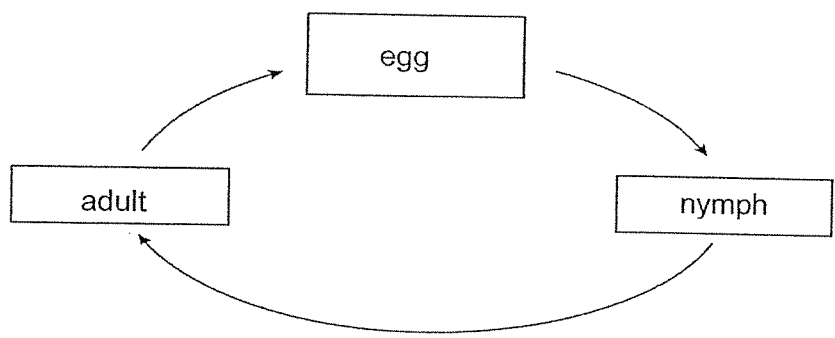

Which animal is likely to have the life cycle as shown above?

- (1) Frog
- (2) Chicken
- (3) Grasshopper
- (4) Mealworm beetle

- 9 Dengue is spread by the Aedes mosquito. Researchers kept some mosquitoes in different temperatures and measured the number of days per stage as shown in the table below.

Temperature (°C)	Number of days per stage		
	Egg	Larva	Pupa
W	2	6	2
X	2	8	2
Y	2	7	2
Z	2	10	2

At which temperature, will there be most likely the highest number of dengue cases?

- (1) W
- (2) X
- (3) Y
- (4) Z

- 10 Muthu studied the rate of photosynthesis of a plant in different conditions. His results are as shown.

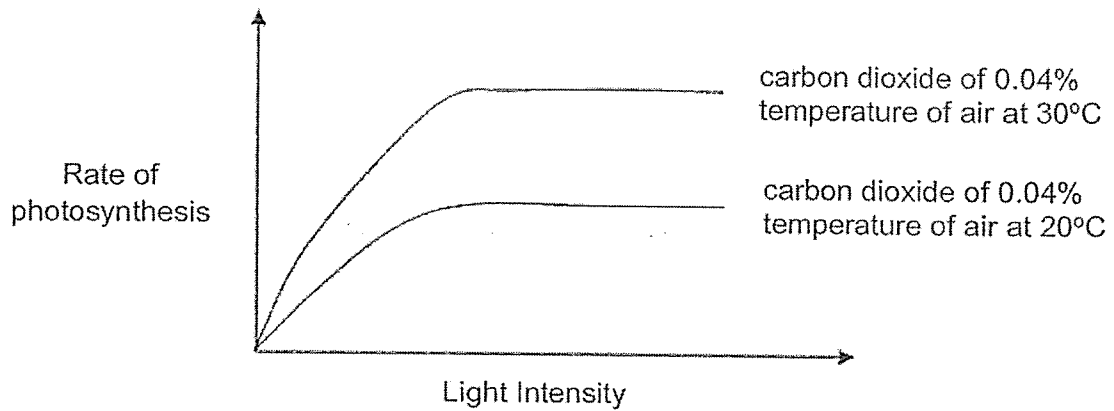

What conclusion can Muthu make from his study?

- (1) The amount of light intensity does not affect the rate of photosynthesis.
- (2) The higher the temperature of air the higher the rate of photosynthesis.
- (3) The amount of carbon dioxide does not affect the rate of photosynthesis.
- (4) The higher the amount of light intensity the higher the rate of photosynthesis.

11 Which of the following shows the exchange of gases in plants and animals correctly?

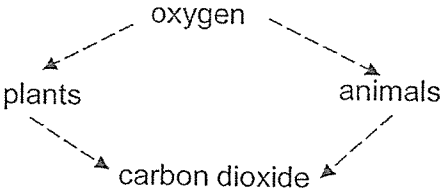
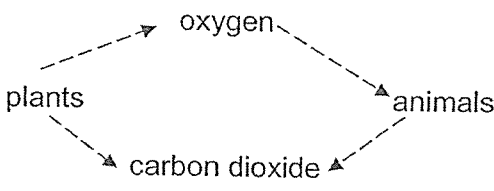
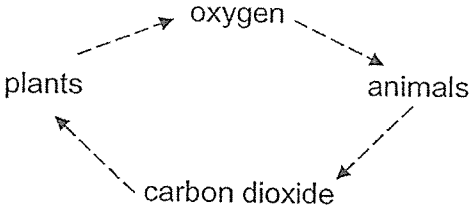
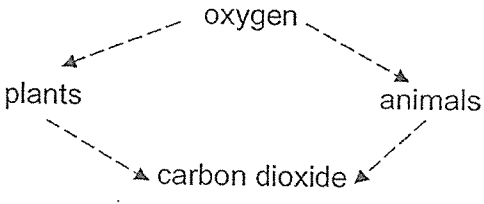
Presence of light	Exchange of gases
(1) Yes	 <pre> graph TD O2[oxygen] --> P[plants] P --> CO2[carbon dioxide] CO2 --> A[animals] A --> O2 </pre>
(2) Yes	 <pre> graph TD O2[oxygen] --> P[plants] P --> CO2[carbon dioxide] CO2 --> A[animals] A --> O2 </pre>
(3) No	 <pre> graph TD O2[oxygen] --> P[plants] P --> CO2[carbon dioxide] CO2 --> A[animals] A --> O2 </pre>
(4) No	 <pre> graph TD O2[oxygen] --> P[plants] P --> CO2[carbon dioxide] CO2 --> A[animals] A --> O2 </pre>

- 12 Lenny wanted to find out how different soils will affect the amount of water passing through. She prepared four set-ups as shown below. In each set-up, she poured 100ml of water into each soil, P, Q, R and S.

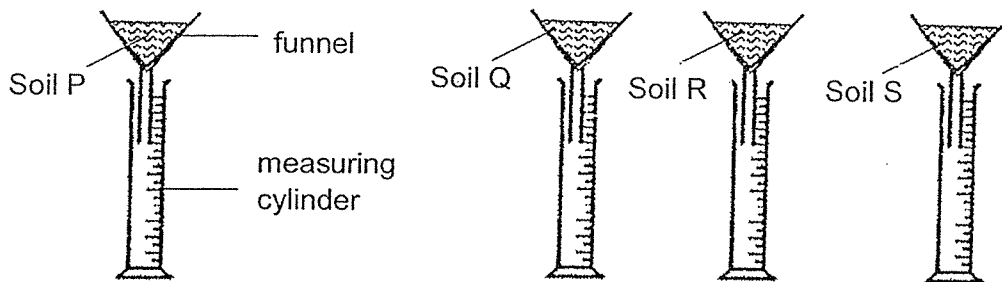

She recorded the volume of water collected in each measuring cylinder after one minute in the table below.

Volume of water in each measuring cylinder for soil (ml)			
P	Q	R	S
70	10	30	50

Lenny wanted to grow a plant whose roots require most amount of water. Which soil should she use?

- (1) P
- (2) Q
- (3) R
- (4) S

13 Study the experimental set-up as shown below.

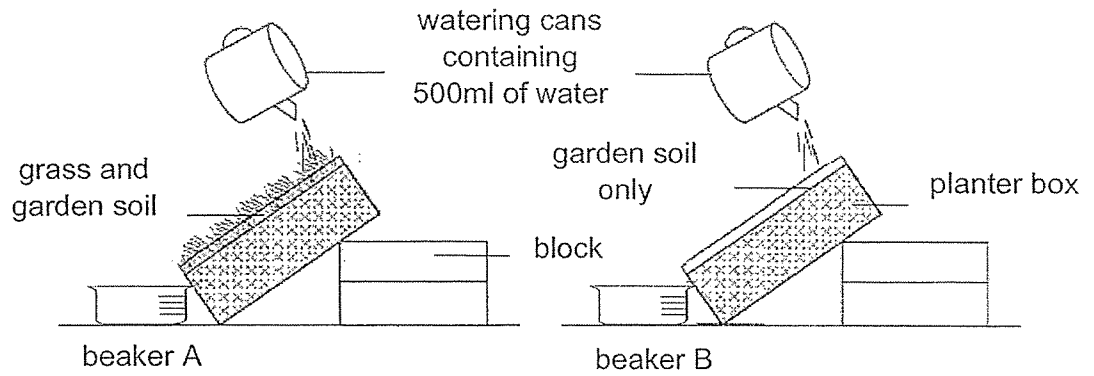

It was observed that there was garden soil in the water collected in beaker B but not in beaker A.

The experiment shows the effect of _____.

- (1) deforestation
- (2) land pollution
- (3) water pollution
- (4) global warming

- 14 The food web below shows the relationships among organisms, A, B, C, D, E and F, living in a community.

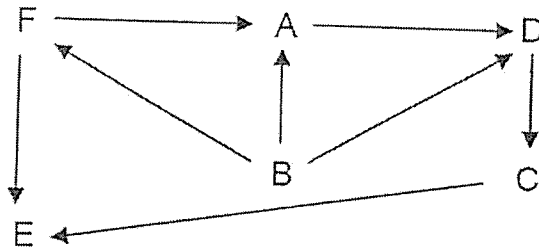

Some of the above organisms were classified as shown in the table below. Which classification is correct?

	Prey only	Both Prey and Predator
(1)	B	A, C, D, F
(2)	B	A, C, D
(3)	F	A, C, D
(4)	F	A, C, E

- 15 Tony wanted to find out how the arrangement of bulbs affects the brightness of the bulbs. Set-ups, X and Y, show the arrangement at the start of the experiment.

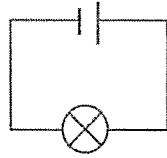

Set-up X

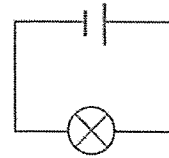

Set-up Y

He then added one more bulb to each of the circuit and observed the brightness. He drew a graph to show the result of his experiment.

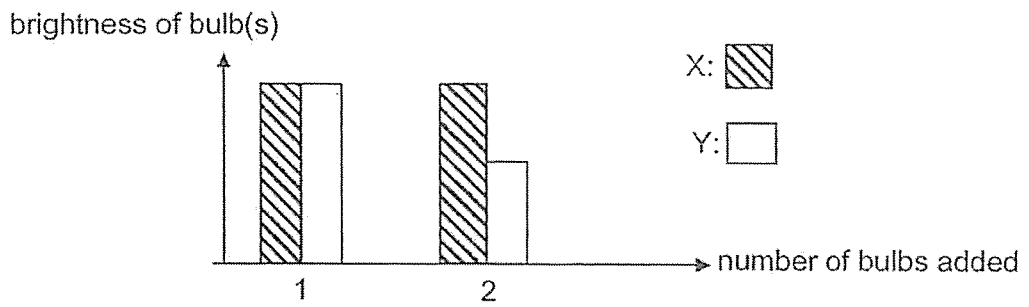

Which of the following is correct about the arrangement of bulbs in the set-ups after one more bulb is added?

	Set-up X	Set-up Y
(1)		
(2)		
(3)		
(4)		

- 16 Ali wants to carry out an experiment to investigate how the exposed surface area of water affects the rate of evaporation. The table below shows the conditions of the set-ups.

Exposed surface area of water (cm ²)	Temperature of water (°C)
25	30
20	25
30	30
35	30
20	15

How many set-ups could be used for his experiment?

- (1) five
 (2) two only
 (3) three only
 (4) four only
- 17 Paul melted a container of ice cubes. The starting temperature of the ice cubes was below 0°C. He measured the temperature of the content in the container over a period of time.

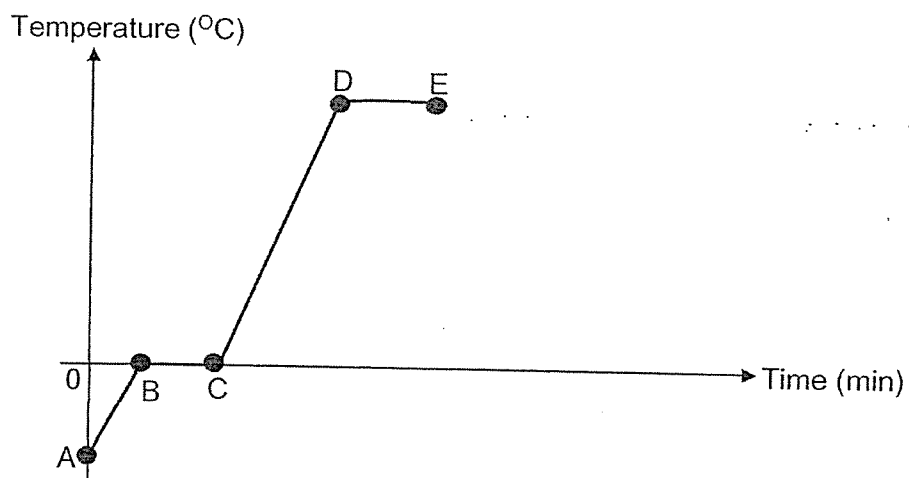

Which of the following statements is **not correct**?

- (1) Ice melted from A to C.
 (2) Evaporation took place from C to D.
 (3) Water gained heat between D and E.
 (4) Water has reached its boiling point at D.

- 18 Chin Wen wanted to compare the time it takes for ice to melt in carbon dioxide and the time it takes for ice to melt in air.

He carried out some steps to prepare two flasks, A and B. Flask A is filled with carbon dioxide and flask B is filled with air.

He placed both flasks on a hot plate for 15 seconds. Then he removed the stopper and dropped the ice cube into each flask, A and B. He measured the time taken for the ice cube to melt completely. The results were recorded in a table below.

Flask	Time taken for ice cube to melt completely (min)
A	1
B	3

What could he deduce from the experiment?

A: Ice needs carbon dioxide to melt. ✗

B: Carbon dioxide is a greenhouse gas. ✓

C: Melting point of ice in flask A is higher than the ice in flask B ✗

(1) A only

(2) B only

(3) A and B only

(4) B and C only

- 19 Which one of the following is not a matter?

(1) air

(2) dust

(3) water

(4) shadow

- 20 The table shows the property of three objects X, Y and Z.

	X	Y	Z
Has mass	Yes	Yes	Yes
Can be seen	Yes	Yes	No
Has a definite shape	No	Yes	No

Which of the following statements is true?

- (1) Y must be a gas.
- (2) Y must be a solid.
- (3) X must be a liquid.
- (4) X and Z must have indefinite volume.

- 21 Two empty containers of identical size were placed in a basin of water at 80°C as shown below. The containers were made of material P and Q.

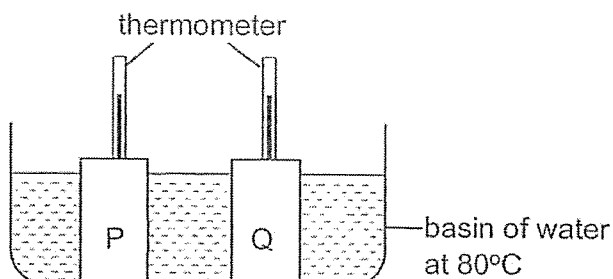

The readings on the thermometers were recorded at a 5-minute interval as shown in the table below.

Time(min)	5	10	15	20	25	30
Thermometer reading in P (°C)	29	35	42	50	57	64
Thermometer reading in Q (°C)	29	30	32	34	36	38

Which material(s) would be more suitable for keeping food hot and drinks cold for a long period of time?

		Material for	
		Hot food	Cold drinks
(1)	P		Q
(2)	Q		P
(3)	P		P
(4)	Q		Q

- 22 Caleb carried out an investigation to find out how the position of an object would affect the length of its shadow. He prepared the set-up as shown below. Position A, B, C, D and E are placed at equal gaps between one another.

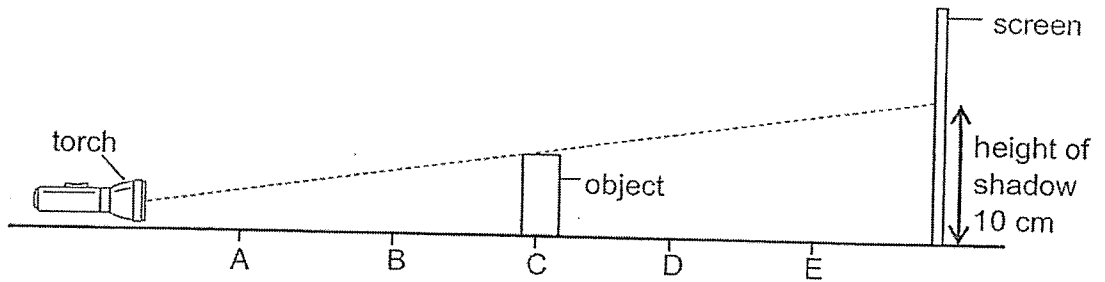

He observed that the object formed a shadow of height 10 cm on the screen when he placed the object at position C. He then changed the position of the object and recorded his findings.

Which set of data is mostly likely to be correct?

	Position of object	Height of shadow (cm)
(1)	A	Less than 10
(2)	B	Same as 10
(3)	D	Less than 10
(4)	E	More than 10

- 23 A mirror is placed at a corner along the classroom corridor to prevent students from colliding into each other when they go around the bend as shown in the diagram below.

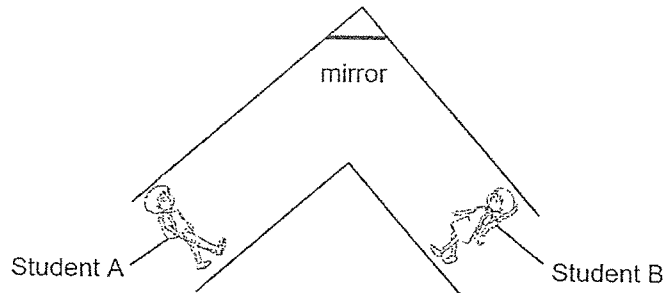

Which property/properties of light help/s to prevent students from colliding into each other when they go around the bend?

- A: Light can be reflected.
B: Light travels in a straight line.
C: Light cannot pass through students.
- (1) B only
(2) A and B only
(3) B and C only
(4) A, B and C
- 24 A ball is released from rest and rolls down a track from the position shown.

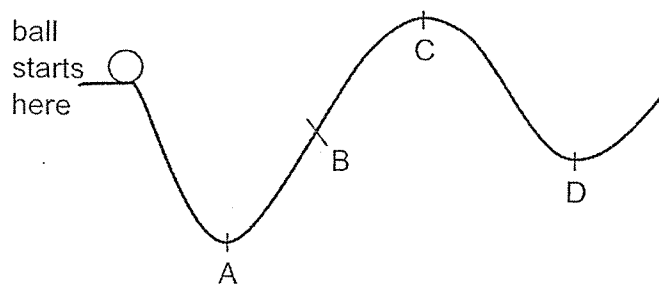

What is the furthest position that is possible for the ball to reach?

- (1) A
(2) B
(3) C
(4) D

25 Daniel arranged three magnets as shown below.

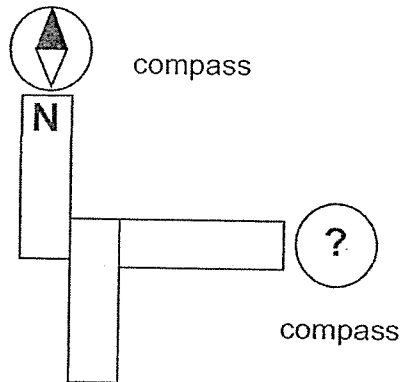

Which diagram shows the correct position of the needle in the compass?

- (1)
- (2)
- (3)
- (4)

26 In which of the set up will the ball be attracted to the electromagnet?

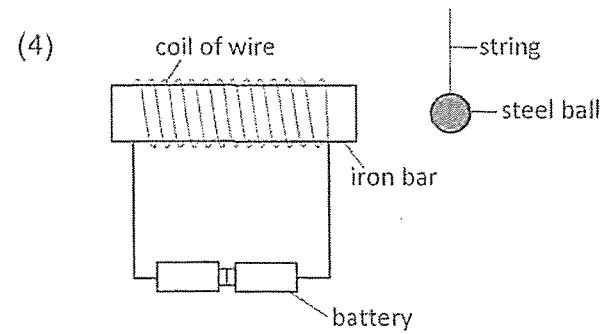
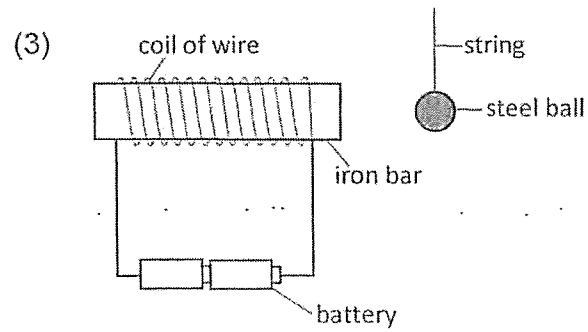
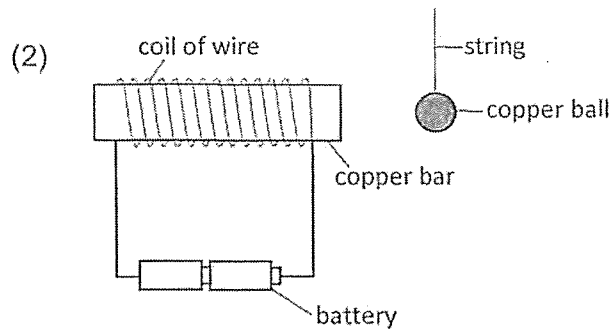
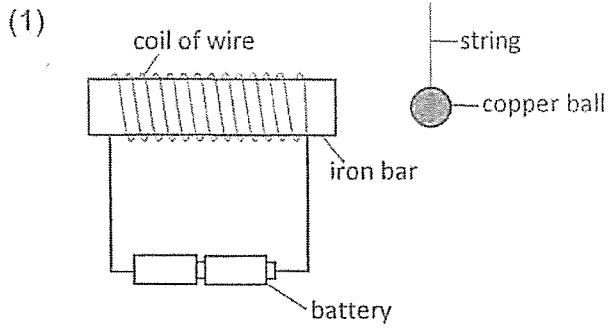

3

- 27 The graph below shows how the length of two springs, P and Q, changed when different mass is added to each spring.

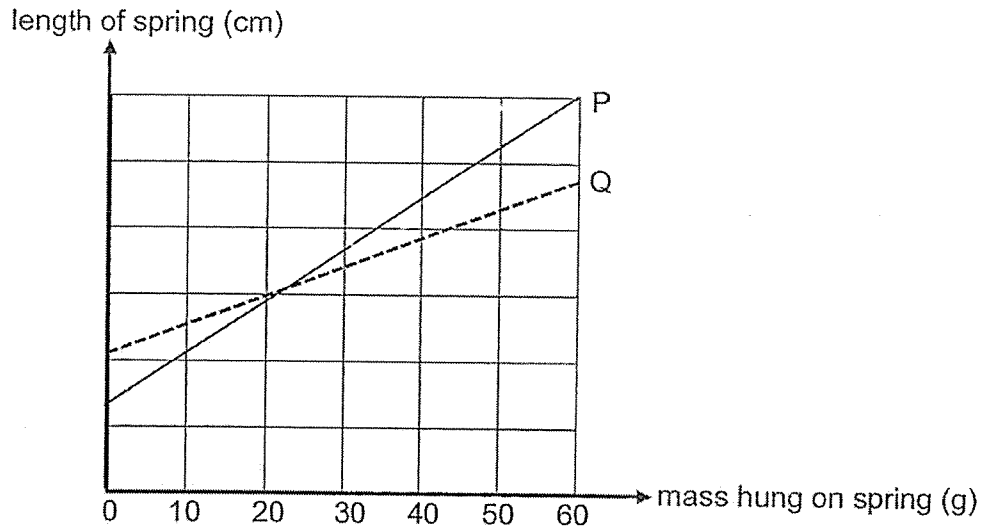

Amirah has a jack-in-the-box as shown below. She wants 'jack' to spring faster with a greater force out of the box.

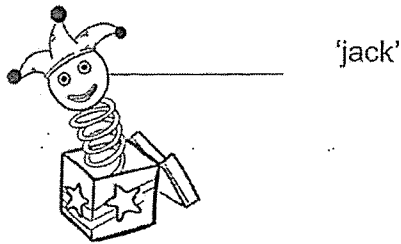

Which spring could she use and why?

	Spring	Reason
(1)	P	P is stiffer than Q
(2)	P	P is less stiff than Q
(3)	Q	Q is stiffer than P
(4)	Q	Q is more elastic than P

28 Two groups of people were in a tug-of-war as shown below.

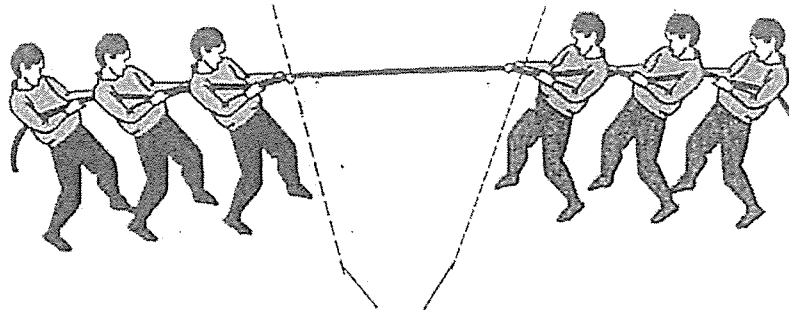

starting lines marked on the floor for each group

Neither of the groups was able to make the other group move to its side because

- _____.
- (1) the force they exerted was not great enough
 - (2) the friction between their feet and the ground prevented it
 - (3) each group exerted an equal and opposite force on the other group
 - (4) the gravitational force was greater than the pulling force exerted by each group

(Go to Booklet B)



Rosyth School
Preliminary Examination 2023

SCIENCE
Primary 6

Name: _____

Total
Marks:

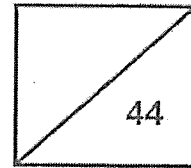

Class: Pr 6 _____

Register No. _____

Date: 24 August 2023

Parent's Signature: _____

Duration: Total time for Booklets A and B: 1 h 45 min

Booklet B

Instructions to Pupils:

1. Please do not turn this page until you are told to do so.
2. Follow all instructions carefully.
3. Answer all questions.
4. Use a dark blue or black ballpoint pen to write your answers in the space provided for each question.
5. Do not use correction fluid/tape or highlighters.

	Maximum	Marks Obtained
Booklet A	56 marks	
Booklet B	44 marks	
Total	100 marks	

* This booklet consists of 19 printed pages (including this cover page).

This paper is not to be reproduced in part or whole without the permission of the Principal.

For questions 29 to 40, write your answers in the space provided.

(44 Marks)

29 A plant was placed in a cylinder of water near a window as shown below.

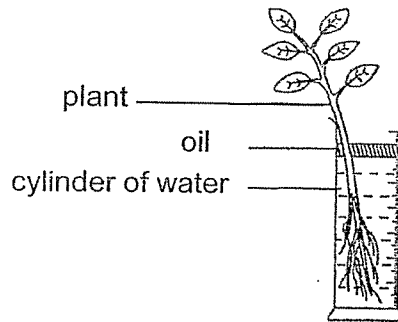

(a) Complete the boxes to show the movement of water in plants. [1]

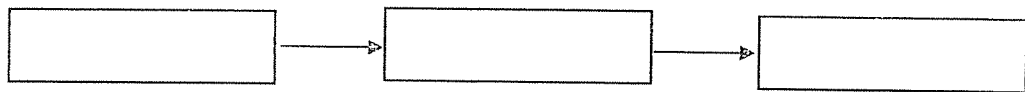

An experiment was carried out using the set-up above over a period of three days to measure the rate of water uptake by the plant. The results are shown below.

Day	Rate of water uptake (ml/h)	
	12pm	12am
One	10	4
Two	16	4
Three	9	4

(b) Name a physical factor in the environment that has caused a difference in the rate of water uptake at 12pm for the three days. [1]

30 The diagram below shows the respiratory system of a fish.

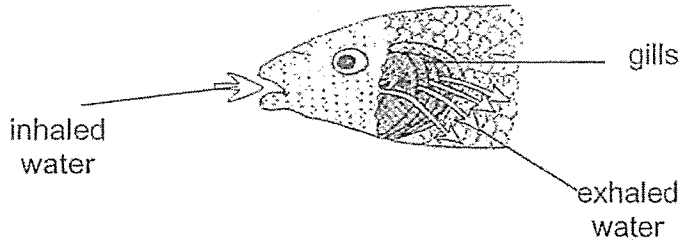

The table compares the amount of carbon dioxide in inhaled and exhaled water.

(a) Complete the table below. Write 'none', 'less' or 'more' in each box. [1]

Gas	inhaled water	exhaled water
Carbon dioxide		

A scientist wanted to find out how the amount of oxygen taken in by a fish is affected when the water was polluted by floor cleaner. She prepared two set-ups as shown below.

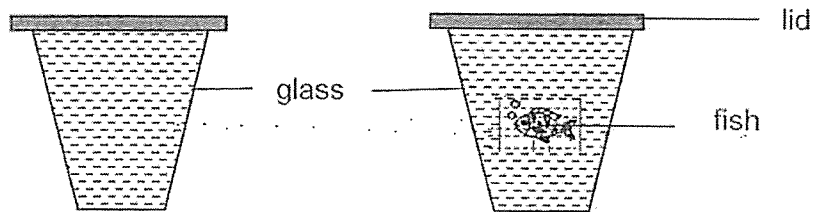

water with floor cleaner only

water with floor cleaner and a fish

She repeated the experiment with different amounts of floor cleaner. The table below shows the amount of oxygen in the water after one hour in both set-ups.

Amount of floor cleaner (units)	Amount of oxygen in water (mg/l)	
	with floor cleaner only	with floor cleaner and a fish
50	1.9	1.7
100	1.4	1.0
150	1.1	0.5

Question 30 continues on page 4

(b) State the relationship between the amount of floor cleaner in the water and the amount of oxygen in the water after one hour. [1]

(c) Explain why the set-up with **floor cleaner only** is needed for the [1]

31 The diagram below shows two flowers of the same type.

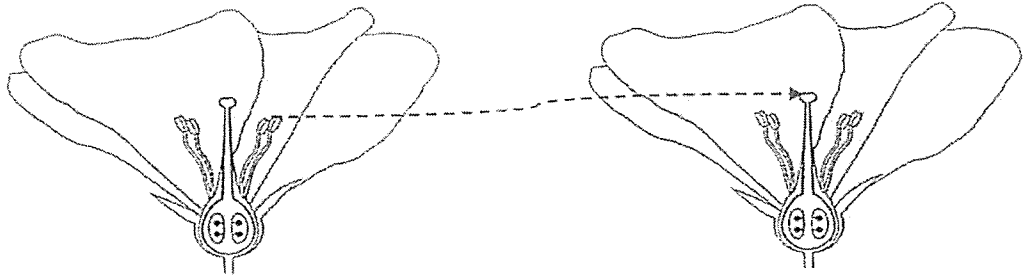

(a) Name the process represented by the arrow.

[1]

(b) Mandy set up an experiment as shown below.

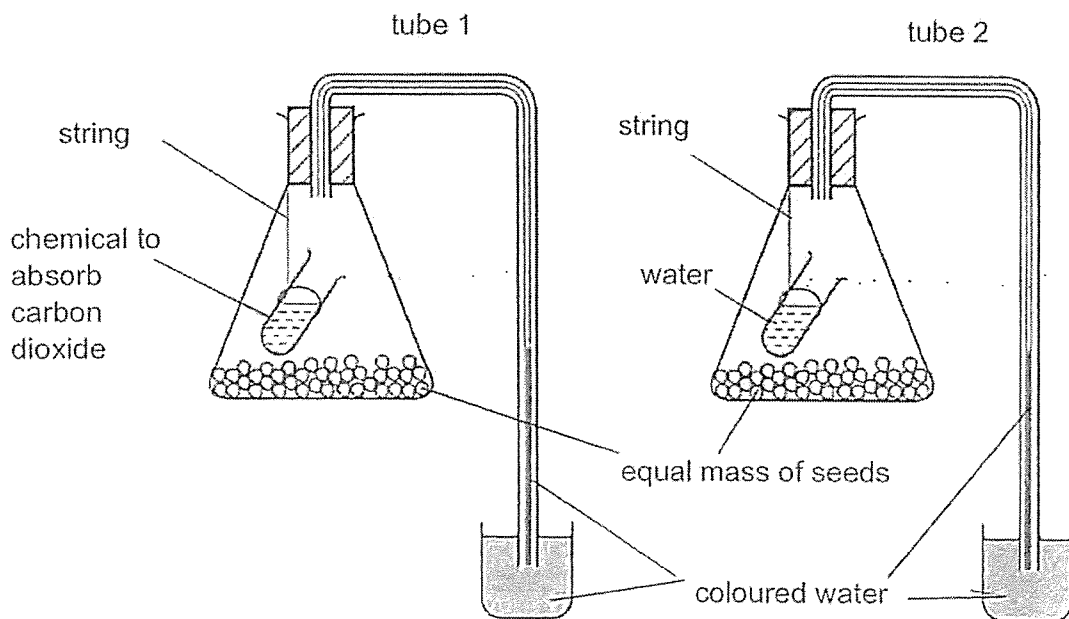

Question 31 continues on page 6

Name two conditions needed for seeds to germinate.

[1]

Condition 1: _____

Condition 2: _____

(c) After four hours, the coloured water in both tubes increased but the coloured water in tube 1 was higher than in tube 2. Explain the observations. [2]

(i) Coloured water in both tubes increased:

(ii) Coloured water in tube 1 was higher than in tube 2:

32 (a) Describe the process of photosynthesis.

[1]

Wei Ling had tube S containing 20g of chloroplasts mixed in blue liquid L. This blue mixture will turn green after photosynthesis has taken place. She placed tube S 10cm from the lamp.

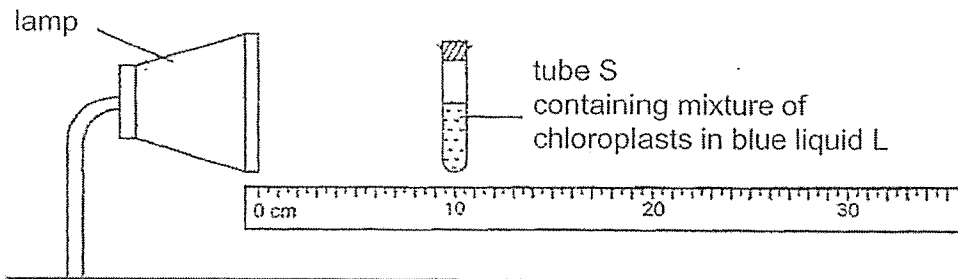

(b) Without changing the lamp, state two methods for the blue mixture in tube S to turn green in a shorter time. Explain why.

[4]

Method 1:

- 33 The rates of water lost in two types of plants, A and B, were measured over a period of seven hours. The results are shown below.

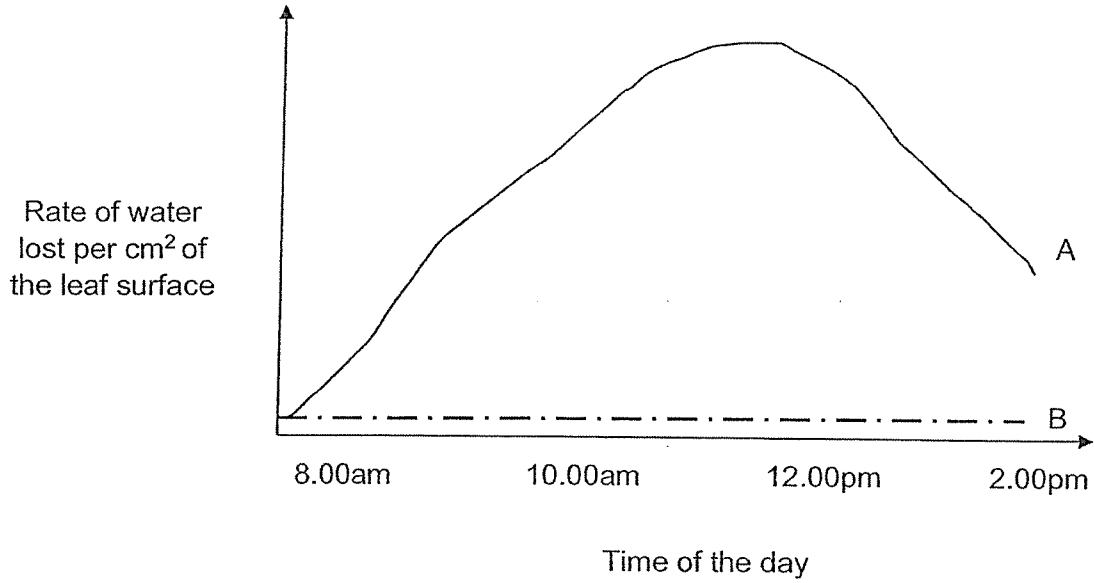

- (a) State two conditions of a desert habitat. [1]

- (b) Which line, A or B, most likely represents a cactus plant? Use the findings and an adaptation of the cactus to explain your answer. [1]

Question 33 continues on page 9

Some students were given three sponges to represent animals in the desert habitat. The students prepared three set-ups to represent the adaptations that will reduce water loss.

These were the steps the students carried out:

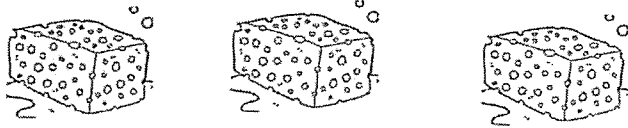
1	Wet the three sponges to the maximum.
	
2	Measure the starting mass of the sponges.
3	Leave the sponges in different conditions, P, Q and R for 24 hours.
4	Measure the final mass of the sponges after 24 hours.

The table below shows the conditions, P, Q and R, and the starting mass of the sponges.

Condition		Starting mass(g)
P	Place the sponge in a shady place.	23
Q	Dig a hole in a tray of sandy soil and place the sponge inside the soil and cover it.	21
R	Put the sponge inside a plastic bag and tie the bag. Place the bag in the open.	20

After obtaining the final mass of the sponges, the students concluded that the sponge in condition Q reduces water loss better than in condition P.

(c) How did they arrive at this conclusion?

[1]

Question 33 continues on page 10

(d) Explain how the animal adaptation in condition Q helped to reduce water loss better.

[1]

(e) Condition R represent a structural adaptation to reduce water loss in the desert. What is the adaptation?

[1]

- 34 Song Yi prepared two similar trays, U and V, with same number of plants with garden soil. She placed the trays next to each other in an open field.

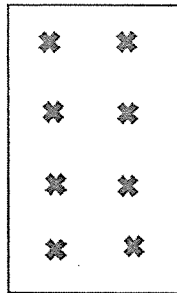

Tray U

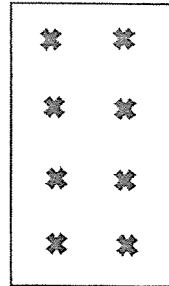

Tray V

 represent a plant

In tray U, all the dead parts of the plants were cut and thrown away as soon as they appeared.

In tray V, the dead parts of the plants were left in the soil.

After some time, it was found that the plants in tray V were growing better than those in tray U.

- (a) What was the most likely reason for the plants to grow better? [1]

- (b) Song Yi wants to show that overcrowding affects plant growth. If she uses similar trays, U and V, what should she do? [1]

- (c) Plants growing in an overcrowding condition, are usually tall and thin. Explain why. [1]

35 The picture below shows an outdoor swing.

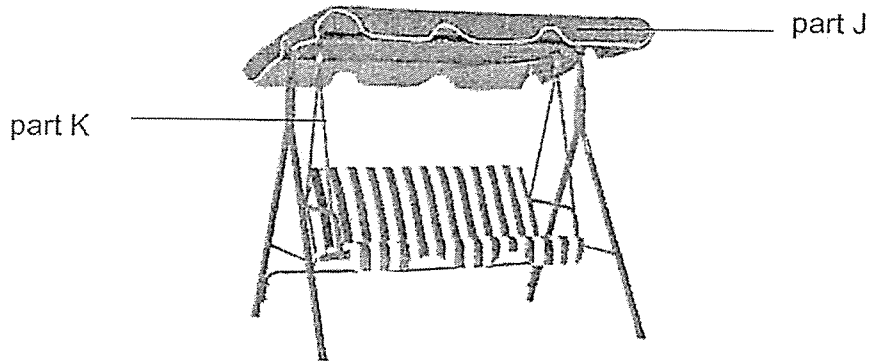

(a) State two properties of the material for part J to keep people on the swing cool. [2]

Property 1: _____

Property 2: _____

(b) An experimental set-up was used to compare four materials, A, B, C and D. For each material, minimum weights needed to break it was measured.

The results are as shown.

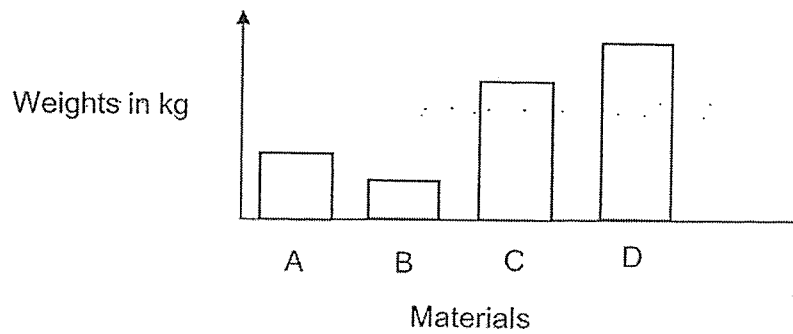

Based on the results, Material _____ is most suitable for part K because

_____ [1]

- 36 Barry carried out an experiment by setting up two circuits as shown in the diagram below. The batteries and bulbs are identical and in working condition.

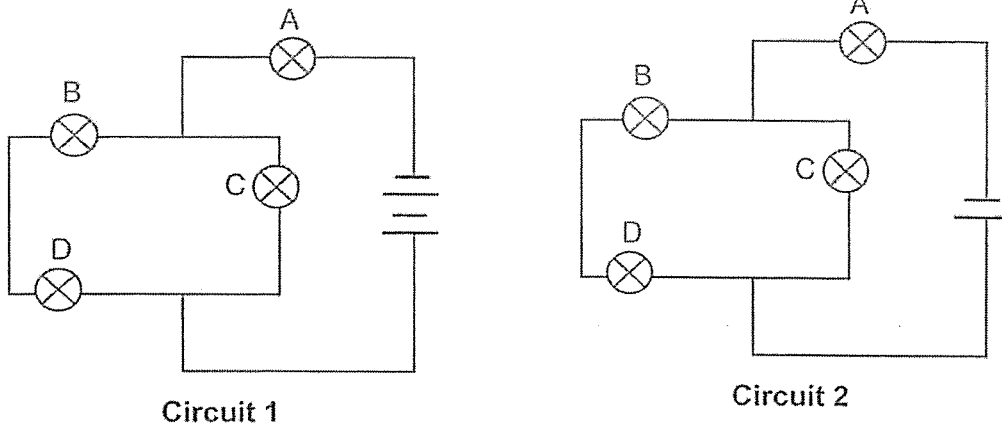

- (a) What is the aim of Barry's experiment? [1]

Barry wanted to add two switches (S1 and S2) to circuit 1.

- (b) Mark and label in the diagram below with two "X" where the switches (S1 and S2) should be placed based on the following conditions. [2]

Switch 1 (S1) - controls all the bulbs

Switch 2 (S2) - only two bulbs will light up when it is open

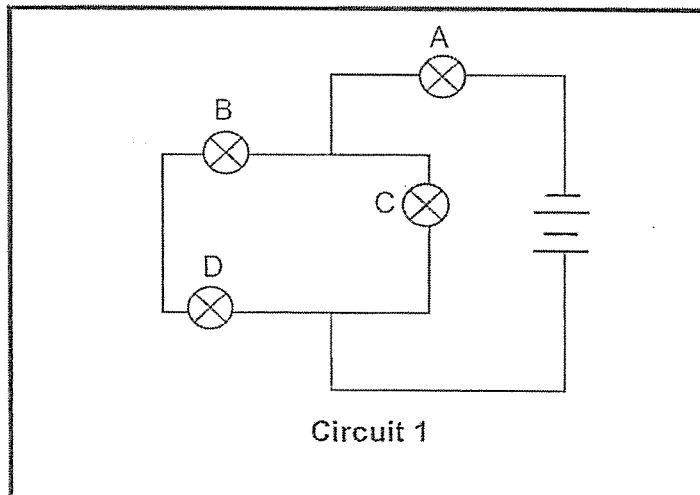

- 37 John set up an experiment as shown below to obtain pure water from seawater. The seawater in the flask was heated up by the Bunsen burner until it boiled. Seawater contains mainly salt and water.

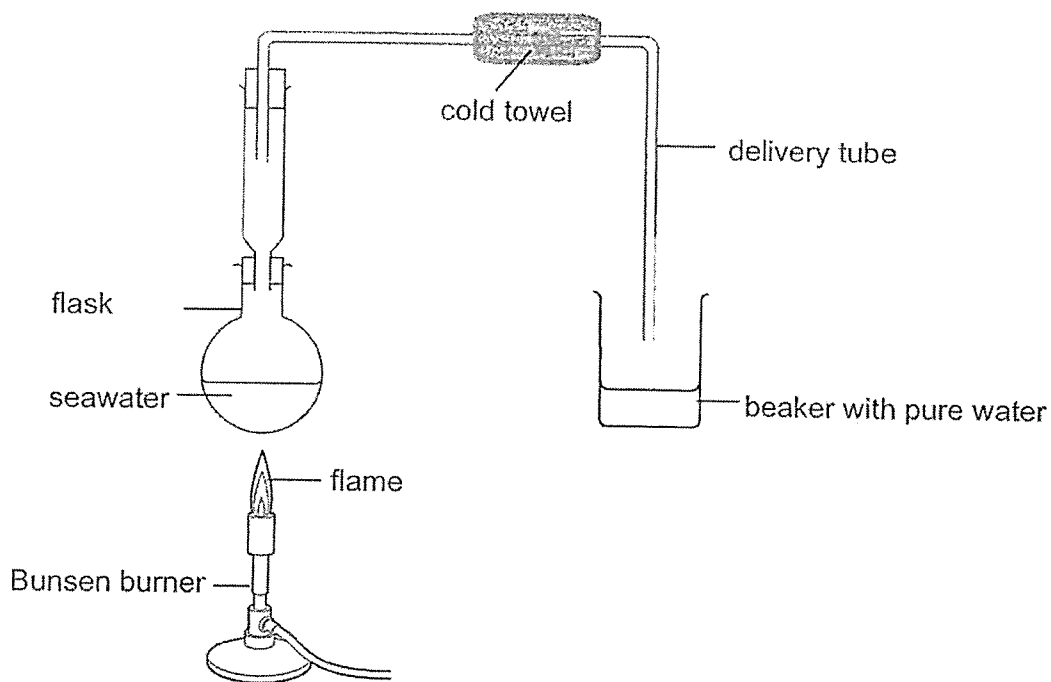

- (a) What is the purpose of the cold towel?

- (b) Suggest one way John could adjust the above set-up so that he could increase the rate of water collection in the beaker.

[1]

- (c) At the end of the experiment, white substances were left in the flask. Give a reason for this observation.

[1]

- 38 Some companies use a conveyor belt system to help transport large cartons between different levels in their factories.

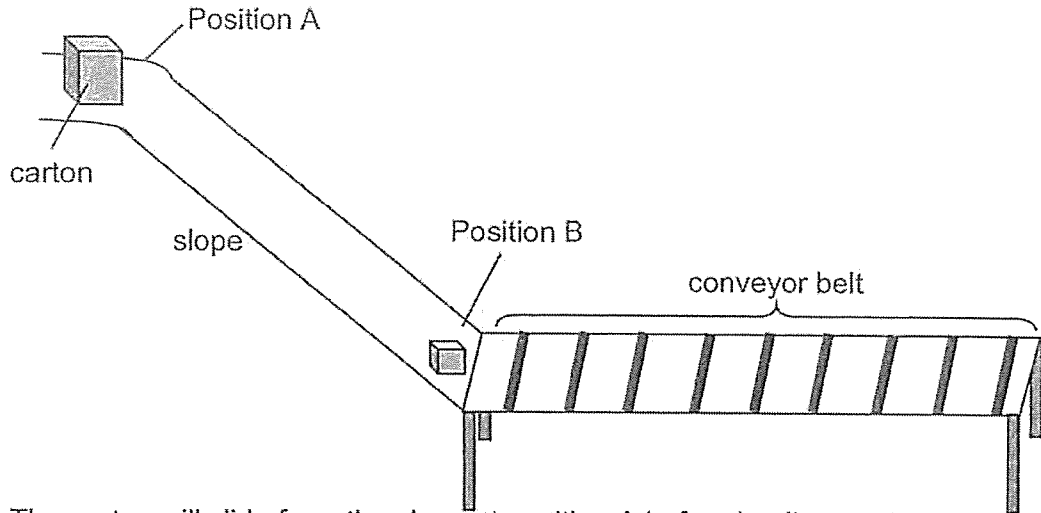

The carton will slide from the slope at position A before landing on the conveyor belt. The conveyor belt will then move to transport the carton to the next location in the factory.

- (a) State the energy conversion that allows the conveyor belt to transport the cartons. [2]

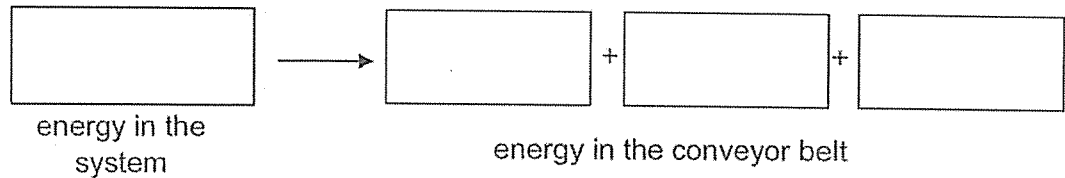

The bar graph below shows the gravitational potential energy of the carton at position A.

- (b) Draw a bar on the graph to show the amount of gravitational potential energy the carton has at B. [1]

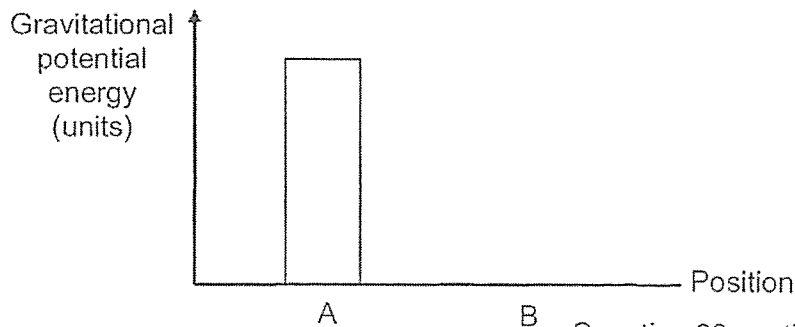

Question 38 continues on page 17

Some small cartons may remain stationary at position B as there is no conveyor belt there. It will remain there until a larger size carton pushes it from behind.

- (c) Explain in terms of energy conversion, how the larger size carton can push the smaller carton in front of it. [2]

- 39 Jonathan placed a piece of paper in between a magnet and a paper clip. The magnet attracted the paper clip as shown below.

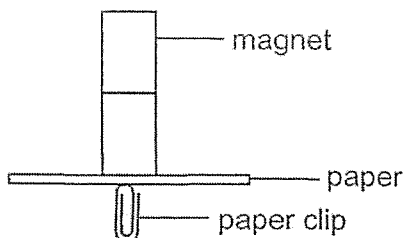

- (a) What property of magnet is shown in the diagram above? [1]

Jonathan predicted that the shorter the magnet, the weaker the magnetic strength. Hence, he investigated using magnets of different lengths. He then added more paper between the magnet and paper clip until the paper clip dropped.

The results were recorded in a table below.

Magnet	P	Q	R
Length of magnet (cm)	10	4	6
Number of papers	13	8	5

- (b) What should Jonathan do to ensure that his results are reliable? [1]

- (c) Do you agree with Jonathan's prediction? Explain. [1]

- 40 Junyi set up an experiment as shown below. He pulled a toy cart up a plank by using a spring. He used the spring balance to measure the force needed to pull the toy cart.

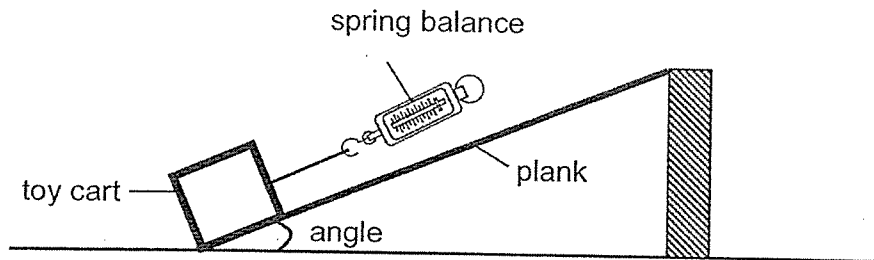

He changed the angle and repeated the experiment. He plotted a graph to show the results of his experiment.

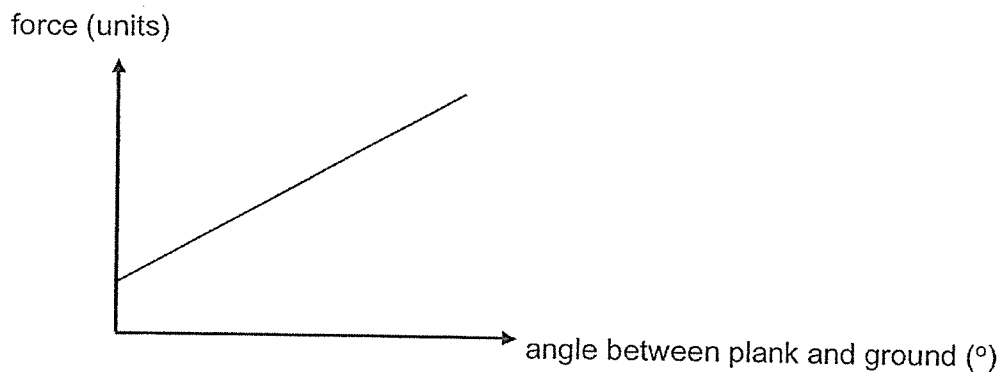

Junyi studied that Animal G lives with areas of mountains and it climbs mountains to eat the grasses there.

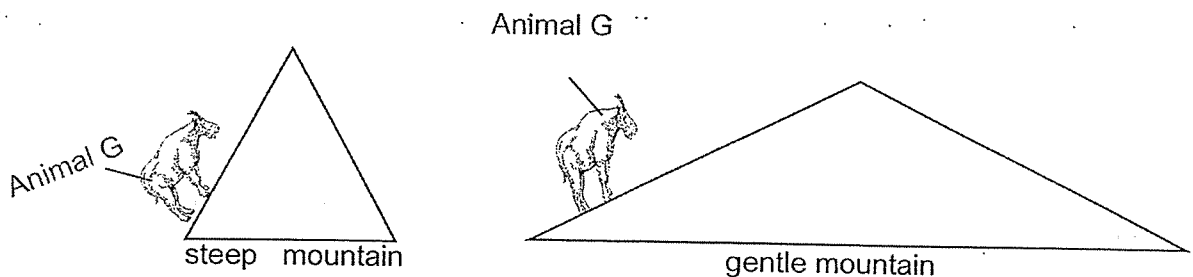

Junyi's hypothesis:

More force is exerted by Animal G when it climbs steeper mountain.

- (a) Do you agree with his hypothesis? Use his findings above to explain your claim. [2]

Question 40 continues on page 19

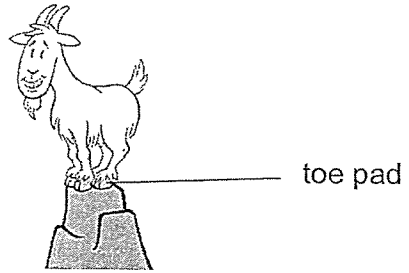

(b) Animal G's toe pads are rough. What is the advantage? [1]

(c) State two benefits for animal G to live up in the mountains. [2]

End of Paper

SCHOOL : ROSYTH PRIMARY SCHOOL
LEVEL : PRIMARY 6
SUBJECT : SCIENCE
TERM : 2023 PRELIMINARY EXAMINATION

SECTION A

Q1	Q2	Q3	Q4	Q5	Q6	Q7	Q8	Q9	Q10
4	1	1	3	2	2	1	3	1	2
Q11	Q12	Q13	Q14	Q15	Q16	Q17	Q18	Q19	Q20
4	2	1	3	4	3	1	2	4	2
Q21	Q22	Q23	Q24	Q25	Q26	Q27	Q28		
4	3	2	2	4	3	3	3		

SECTION B

Q29a	Roots – Stem - Leaves
Q29b	Amount of sunlight
Q30a	Inhaled water: less Exhaled water: more
Q30b	The higher the amount of floor cleaner, the lower the amount of oxygen in the water.
Q30c	To compare and confirm that the amount of oxygen taken in by the fish is affected by the amount of floor cleaner.
Q31a	Pollination
Q31b	Water and oxygen
Q31ci	Oxygen in the flask is used during germination and thus the coloured water rises to take up space in the flask.
Q31cii	Carbon dioxide in the flask is absorbed by the chemical so there is more space for the coloured water to rise.

Q32a)	Chlorophyll traps sunlight to combine with water and carbon dioxide to produce food and oxygen.
Q32b)	<p>Method 1: (Change light) intensity) Move the tubes closer to the lamp</p> <p>Reason: The light intensity is greater so the rate of photosynthesis is faster.</p> <p>Method 2: (Change amount of chloroplast) Increase the number of chloroplasts</p> <p>Reason: More chloroplast can trap more light for faster photosynthesis</p>
Q33a)	Hot and Dry
Q33b)	<p>Claim: B</p> <p>Evidence: The water loss is lower</p> <p>Reason: Cactus have need like leaves and decreases the rate of water loss.</p>
Q33c)	Sponge in Q lose less mass than that of the sponge in P.
Q33d)	The animal in condition Q is hidden away from the outside surrounding air and less evaporation takes place
Q33e)	Waterproof outer covering.
Q34a)	The dead parts are decomposed (broken down into simpler substances) into nutrients for the plant to take in
Q34b)	Plant more plants in U than in V
Q35a)	Opaque and poor conductor of heat
Q35b)	Material D, it withstands the most weight before breaking
Q36a)	To find out how the number of batteries affects the brightness of the bulbs.

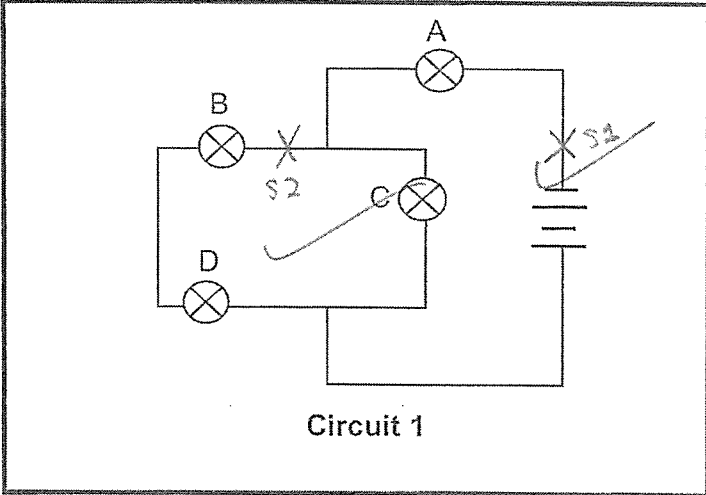
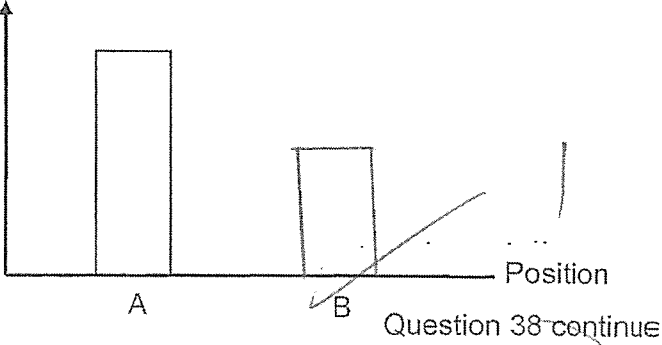
Q36b)	 <p style="text-align: center;">Circuit 1</p>
Q37a)	To cool down the inner part of the tube for water vapour to condense.
Q37b)	Increase the heat from the Bunsen burner
Q38a)	Electrical – kinetic + Heat + Sound
Q38b)	<p>Gravitational potential energy (units)</p>  <p style="text-align: center;">Position</p> <p style="text-align: center;">A B</p> <p style="text-align: right;">Question 38-continue</p>
Q38C)	The large carton has a greater GPE that can be converted to more KE which then converted to more KE to the small carton to move
Q39a)	Magnetism of a magnet can pass through non-magnetic material
Q39b)	Repeat the experiment at least three times and obtain the average result
Q39c)	<p>Claim: No</p> <p>Evidence: Q is the shortest magnet but it can attract through more papers than R</p>
Q40a)	Yes, steeper mountain will have a greater angle of inclination thus more pulling force is needed by Animal G

Q40b)	It can increase the friction between the toe and the ground so it can grip better
Q40c)	Predator will find it difficult to reach animal G. Animal G may not need to compete with other animals for food.