



PEI HWA PRESBYTERIAN PRIMARY SCHOOL
PRELIMINARY EXAMINATION

PRIMARY 6
SCIENCE
(BOOKLET A)

22 AUGUST 2023

Name: _____ ()

Class: Resilience _____

Total time for Booklets A and B: 1 h 45 min

INSTRUCTIONS TO CANDIDATES

1. Write your Name, Class and Register No. in the spaces provided above.
2. DO NOT turn over this page until you are told to do so.
3. Follow all instructions carefully.
4. Answer all questions.
5. Shade your answers on the Optical Answer Sheet (OAS) provided.

This booklet consists of 18 printed pages, excluding the cover page.

For each question from 1 to 28, four options are given. One of them is the correct answer. Make your choice and shade the oval (1, 2, 3 or 4) on the Optical Answer Sheet provided. (56 marks)

- 1 The diagram below shows two organisms, X and Y.

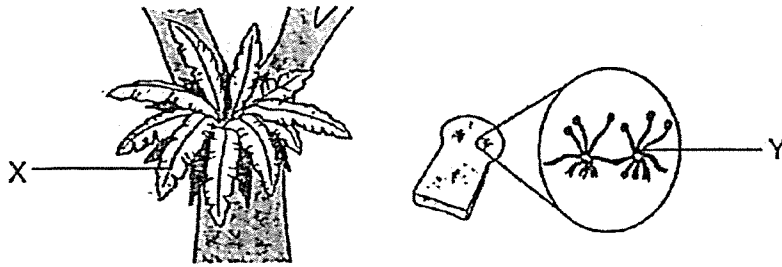

Which of the following statements about X and Y are correct?

- A X is a plant while Y is a fungi.
 - B Both X and Y reproduce from spores.
 - C The seeds of X are dispersed by wind.
 - D Both X and Y obtained food from other organisms.
- (1) A and B only
 (2) B and D only
 (3) A, B and C only
 (4) A, B, C and D

- 2 The flow chart below shows the properties of four different materials, A, B, C and D.

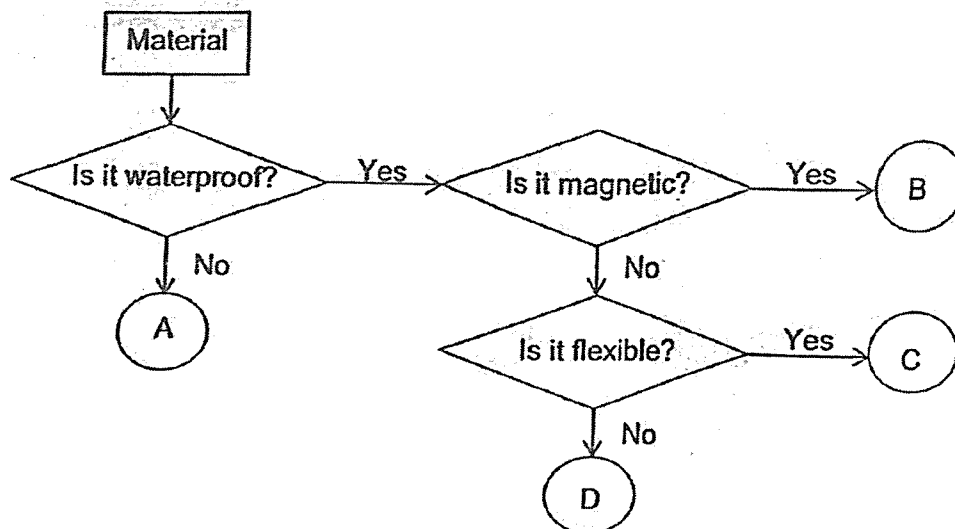

Which of the following statements is true?

- (1) Material A is obtained from plants. x
 - (2) Material C is suitable to make a bath towel.
 - (3) There are 2 similar properties between Materials B and C.
 - (4) There are 2 similar properties between Materials C and D.
- 3 The diagram below shows the human respiratory system.

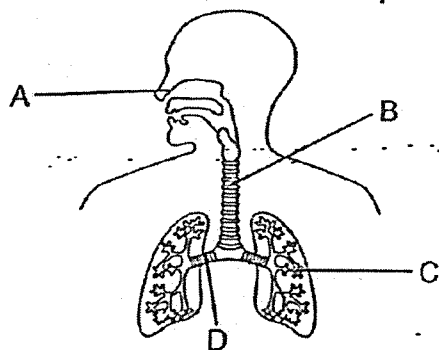

At which part does oxygen enter the circulatory system?

- (1) A
- (2) B
- (3) C
- (4) D

- 4 The diagram below shows the life cycle of two animals, A and B.

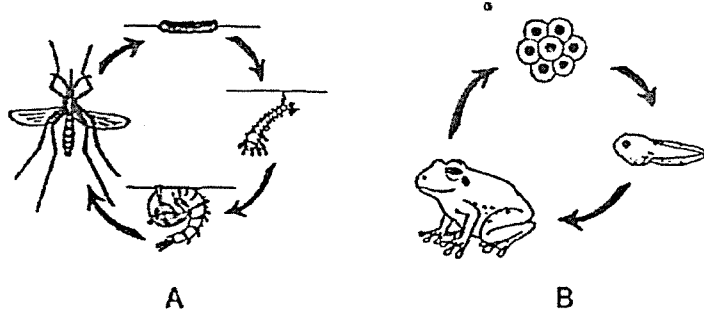

Which of the following statements about A and B are correct?

- A Both A and B reproduce by laying eggs.
- B A and B have different number of stages in their life cycle.
- C Both A and B can live on land and in water at all stages of their life cycle.
- D The young of A breathes through an air tube while the young of B breathes through its skin.

- (1) A and B only
- (2) A and C only
- (3) A, B and D only
- (4) B, C and D only

5 Tim suspended a steel bar, an aluminium bar and two bar magnets from a horizontal rod. The four objects are represented by boxes in the diagram below.

Which one of the following observations is possible?

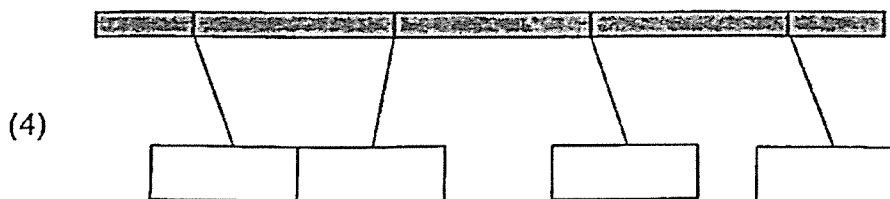
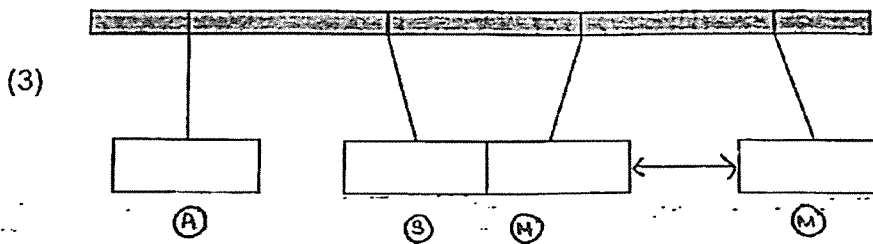
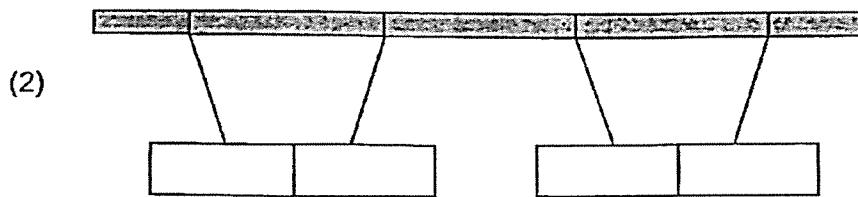
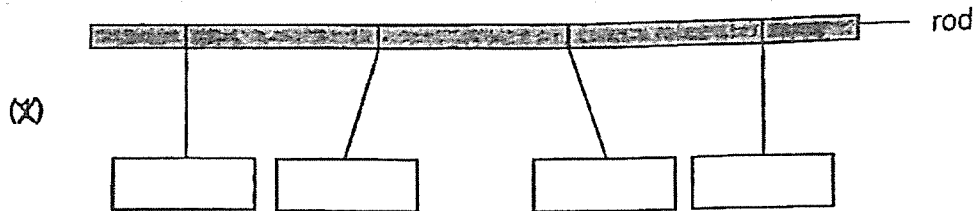

- 6 Tom carried out an experiment using 2 objects, X and Y. He observed the shadow of Y on the screen when the items were placed at the positions as shown below.

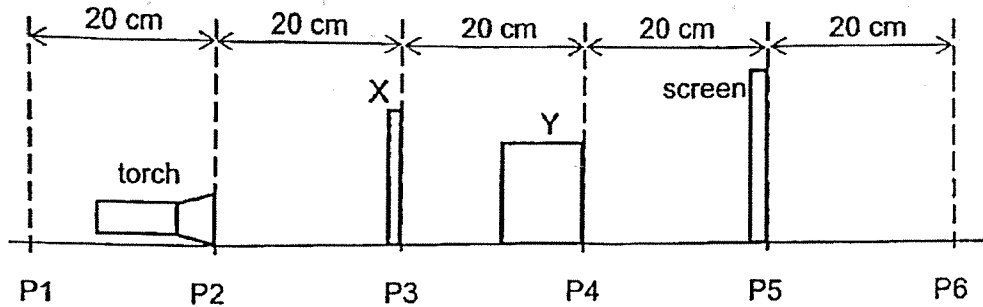

Which of the following correctly shows the position of the items where the shadow of Y on the screen is the biggest?

	Torch	X	Y	Screen
(1)	P1	P2	P3	P4
(2)	P1	P3	P5	P6
(3)	P2	P4	P5	P6
(4)	P2	P4	P3	P5

- 7 The table shows the melting and boiling points of substances A and B.

Substance	A	B
Melting point (°C)	120	50
Boiling point (°C)	450	300

At which temperature are substances A and B in different states of matter?

- (1) 100 °C
- (2) 200 °C
- (3) 280 °C
- (4) 500 °C

8 Which of the following statements about the reproduction of humans are true?

- A A female parent can pass traits to a male child.
- B Heredity is the passing on of characteristics from parents to offspring.
- C The nucleus of both male and female reproductive cells contains genetic information.
- D Fertilisation occurs when the male reproductive cell fused with the female reproductive cell in the ovary.

- (1) A and C only
- (2) B and D only
- (3) A, B and C only
- (4) A, B, C and D

9 P, Q, R and S represent different processes in the change of state in water.

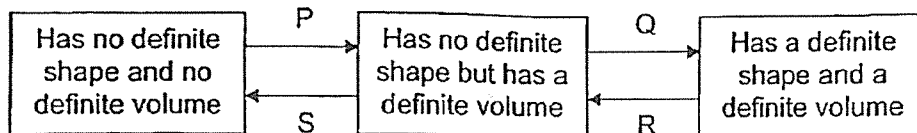

Which of the processes represent freezing and boiling?

	Freezing	Boiling
(1)	P ✗	Q
(2)	R	S
(3)	P	R
(4)	Q ✓	S

10 Which of the following is the basic building block of all organisms?

- (1) cell
- (2) organ
- (3) tissue
- (4) organ system

- 11 The diagram below shows a cross section of the stem of a plant. John wanted to find out if part X transports water to other parts of the plant.

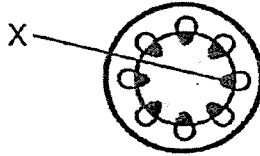

Which of the following should he carry out to confirm the aim of his experiment?

- (1) Perform an iodine test on one leaf of the plant.
 - (2) Measure the volume of water taken in by the roots.
 - (3) Wrap a plastic bag around a leaf and place the plant in the sunlight.
 - (4) Place the plant in coloured water for 10 hours before cutting the stem into 5 equal sections.
- 12 Alvin set up the circuit as shown below.

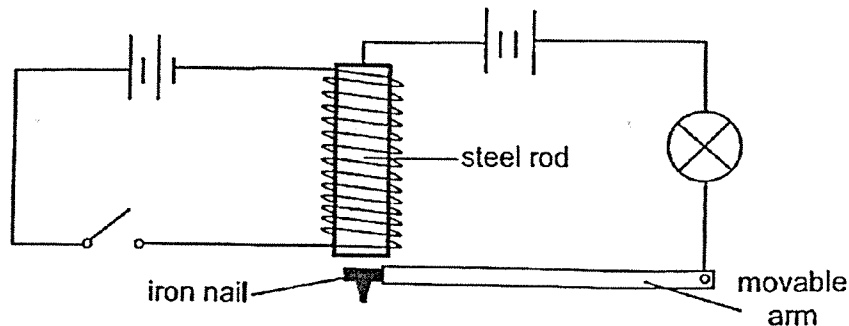

Which of the following statements is true when the switch is closed?

- (1) The iron nail does not move and the bulb does not light up.
- (2) The iron nail is attracted to the steel rod and the bulb lights up.
- (3) The steel rod heats up and the iron nail is repelled by the steel rod.
- (4) The iron nail is attracted to the steel rod but the bulb does not light up.

- 13 The diagram below shows a solar-powered toy which can turn round and round when placed in a bright location.

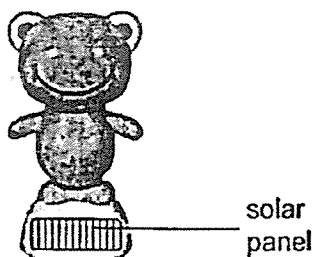

What is the energy conversion that takes place when light is shone onto the toy?

- (1) heat energy → potential energy → light energy
- (2) light energy → electrical energy → kinetic energy
- (3) electrical energy → potential energy → kinetic energy
- (4) potential energy → electrical energy → light energy

- 14 Sean set up an experiment as shown in the diagram below. He wanted to find out how the amount of potential energy stored in the toy car affects the distance travelled by the car.

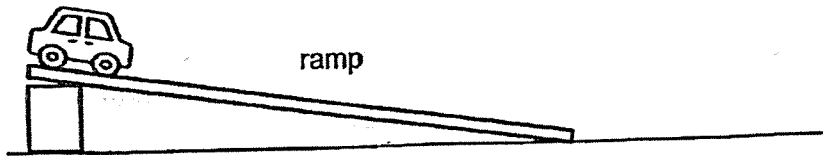

Which one of the following correctly shows the variables to be changed, kept the same and measured?

(1)

Variable	Changed	Kept the same	Measured
Type of ramp		✓	
Mass of toy car		✓	
Height of ramp			✓
Distance travelled by toy car	✓		

(2)

Variable	Changed	Kept the same	Measured
Type of ramp	✓		
Mass of toy car		✓	
Height of ramp	✓		
Distance travelled by toy car			✓

(3)

Variable	Changed	Kept the same	Measured
Type of ramp		✓	
Mass of toy car		✓	
Height of ramp	✓		
Distance travelled by toy car			✓

(4)

Variable	Changed	Kept the same	Measured
Type of ramp	✓		
Mass of toy car		✓	
Height of ramp		✓	
Distance travelled by toy car			✓

- 15 Two objects of different masses were released from the same height 8 m. Which of the following graphs correctly shows the relationship between the amount of kinetic energy the objects have and the distance travelled by the objects?

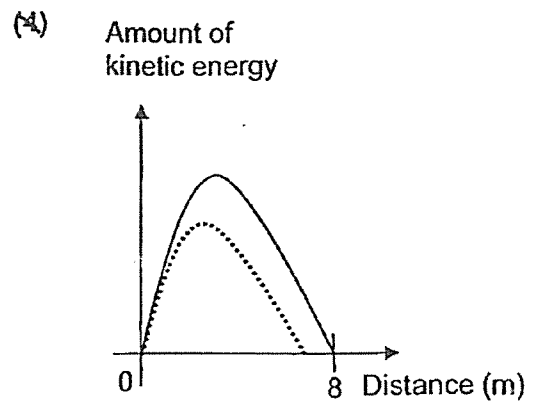
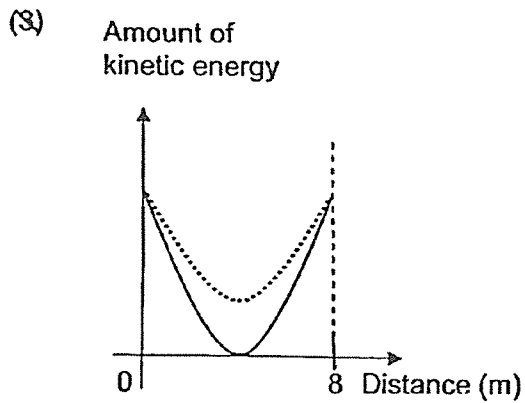
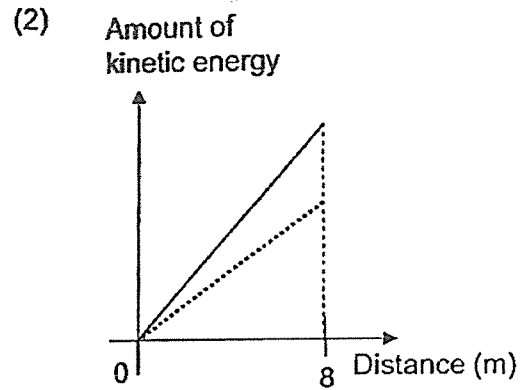
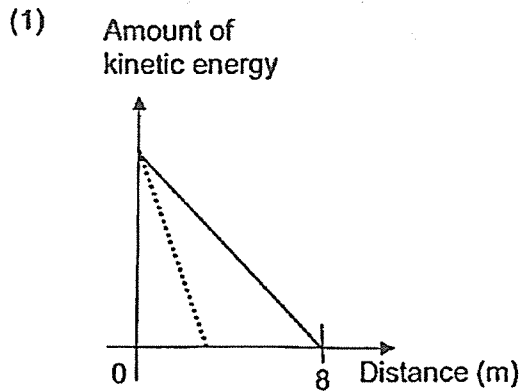

- 16 Dan placed 4 plants in similar containers, A, B, C and D with the same amount of water as shown in the diagram below. He left the set-ups near the window and recorded the height between the lid and the layer of oil for each set-up after 4 hours.

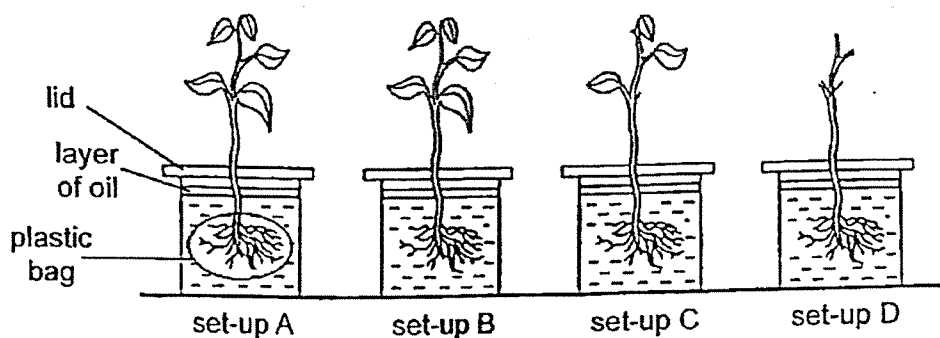

Which of the following correctly shows the height between the lid and the layer of oil from the greatest to the smallest?

- (1) A, D, C, B
 (2) B, A, C, D
 (3) B, C, D, A
 (4) D, C, A, B
- 17 Which of the following do plants need to carry out photosynthesis?

- A chlorophyll
 B flowers
 C water-carrying tubes
 D tiny openings on leaves

- (1) A and B only
 (2) A, C and D only
 (3) B, C and D only
 (4) A, B, C and D

- 18 Alan removed an outer ring of the stem from a plant as shown below. Part X stores food for the plant.

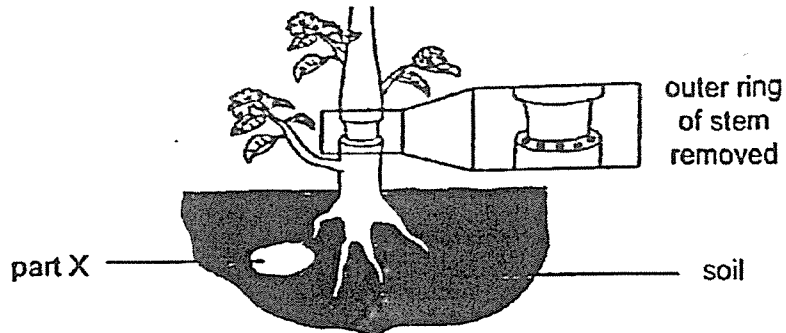

After 2 weeks, he observed that part X became smaller although the plant remained healthy. Which of the following statements explain his observation?

- A The plant can no longer photosynthesize.
- B Some food stored in part X was used by the roots.
- C Food made in the leaves could not be transported to part X.
- D Food-carrying tubes in the stem had been removed together with the outer ring.

- (1) B and D only
- (2) A and C only
- (3) B, C and D only
- (4) A, C and D only

19 Caden hung 4 different masses, A, B, C and D using similar springs as shown below.

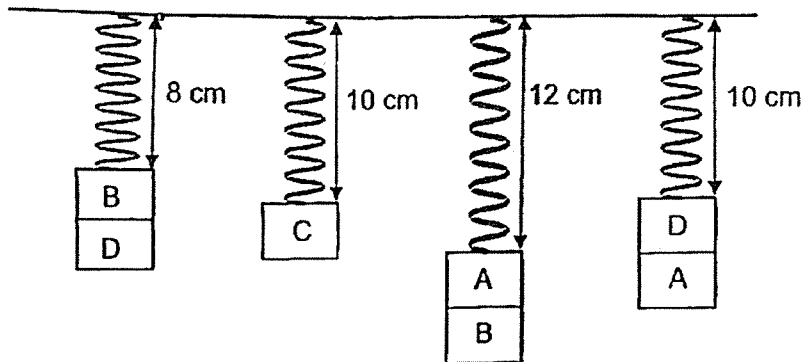

Which of the following statements shows the correct arrangement of the masses from the smallest to the largest?

- (1) B, C, A, D
- (2) B, D, A, C
- (3) C, A, B, D
- (4) D, B, A, C

20 Ginny placed a wooden block on a table with a magnet attached at the bottom. She gave the block a push and observed that the block moved along the table as shown in the diagram below.

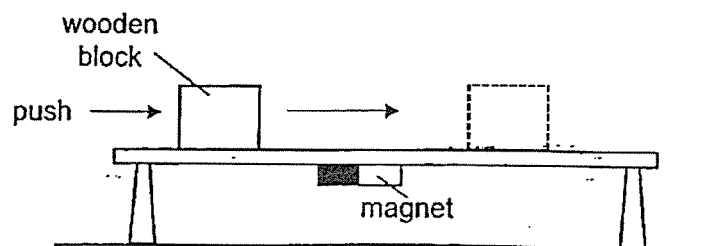

Which of the following correctly shows the forces acting on the block when it was moving?

	Gravitational force	Magnetic force	Frictional force
(1)	✓	✓	
(2)	✓		✓
(3)		✓	✓
(4)	✓	✓	✓

- 21 The diagram below shows two similar metal balls, P and Q moving at the same speed, in opposite direction.



Which of the following will happen after P and Q hit each other?

- A P and Q will slow down.
- B P will slow down but Q will move faster.
- C P and Q will move in the same direction.
- D P and Q will move in different directions.

- (1) A and C only
 - (2) B and C only
 - (3) A and D only
 - (4) B and D only
- 22 Andy wanted to find out if overcrowding affects the growth of a plant. Which three set-ups should he use for his experiment?

Set-up	Number of plant	Type of soil	Size of pot
A	3	clayey	small
B	3	garden	big
C	5	garden	small
D	5	garden	big
E	5	clayey	small
F	10	garden	big

- (1) A, C and E
- (2) C, D and E
- (3) A, B and F
- (4) B, D and F

- 23 The food relationship between three organisms is shown below.

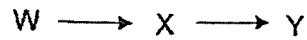

The following events took place when a large number of organism Y died.

- A There was insufficient food for X.
- B The number of organism X increase.
- C The number of organism X decrease.
- D The number of organism W decrease.

Which of the following shows the correct sequence of events?

- (1) A, C, D, B
 - (2) B, C, D, A
 - (3) B, D, A, C
 - (4) C, A, D, B
- 24 Insect X lays many eggs on the leaves of plant Y. When the eggs hatched, the larvae will feed on the leaves of plant Y which are poisonous to other organisms.

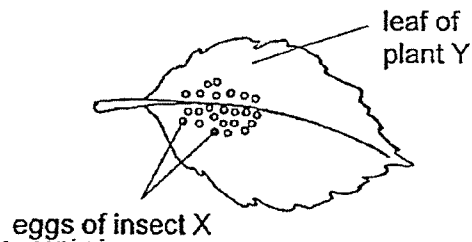

Which of the following is a possible reason for insect X to lay eggs on the leaves of plant Y?

- (1) To help the eggs blend into the surroundings.
- (2) To reduce the population of poisonous plant Y.
- (3) To reduce the chances of predators eating the larvae.
- (4) To reduce overcrowding when the eggs are hatched.

25 Study the food web below.

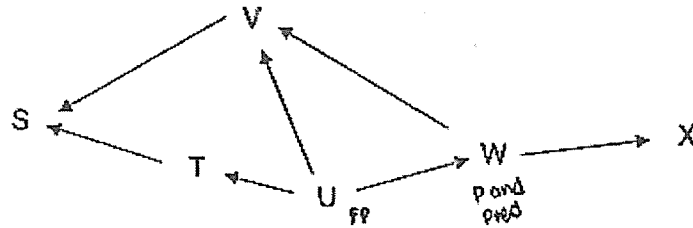

Which statement(s) is/ are correct?

- A U is a producer.
- B W is a prey and a predator.
- C S is a plant-and-animal eater.
- D All the energy in the food web is transferred to X.

- (1) A only
- (2) A and B only
- (3) B and C only
- (4) A, C and D only

26 The table below shows the characteristics of plants E, F, G and H.

Plant	Characteristics
E	needle-like leaves
F	waxy leaves
G	fleshy stem
H	stalk with air-filled spaces

Which of the following correctly matches the plant to the environment in which they are found?

	Habitat	Plant
(1)	Desert	E and H
(2)	Desert	E, G and H
(3)	Aquatic	F and G
(4)	Aquatic	F and H

- 27 Polar bears live in the northern coastal region in the Arctic. In the recent years, more polar bears have been found going into the human communities further south. Which of the following could be the possible reasons for the polar bears to move further south?
- A The sea ice in the Arctic is not forming.
 - B The polar bears are looking for other food sources.
 - C The temperature in the human communities is lower.
 - D The air is more polluted in the human communities than in Arctic.
- (1) A and B only
(2) A and D only
(3) B, C and D only
(4) A, B, C and D only

28 The diagram below shows the map of Country S.

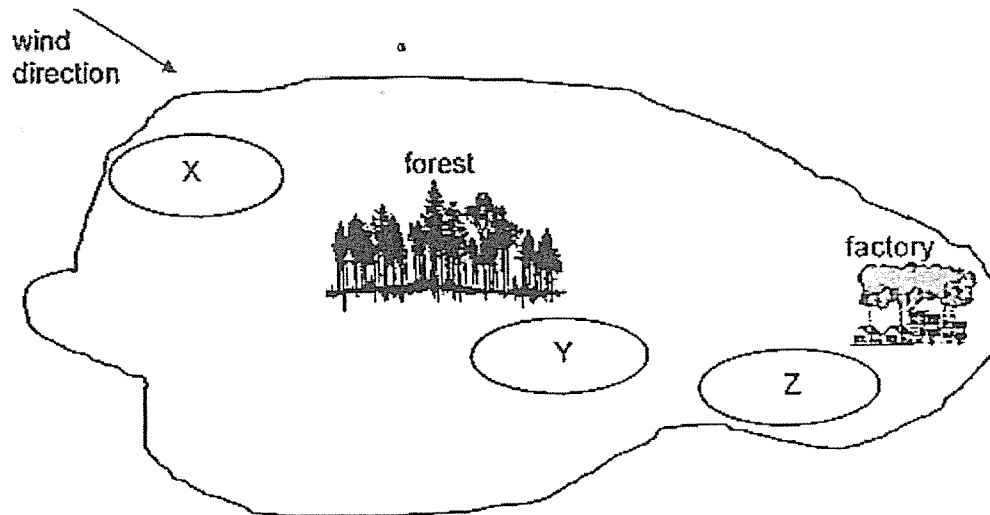

The table below shows the average monthly PSI (Pollutant Standard Index) readings of Country S at locations X, Y and Z. A PSI reading of 150 and above indicates that the air quality is unhealthy.

Average Monthly PSI Readings			
Month	X	Y	Z
May	80	90	140
June	82	220	180

What is/are the possible reason(s) that could have resulted in the change in PSI levels in June?

- A The factory is releasing smoke.
- B Burning of forests to clear land for immediate use.
- C Rising sea level due to the rapid melting of ice caps.

- (1) B only
- (2) A and B only
- (3) A and C only
- (4) A, B and C



PEI HWA PRESBYTERIAN PRIMARY SCHOOL
PRELIMINARY EXAMINATION

PRIMARY 6
SCIENCE
(BOOKLET B)

22 AUGUST 2023

Name: _____ ()

Class: Resilience _____

Parent's Signature

Total time for Booklets A and B: 1 h 45 min

INSTRUCTIONS TO CANDIDATES

1. Write your Name, Class and Register No. in the spaces provided above.
2. DO NOT turn over this page until you are told to do so.
3. Follow all instructions carefully.
4. Answer all questions.
5. Write all your answers in this booklet.

Marks (Booklet A) :	56
Marks (Booklet B) :	44
Total Marks (Booklets A & B) :	100

This booklet consists of 15 printed pages, excluding the cover page.

Write your answers to the questions 29 to 41 in the spaces provided.
 The number of marks available is shown in brackets [] at the end of each question or part question. (44 marks)

- 29 Gary placed material A on a beaker as shown in the diagram below. He poured 100 ml of water onto the material slowly and recorded the amount of water collected in the beaker.

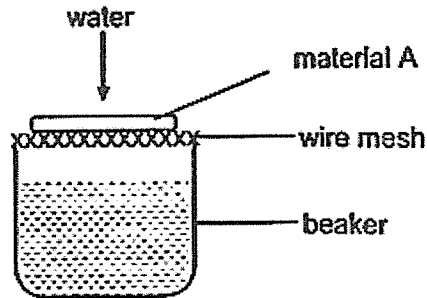

He repeated the experiment using materials B, C and D, and the following table shows the results.

Material	Amount of water collected (ml)
A	80
B	100
C	10
D	45

- (a) Arrange the materials according to how well they absorb water. [1]

most amount of water absorbed	—————→	least amount of water absorbed

- (b) Gary concluded that material B is most suitable for making part U of an umbrella.



Do you think Gary's conclusion is correct? Explain why. [1]

PLEASE DO NOT WRITE IN THIS MARGIN (Go on to next page)

30 The diagram below shows the systems in the human body working together.

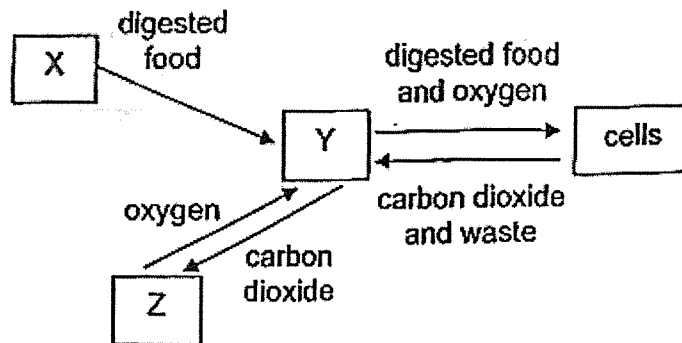

(a) Name systems X, Y and Z.

[1]

X: _____

Y: _____

Z: _____

(b) Explain how the systems work together to provide the cells in the body with digested food. [1]

PLEASE DO NOT WRITE IN THIS MARGIN (Go on to next page)

- 31 Tim found some animal W hidden in a pile of moist dead leaves under a tree. He wanted to find out the suitable living conditions of animal W. He divided a box of soil into 4 parts with different conditions as shown in the diagram below.

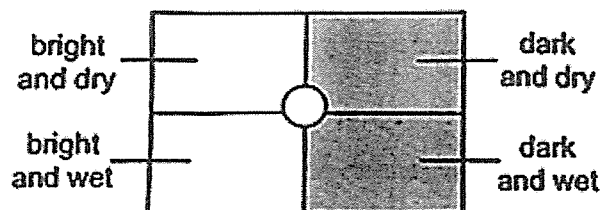

He placed some animal W in the middle of the box and recorded the number of animal W in each part after 1 hour.

- (a) State a hypothesis on the suitable living conditions of animal W. [1]

- (b) Suggest what Tim should observe to confirm the suitable living conditions of animal W at the end of the experiment. [1]

- (c) Why is it important for Tim to count the number of animal W only after 1 hour? [1]

PLEASE DO NOT WRITE IN THIS MARGIN (Go on to next page)

- 32 Ali set up an experiment in a dark room using three different metal frames placed at positions X, Y and Z as shown in the diagram below.

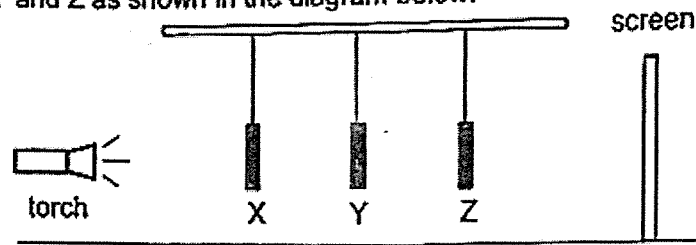

The shapes and sizes of the frames are as shown.

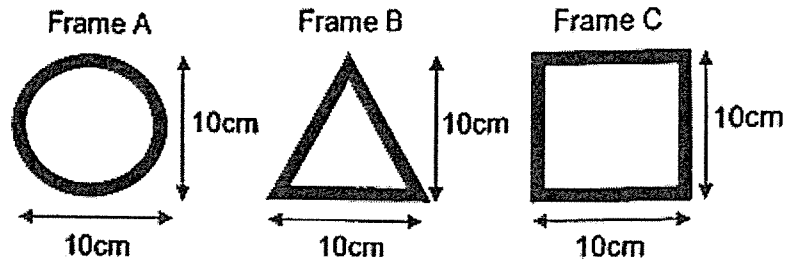

When the torch was switched on, shadows were formed on the screen as shown below.

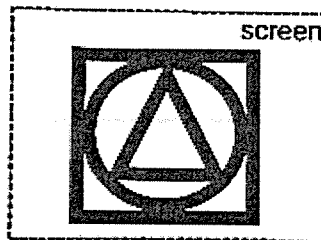

- (a) Based on the shadows cast on the screen, complete the table below to show the correct positions of the frames. [1]

Frame	Position
A	
B	
C	

- (b) Give a reason why Ali conducted the experiment in a dark room. [1]

- (c) State the property of light which allows a shadow to be formed. [1]

PLEASE DO NOT WRITE IN THIS MARGIN (Go on to next page)

- 33 Jack placed two strips J and K which are made of different materials into a container of water. He put some wax at the end of each strip as shown in the diagram below. He heated the container and recorded the time taken for the wax to melt completely.

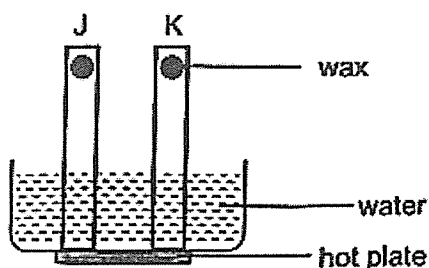

- (a) What should he observe to conclude the aim of his experiment? [1]

- (b) Name one variable he should keep the same and explain how keeping it the same ensures that the experiment was fair. [2]

- (c) Jack noticed that water droplets formed on K in the first few minutes of the experiment but not on J. Explain why water droplets formed on K and not on J during the first few minutes of the experiment. [2]

PLEASE DO NOT WRITE IN THIS MARGIN (Go on to next page)

34 The diagram below shows the cross-section of a flower.

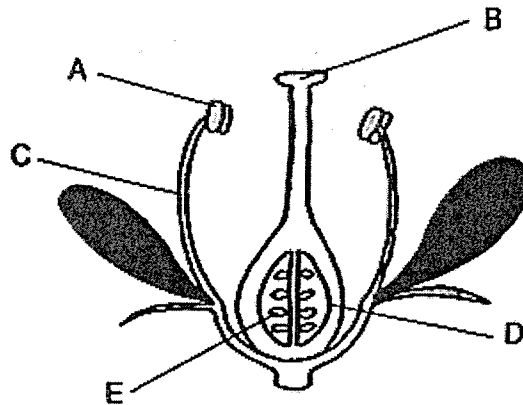

(a) Complete the table with the name of the parts of the flower. [2]

Part	Name
A	
B	
C	
D	

(b) What will happen to part E after fertilisation has taken place? [1]

PLEASE DO NOT WRITE IN THIS MARGIN (Go on to next page)

- 35 Sally set up a circuit as shown below.

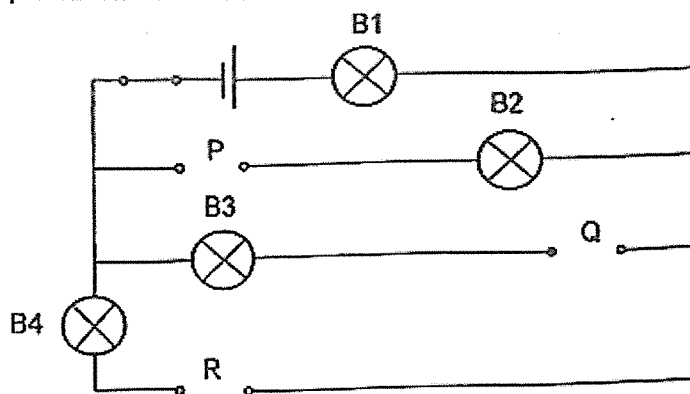

She placed 3 rods X, Y and Z of different materials in positions P, Q and R respectively and recorded the results in the table below.

Position of rod			Did the bulb light up?			
P	Q	R	B1	B2	B3	B4
X	Y	Z	Yes	No	Yes	No

- (a) Based on the results, she wrote the following statements. Put a tick (✓) to show if each statement is true, false or not possible to tell in the table below. [2]

Statement	True	False	Not possible to tell
Y is made of copper.			
B1 is brighter than B3.			
If B4 is removed, B2 will light up.			
X and Z are electrical insulators.			

- (b) State one advantage of connecting bulbs in parallel. [1]

- (c) State one advantage of connecting a switch to an electrical circuit. [1]

PLEASE DO NOT WRITE IN THIS MARGIN (Go on to next page)

36 Sharon carried out an experiment as shown below.

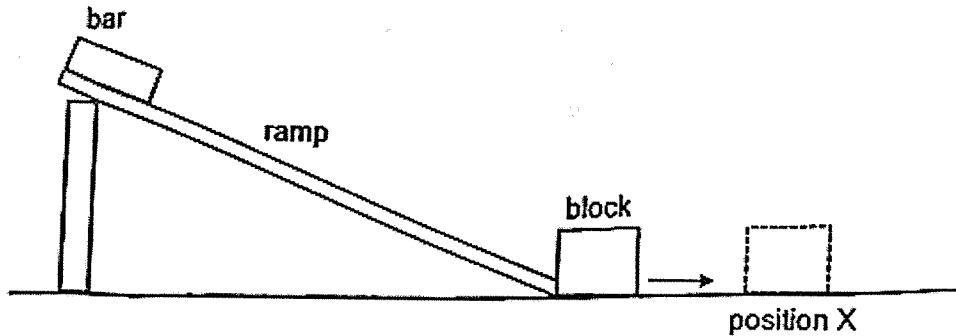

When she released the bar, it moved down the ramp and hit the block. The block then moved along the floor before stopping at position X.

(a) Fill in the blanks to show the main energy conversion in the set-up above. [1]

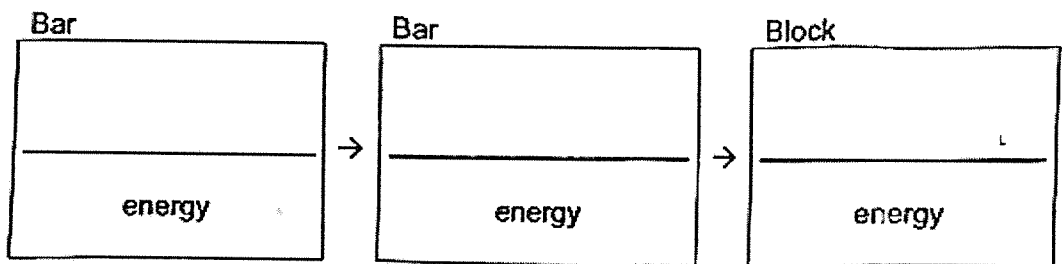

(b) Sharon then applied some oil on the ramp and repeated the experiment. Will the block move a shorter, longer or the same distance along the floor? Explain your answer in terms of energy changes. [2]

(Go on to next page)

37 Sean set up 4 sealed test tubes, A, B, C and D as shown in the diagram below. He filled each set-up with liquid X, which will change from red to yellow when there is an increase in the amount of carbon dioxide. The set-ups were placed near the window.

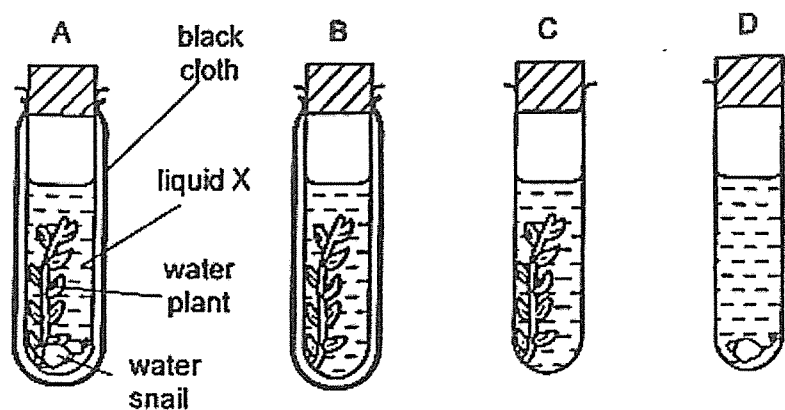

(a) In which set-up(s) would liquid X change from red to yellow? Explain why. [2]

(b) Sean wanted a control for his experiment. Describe how he should prepare the control set-up. [1]

PLEASE DO NOT WRITE IN THIS MARGIN (Go on to next page)

38 Tom released a ball from his hand and kicked the ball up into the air as shown in the diagram below.

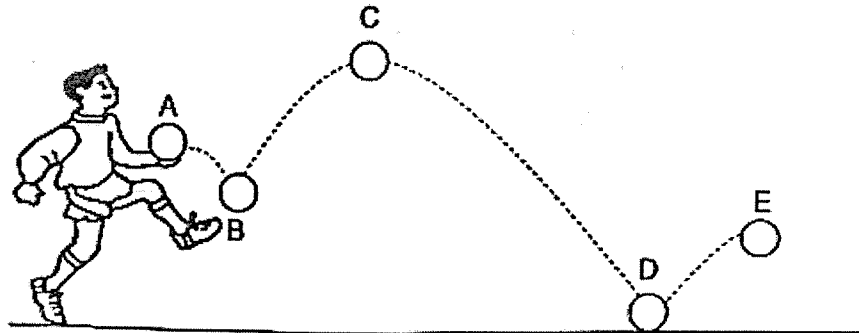

(a) State the effect of gravitational force on the ball after it was released from Tom's hand at point A. [1]

(b) State two effects of the force Tom exerted on the ball when he kicked the ball into the air at point B. [1]

(c) Draw a line graph to show how gravitational force acted on the ball as it moved from points A to E. [1]

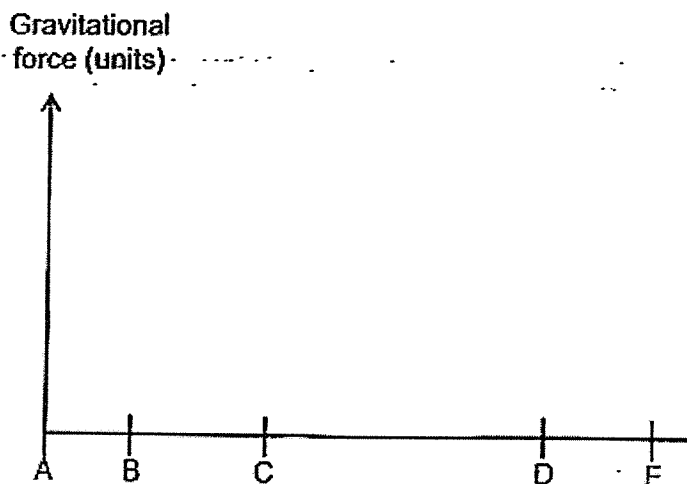

PLEASE DO NOT WRITE IN THIS MARGIN (Go on to next page)

- (d) Tom kicked a second ball of a greater mass with the same force in the same direction.

Will the height of the second ball at point C be higher, lower or the same? Explain your answer. [2]

PLEASE DO NOT WRITE IN THIS MARGIN (Go on to next page)

- 39 Insect B lays many eggs on the leaves of plants near the nest of insect A. When the eggs of insect B hatch, the young of insect B drop to the ground. The young of insect B smell and sound very similar to the young of insect A.

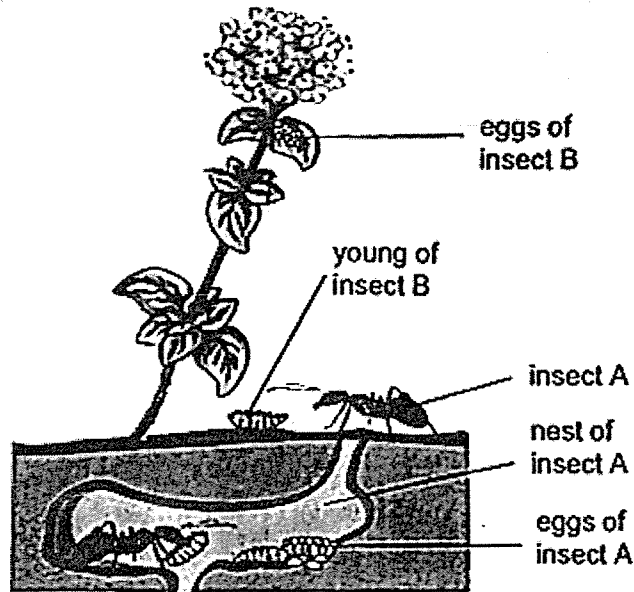

Insect A will pick up the young of insect B from the ground and bring them back to its nest to look after.

- (a) Why does insect B lay many eggs at one time? [1]

- (b) Give a reason why it is an advantage for insect B to lay its eggs near the nest of insect A. [1]

PLEASE DO NOT WRITE IN THIS MARGIN (Go on to next page)

- (c) Give a reason why it is an advantage for the young of insect B to smell and sound like the young of insect A. [1]

- (d) The young of insect B will feed on the young of insect A.
If there is an increase in the number of insect B's young which made it into the nest of insect A, predict what will happen to the population of insect A and insect B over time. Explain your prediction. [2]

PLEASE DO NOT WRITE IN THIS MARGIN (Go on to next page)

40 Gary went on a field trip and came across animal T and animal F.

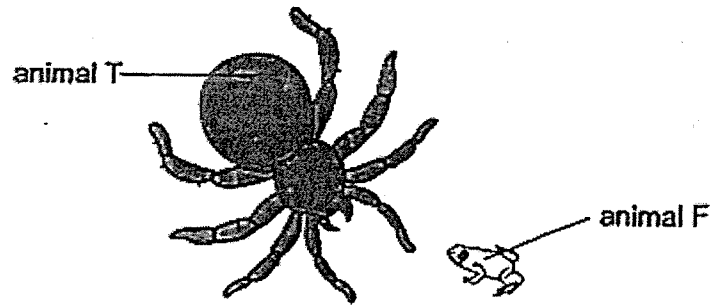

Gary found out more information about animal T and animal F. He then wrote the following in his notebook.

Animal T	Animal F
<ul style="list-style-type: none"> • lays tiny eggs on land • eggs eaten by small insects 	<ul style="list-style-type: none"> • lays tiny eggs in water • feeds on small insects

(a) Suggest a possible reason why T does not feed on F. [1]

(b) Suggest a possible benefit for F to be near T. [1]

(c) What is the benefit to Animal T when Animal F is found near its nest? [1]

PLEASE DO NOT WRITE IN THIS MARGIN (Go on to next page)

41 The diagram below shows several processes between living things and their surroundings.

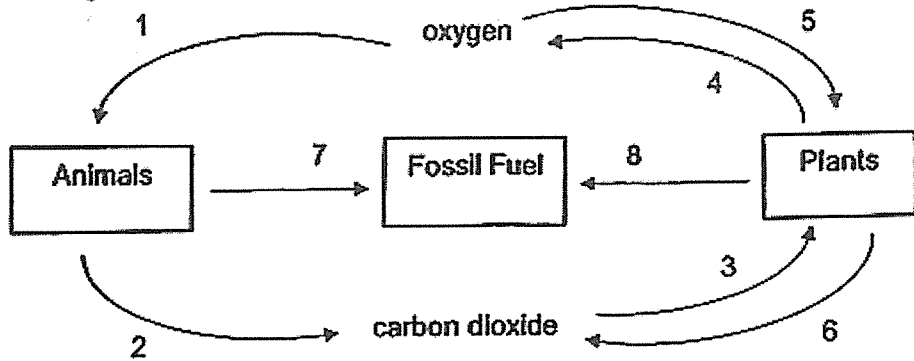

(a) Which 2 arrows show the process which takes the longest time to complete? [1]

(b) Explain how having many cars running on petrol on the road can lead to global warming. [1]

(c) Explain how global warming may affect small islands. [1]

- End of paper -

PLEASE DO NOT WRITE IN THIS MARGIN

—

L

-

-

SCHOOL : PEI HWA PRIMARY SCHOOL
LEVEL : PRIMARY 6
SUBJECT : SCIENCE
TERM : 2023 PRELIMINARY EXAMINATION

SECTION A

Q1	Q2	Q3	Q4	Q5	Q6	Q7	Q8	Q9	Q10
1	4	3	1	3	4	1	3	4	1
Q11	Q12	Q13	Q14	Q15	Q16	Q17	Q18	Q19	Q20
4	4	2	3	2	3	2	1	4	2
Q21	Q22	Q23	Q24	Q25	Q26	Q27	Q28		
3	4	3	3	1	4	1	1		

SECTION B

Q29a	C, D, A, B
Q29b	No Gary has to test if the material is flexible. Or. No Gary has to test if the material is waterproof.
Q30a	X: Digestive System Y: Circulatory System Z: Respiratory System
Q30b	The circulatory system will take in the digested food from the digestive system, the digested food would then be absorbed through the bloodstream into the heart, the heart will pump blood containing digested food and oxygen to the cells.
Q31a	Animal W lives in habitats that are dark and wet.
Q31b	He should compare which part has the most amount of W.
Q31c	He must allow more time for W to move to their preferred place.
Q32a	A Frame: Y B Frame: Z

	C Frame: X
Q32B)	To ensure that no light from other light sources would affect the experiment.
Q32C)	Light travels in a straight line.
Q33A)	One strip with the wax would take a shorter time for the wax to melt, while the other strip with wax would take a longer time to melt.
Q33B)	The thickness of the strip. This would ensure that there would only be one change variable. Length of strip distance between the heat source and wax are the same
Q33C)	K is a poorer conductor of heat than J. Water vapour came into contact with the cooler surface of K, lost heat and condensed to form tiny water droplets.
Q34A)	Part A: Anther Part B: Stigma Part C: Filament Part D: Ovary
Q34B)	E would be the seeds for the fruit after fertilisation has taken place.
Q35A)	Y is made of copper: Not possible to tell B1 is brighter than B3: False If B4 is removed, B2 will light up: False X and Z are electrical insulators: True
Q35B)	When one bulb fuses the other would not fuse and continue to work
Q35C)	User has the control over the time to switch on or off the circuit
Q36A)	Gravitational Potential → Kinetic → Kinetic
Q36B)	Longer. The block will move a longer distance as the bar possesses more kinetic energy. Less kinetic energy is converted to less heat energy due to reduced friction between the bar and ramp, so more kinetic energy of the bar was transferred to more kinetic energy of the block.
Q37A)	Set up B and D. Setup B has a black cloth around the tube and prevent light from getting trapped by the water plant. For photosynthesis to make food and preventing exchange of gases. Setup D has a water snail which would inhale oxygen and exhale carbon dioxide.
Q37B)	the control setup should only have liquid X in the sealed test tube.

Q38A)	The ball fell towards the ground
Q38B)	The direction and the ball sped up changed when tom kick the ball
Q38C)	<p>Gravitational force (units)</p>
Q38D)	Lower. The second ball is heavier and had the same amount of force to kick the ball. Tom needs to kick the ball with more force on the ball of greater mass against gravity to the same height as the first ball
Q39A)	To increase the chances of some eggs hatching and reaching adult stage.
Q39B)	Laying the eggs nearer to insert A makes it easier for A to spot the young and increases the chances of insert A bringing them to the nest to look after them.
Q39C)	Young of B will be able to pass off to be the young of A and A would mistakenly look after young of B as its own offspring.
Q39D)	The population of A would decrease. As the young of insect B is the predator of the young of insect A, there would be more B to feed on A thus the population of A would decrease and the reproduction rate of A would decrease. Population of B decreases due to the lack of food as population of A decreases.
Q40A)	As small insects feed on T's eggs and F feeds on the small insects that feed of T's egg, T would think that F is harmful and not feed on F.
Q40B)	The predators of F would not be able to feed on animal F as animal T is there and protect it.

Q40C	When animal F is found near its nest, when small insects want to eat animal T's egg, animal F would feed on the small insects, preventing animal's T to be eaten by the small insects.
Q41A)	7 and 8
Q41B)	When there are more cars, more greenhouse gas will be produced. More greenhouse gases will lead to more heat from the sun being trapped.
Q41C)	The ice in the cold countries would gain heat from the heat trapped in earth and melt into water. The water level would increase and flood small islands.