



NAN HUA PRIMARY SCHOOL  
PRELIMINARY EXAMINATION 2023

PRIMARY 6

SCIENCE

(BOOKLET A)

Total Time for Booklets A and B: 1 hour 45 minutes

INSTRUCTIONS TO CANDIDATES

1. Write your name, index number and class in the spaces provided below.
2. Do not turn over the page until you are told to do so.
3. Follow all instructions carefully.
4. Answer all questions.
5. Use a 2B pencil to shade your answers on the Optical Answer Sheet (OAS).

**Marks Obtained**

Booklet A		/ 56
Booklet B		/ 44
Total		/ 100

Name: \_\_\_\_\_ (      )

Form Class P6 \_\_\_\_\_

Teaching Group 6: \_\_\_\_\_

Date: 22 August 2023

Parent's Signature: \_\_\_\_\_

---

This booklet consists of 20 printed pages.



For each question from 1 to 28, four options are given. One of them is the correct answer. Make your choice (1, 2, 3 or 4) and shade your answer on the Optical Answer Sheet.

(56 marks)

1 Which of the following statements about ferns is correct?

- (1) Ferns are a type of fungi.
- (2) Ferns are flowering plants.
- (3) Ferns reproduce by spores.
- (4) Ferns do not make their own food.

2 Animal P has six legs and a pair of wings. Its young has no wings but looks like the adult.

Which of the following is the life cycle of animal P?

(1)

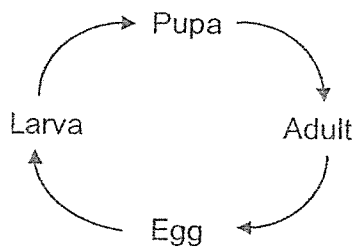

(2)

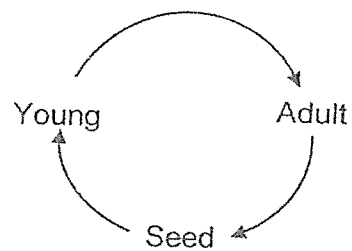

(3)

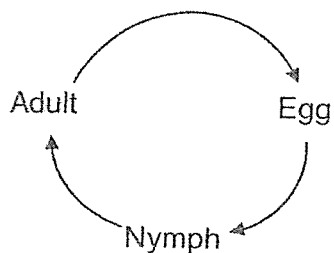

(4)

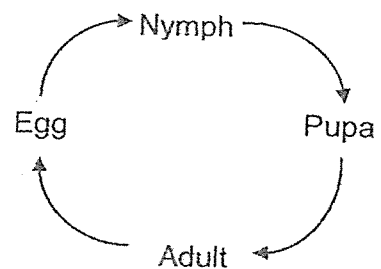

3 Which of the following statements about reproduction in flowering plants are correct?

- A A male flower cannot develop into a fruit.
- B Germination of seeds requires water, light and warmth.
- C Fertilisation fuses a pollen grain with an ovule of a flower.
- D A female flower without a stigma cannot develop into a fruit.

- (1) A and C only
- (2) A and D only
- (3) B and C only
- (4) C and D only

4 The diagrams below show the cross sections of flower S and fruit T.

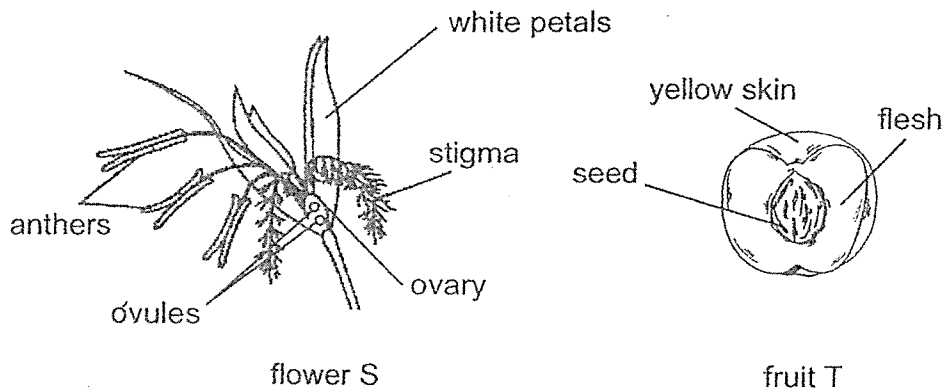

Which of the following explains why fruit T is **not** developed from flower S?

- (1) The ovary of flower S is much smaller than fruit T.
- (2) There are more ovules in flower S than seed in fruit T.
- (3) The colour of the petal is different from fruit T's skin colour.
- (4) Flower S is pollinated by wind whereas fruit T is dispersed by animal.

(Go on to the next page)

5 The diagrams below show the reproductive systems of humans and flowering plants.

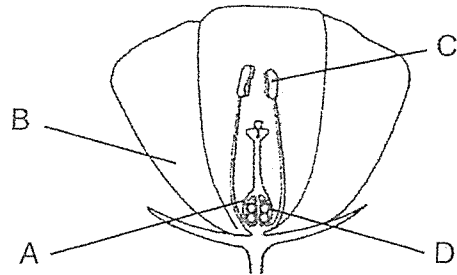
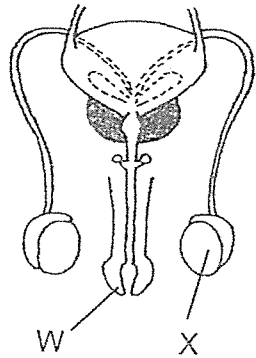

Which of the tables below correctly compares the functions of the human and flowering plant reproductive parts?

	Human		Plant	
	Part	Function	Part	Function
(1)	X	produces sperms	C	contains pollen grains
(2)	X	contains eggs	A	contains ovules
(3)	W	produces sperms	B	attracts insects
(4)	W	contains eggs	D	produces seeds

- 6 Water in plant X is lost through tiny openings in the leaves as they open. The diagram and the table below show how these openings look like and how they change in size with its surrounding temperature respectively.



<b>Surrounding Temperature (°C)</b>	28	32	36
<b>Size of opening</b>	small	medium	large

underside of a leaf taken from plant X  
(seen under a microscope)

The graph below shows the amount of water absorbed by the roots of plant X as its surrounding temperature changes.

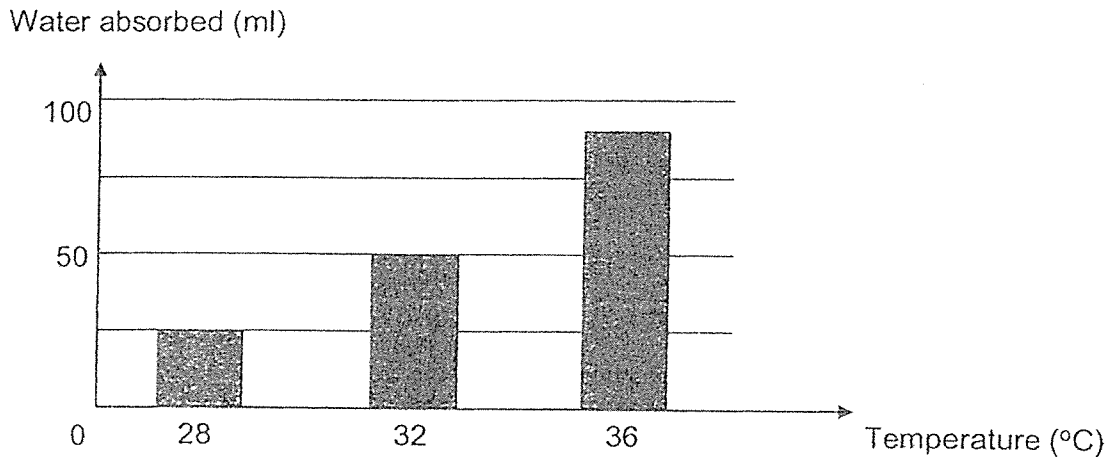

Based on the information above, which of the following statement is correct?

- (1) As the surrounding temperature increases, the size of openings on the leaves decreases.
- (2) As the size of openings on the leaves increases, the amount of water absorbed by plant X increases.
- (3) As the size of openings on the leaves increases, the amount of water absorbed by plant X decreases.
- (4) As the surrounding temperature increases, the amount of water absorbed by plant X decreases.

(Go on to the next page)

7 The diagram below shows a human digestive system.

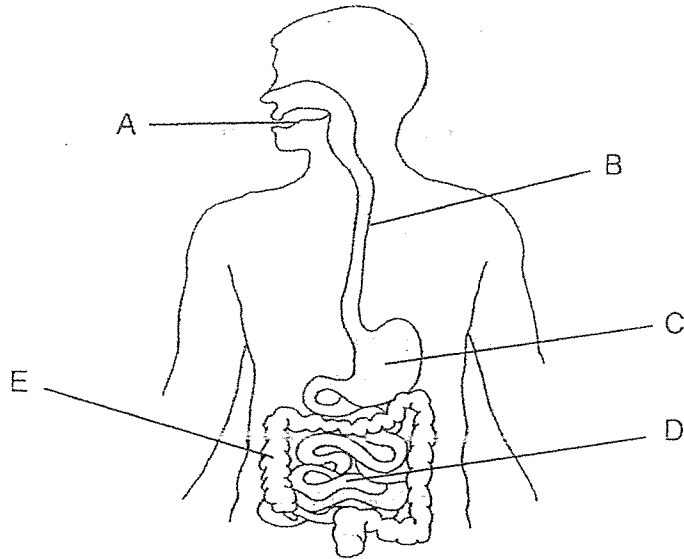

Which of the following graphs correctly shows the amount of undigested food left in the body immediately after leaving each organ, A, B, C, D and E?

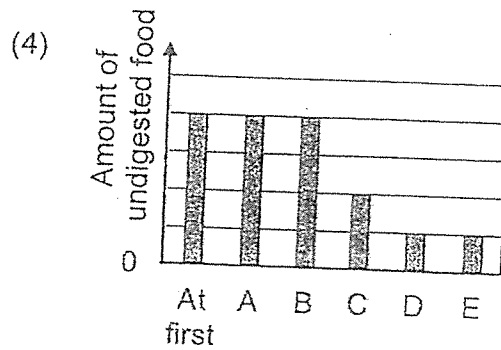
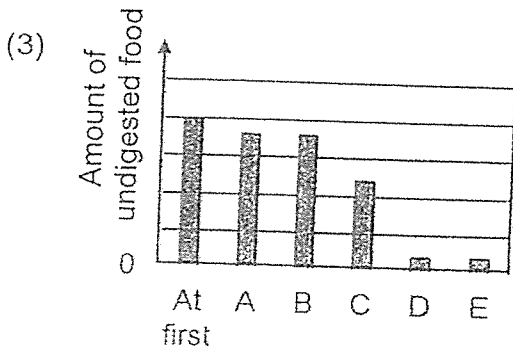
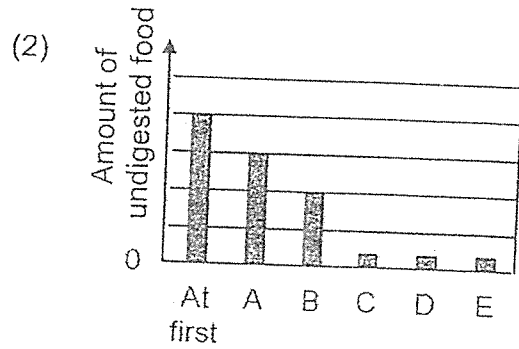
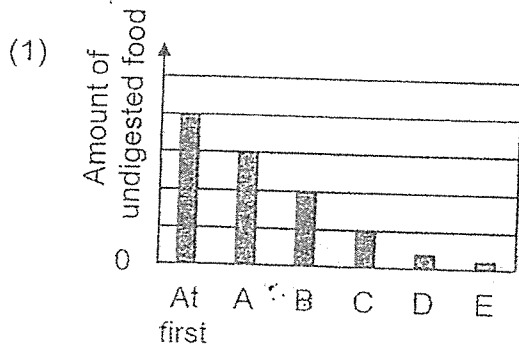

8 Which of the following makes up the human circulatory system?

- (1) heart, lungs and blood
- (2) heart and blood vessels
- (3) heart, blood and blood vessels
- (4) heart, lungs, blood and blood vessels

9 The diagram below shows what happens before and after an animal cell and a plant cell was placed in a container of liquid filled with substance W.

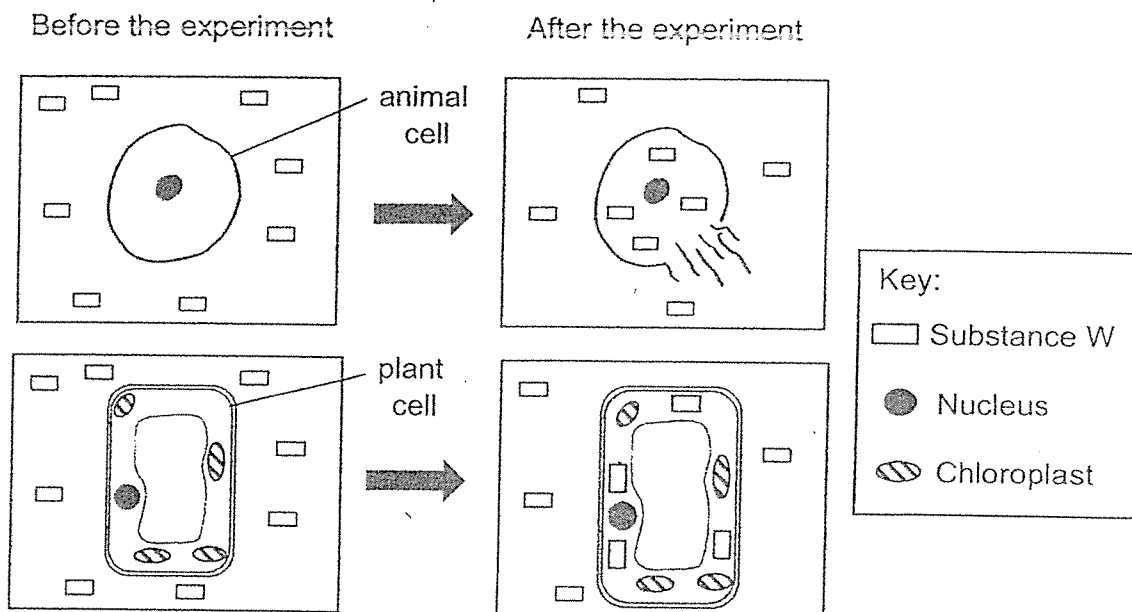

The observations at the end of the experiment are as follows:

- The plant cell swells.
- The animal cell burst.

Which of the following correctly explains the above observations?

- (1) The animal cell burst as it has no chloroplasts to stop substance W from entering it.
- (2) The plant cell did not burst as it has chloroplasts which contains chlorophyll to make food.
- (3) The plant cell did not burst as it has a cell wall which supports and maintains the cell's shape.
- (4) The animal cell burst as it has no cell membrane to control the amount of substance W entering it.

- 10 Pei Ling conducted an experiment on photosynthesis using the set-up below. All the leaves on the plant did not contain starch before the experiment. The potted plant was then watered and placed in a sunny location.

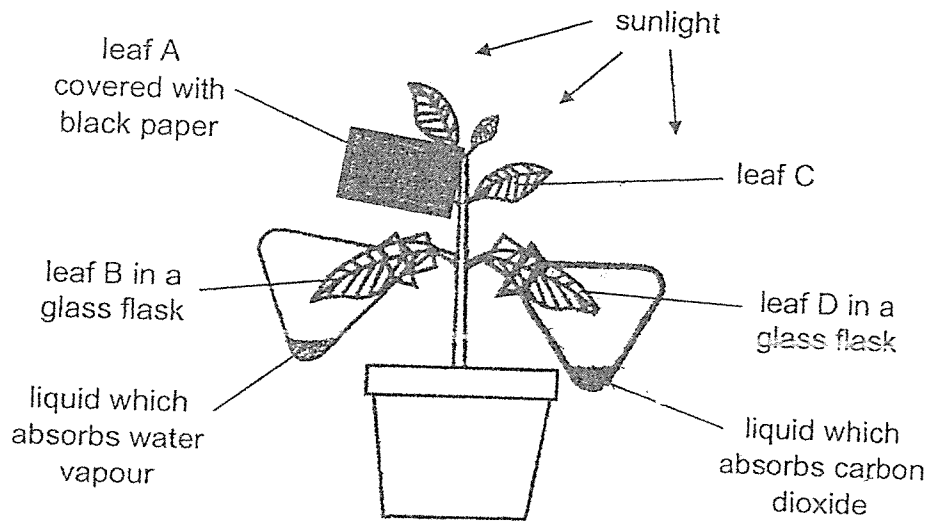

After a few hours, Pei Ling conducted a starch test on the four leaves, A, B, C and D using iodine solution.

Which of the following shows the correct test results?

	A	B	C	D
(1)	✓	X	X	X
(2)	X	✓	✓	X
(3)	X	✓	✓	✓
(4)	X	X	✓	✓

Key

✓ : starch present

X : starch absent

- 11 Aqif listed the type and number of animals he saw in a garden habitat below.

Type of animals	Quantity
frog	1
spider	3
butterfly	2
caterpillar	2
tadpole	1

Based on Aqif's list, how many populations of organisms did he see?

- (1) nine
  - (2) five
  - (3) three
  - (4) four
- 12 The food web below shows the flow of energy involving organisms P, Q, R, S and T.

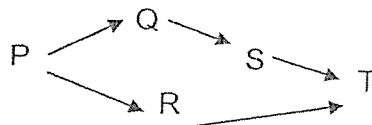

Which of the following statements is correct?

- (1) T is a food producer.
- (2) Q is a plant and animal eater.
- (3) Energy in P is transferred to R only.
- (4) Energy in T can be traced back to the sun.

(Go on to the next page)

- 13 Octopuses possess the ability to change their skin colour, pattern, and texture.

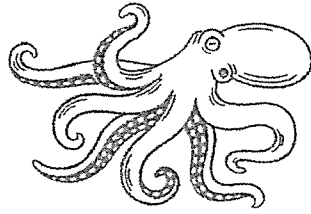

Which of the following correctly explains how this adaptation help an octopus survive in its environment?

- (1) This behavioural adaptation helps the octopus to hide from its predators.
  - (2) This behavioural adaptation makes the octopus attractive for finding its mate.
  - (3) This structural adaptation enables the octopus to ambush and hunt for its prey.
  - (4) This structural adaptation gives the octopus a streamlined shape to swim quickly.
- 14 Which of the following negative impacts is not due to deforestation?
- (1) soil erosion
  - (2) global warming
  - (3) oil spills on ocean
  - (4) destruction of habitats
- 15 A student made four statements about boiling and evaporation.
- A Boiling occurs on the surface of the liquid.
  - B Boiling of all liquids only occurs at a fixed temperature of 100 °C.
  - C Evaporation of a liquid occurs at any temperature below its boiling point.
  - D Both evaporation and boiling of liquids involve a change of state from liquid to gas.

Which of the statements above are correct?

- (1) A and B
- (2) A and C
- (3) B and D
- (4) C and D

16 Study the diagram below.

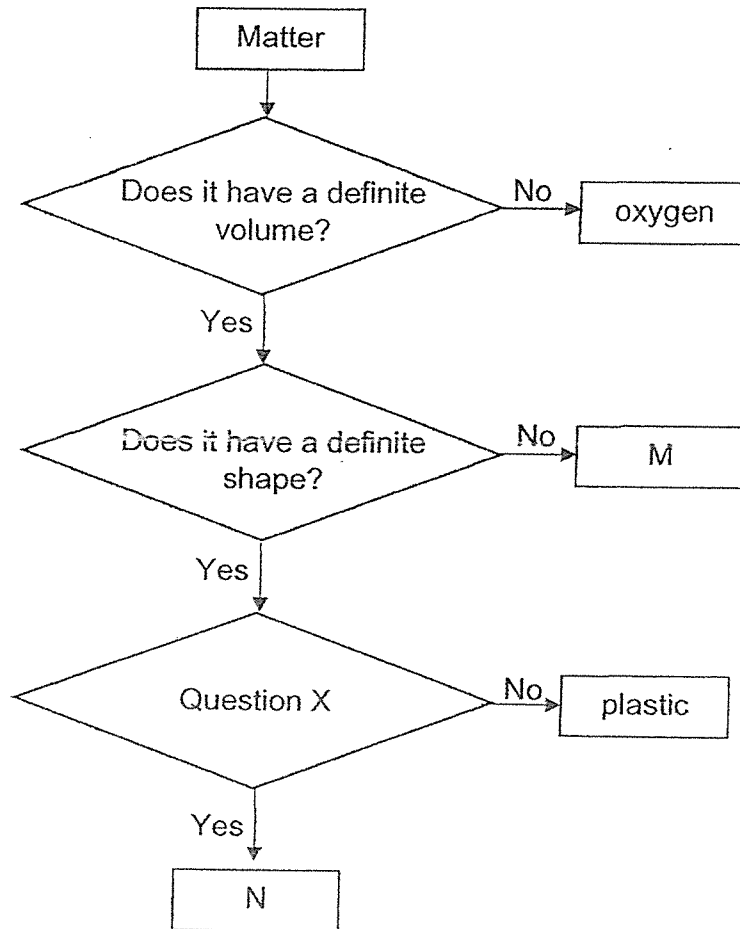

Which of the following option is correct?

	M	Question X	N
(1)	air	Does it conduct electricity?	aluminium
(2)	water	Is it a magnetic material?	iron
(3)	carbon dioxide	Is it a conductor of heat?	iron
(4)	oil	Is it a magnetic material?	wood

(Go on to the next page)

- 17 The diagram below shows the water cycle.

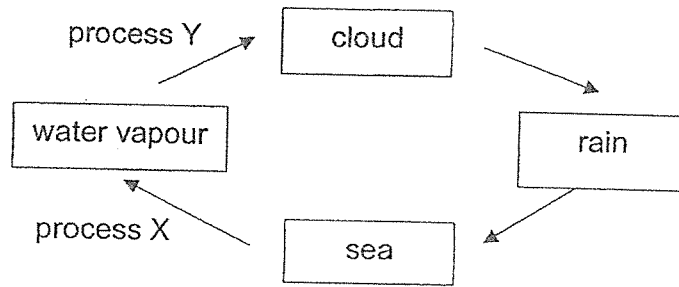

Enqi was boiling some water in an electric kettle when he noticed that there was some white mist above the spout of the kettle.

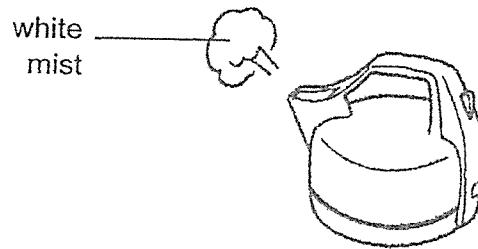

What is the state of mist and which process of the water cycle is similar to the formation of white mist shown?

	State of mist	Process
(1)	liquid	X
(2)	gas	X
(3)	liquid	Y
(4)	gas	Y

- 18 Samuel wanted to conduct an experiment to measure how the number of sheets of wrapping paper affects the amount of light passing through them.

He was given the following items as shown below.

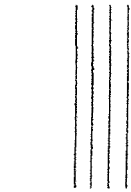

4 sheets of  
wrapping paper



torch



light sensor connected to  
a data logger

The steps to carry out the experiment are listed below but not in order.

- A Place the torch facing the light sensor.
- B Measure the amount of light given out by the torch using the light sensor.
- C Repeat the same experiment with increasing number of sheets of wrapping paper.
- D Place a wrapping paper between the torch and the light sensor and measure the light given out by the torch using the light sensor.

What is the correct order of the steps Samuel should take to carry out this experiment?

- (1) D, A, B, C
- (2) C, D, A, B
- (3) C, A, D, B
- (4) A, B, D, C

- 19 Kat filled four identical containers, P, Q, R and S, with different volumes of water. She added in an identical size of meat into each container and recorded the time taken for the food to be cooked completely. Her results are shown in the table below.

Container	Volume of water / ml	Time taken for the piece of meat to be cooked completely / min
P	300	1
Q	1000	4
R	300	8
S	1000	1

Based on the results above, which one of the following statements is correct?

- (1) The water in container Q has less heat than container S.
  - (2) The water in container R has more heat than container P.
  - (3) The temperatures of water in containers P and S were the same.
  - (4) The temperature of water in container S was lower than container Q.
- 20 Which of the following are sources of energy?

- A Sun
- B Wind
- C Petrol
- D Running water

- (1) A and B only
- (2) A and C only
- (3) A, B and C only
- (4) All of the above

21. Melanie wanted to investigate how the potential energy of the block is dependent on its height from where it was released. She used metal blocks of the same size to set up her experiment as shown below.

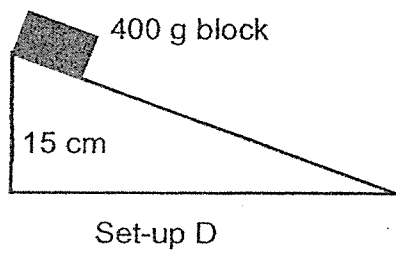
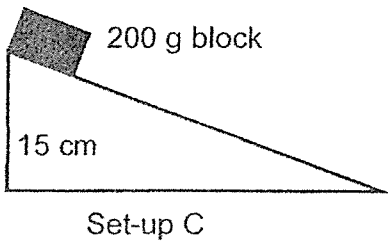
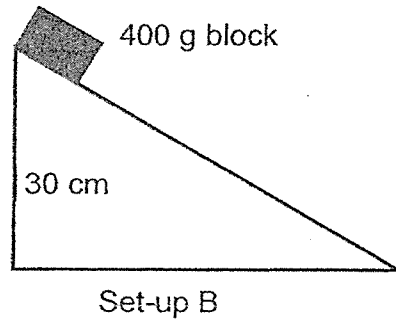
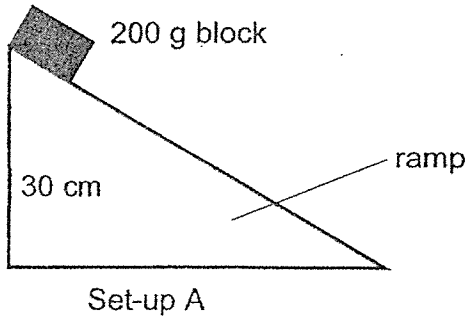

Which pairs of set-ups should she use in her experiment and what is the measured variable in this experiment?

	Set-ups used	Measured variable
(1)	A and B	mass of the block
(2)	A and C	time taken for block to reach the bottom of the ramp
(3)	B and C	time taken for block to reach the bottom of the ramp
(4)	B and D	mass of the block

(Go on to the next page)

- 22 Peter wants to find out how the arrangement of the bulbs affect the brightness of the bulb. He set up the four electric circuits using identical batteries and bulbs in working condition.

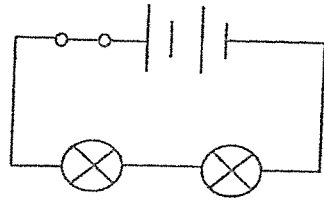

circuit P

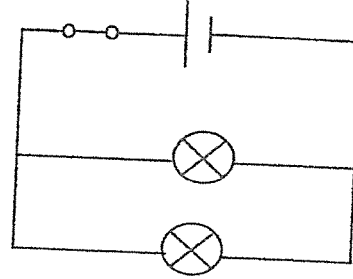

circuit Q

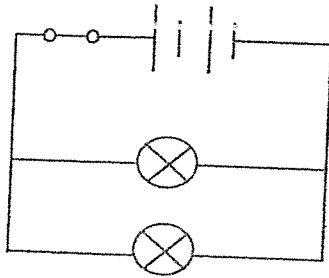

circuit R

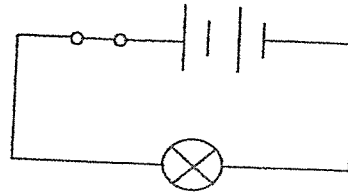

circuit S

Which pair of circuits could he use for his experiment?

- (1) P and Q
- (2) P and R
- (3) R and S
- (4) Q and S

23 Study the circuit.

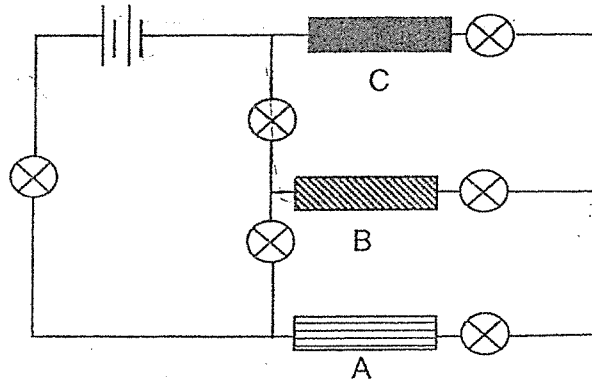

A, B and C are made of different materials.

Which of the following shows the correct number of bulbs that will be lit when the materials are at the various locations?

	A	B	C	Total number of bulbs lit
(1)	steel	iron	wood	5
(2)	iron	steel	wood	3
(3)	steel	wood	iron	3
(4)	wood	steel	iron	4

(Go on to the next page)

- 24 The diagram below shows two bumper cars in a non-sheltered outdoor amusement park. Part P is made of a material that can be compressed when the cars hit each other. This is to prevent damage to the cars.

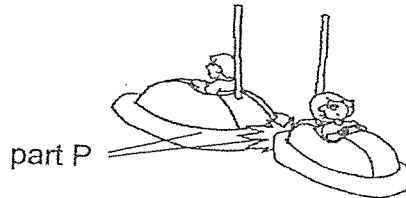

Below are some of the material(s) and their properties considered to make part P.

Material	Flexible	Waterproof	Breaks easily
A	✓	✓	X
B	X	X	✓
C	✓	X	X

Key

✓ : yes

X : no

Which of the following material(s) is/are suitable for making part P?

- (1) material A only
  - (2) material C only
  - (3) material A and B
  - (4) material B and C
- 25 The diagram below shows the side view of a magnet on a fridge door.

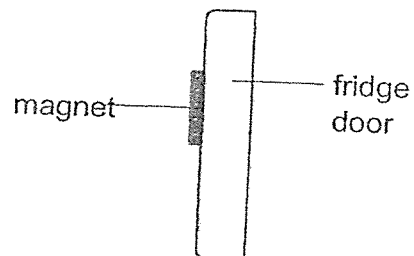

Which force(s) is/are acting on the magnet to prevent the magnet from dropping from the fridge door?

- (1) frictional force only
- (2) magnetic and frictional force only
- (3) gravitational force and magnetic force only
- (4) gravitational force, frictional force and magnetic force only

- 26 Peter kicked an empty can on the floor as shown in the picture below.



What is/are the possible effect(s) of forces shown when he kicked the empty can?

- A The moving can changes its speed.
- B The moving can stops when it lands on the floor.
- C The can changes its shape as it lands on the ground.
- D The moving can changes its direction when it hits a wall.

- (1) A only
- (2) B only
- (3) A, B and C only
- (4) All of the above

- 27 There are two bottles P and Q of the same size. Each bottle has a different groove pattern on its cap.

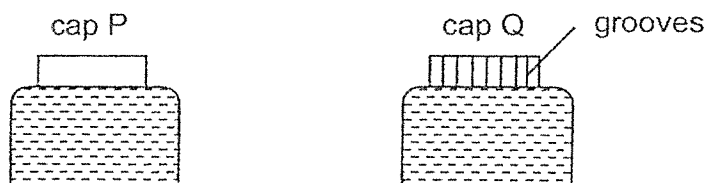

Which cap will be the easier to unscrew and why?

	Bottle	Reason
(1)	P	The cap without grooves is the smoothest for the person to unscrew it easily.
(2)	P	The cap has the more exposed surface area in contact with the fingers of the person trying to unscrew the cap.
(3)	Q	The cap has more grooves to increase the friction between the cap and fingers.
(4)	Q	The cap with grooves allows the finger to slide easily on the cap to unscrew it.

- 28 The diagrams below show the cross-section of a toaster.  
 Diagram A shows two springs at their original length when the bread is put into the toaster.  
 Diagram B shows how the two springs have been extended when the bread is lowered into the toaster.

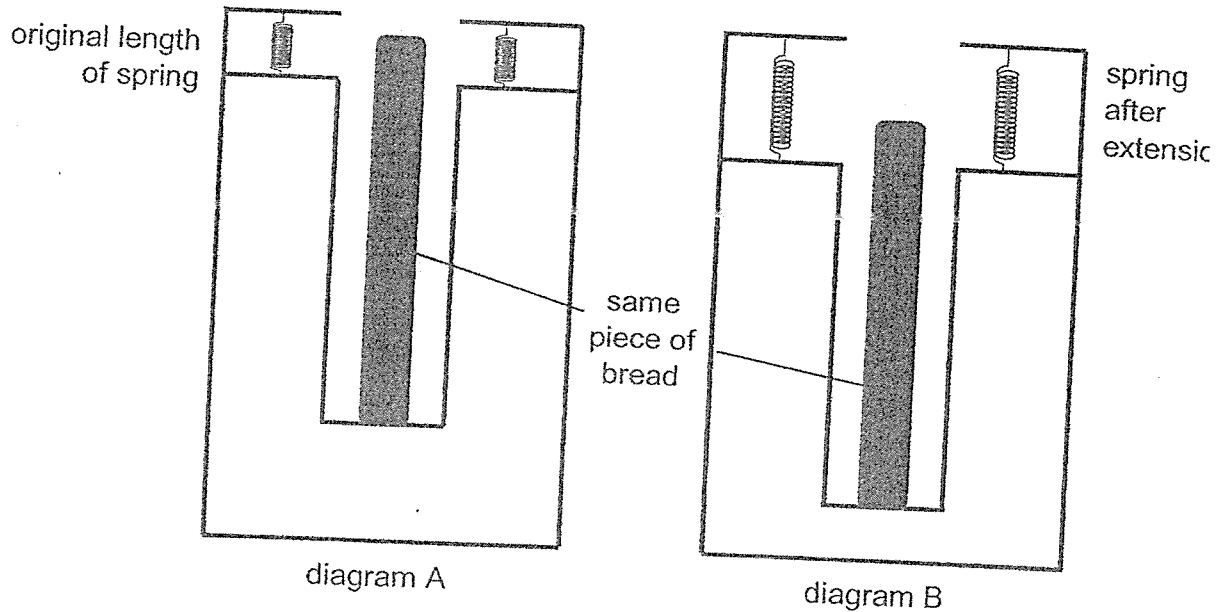

After the bread is toasted, the spring will return to its original length as shown in diagram A and the bread will pop out.

How could the toaster be modified so that the bread can pop out higher?

- A replace with stiffer springs
  - B use a piece of bread with lesser mass
  - C add another similar spring to each side of the toaster
- (1) C only  
 (2) A and B only  
 (3) A and C only  
 (4) All of the above

(Go on to Booklet B)





NAN HUA PRIMARY SCHOOL  
PRELIMINARY EXAMINATION 2023

PRIMARY 6

SCIENCE

(BOOKLET B)

Total Time for Booklets A and B: 1 hour 45 minutes

INSTRUCTIONS TO CANDIDATES

1. Write your name, index number and class in the spaces provided below.
2. Do not turn over the page until you are told to do so.
3. Follow all instructions carefully.
4. Answer all questions.
5. Use a dark blue or black ballpoint pen to write your answers in the space provided for each question.
6. Do not use correction fluid/tape or highlighters.

Marks Obtained

Section B

	/ 44
--	------

Name: \_\_\_\_\_ ( )

Class: P 6 \_\_\_\_\_

Teaching Group: 6S \_\_\_\_\_

Date: 22 August 2023

Parent's Signature: \_\_\_\_\_

---

This booklet consists of 17 printed pages and 1 blank page.

For questions 29 to 40, write your answers in the spaces provided.  
The number of marks available is shown in brackets [ ] at the end of each question or part question.

(44 marks)

- 29 Butterflies are commonly found near flowering plants. Butterflies help in the process of pollination.

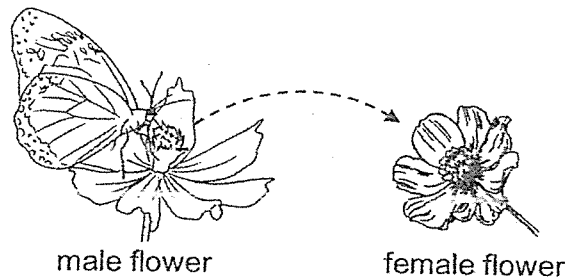

- (a) State what pollination is.

[1]

---



---

The table below shows the characteristics of flowers that two animal pollinators, P and Q, are attracted to. A tick [✓] indicates that the pollinator is attracted to the particular characteristic.

Characteristics of flower	pollinator P	pollinator Q
Small petals	✓	✓
Large petals	X	✓
Small amount of nectar	✓	X
Large amount of nectar	✓	✓
Presence of pollen grains	✓	X

Key  
✓ : Yes  
X : No

The diagram of a flower is shown below.

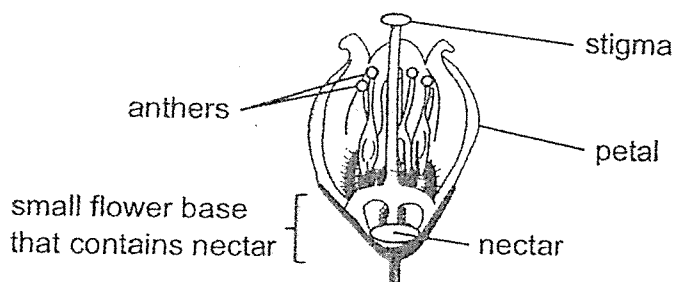

- (b) Using the table and diagram (on page 2), give two reasons why P is more likely to pollinate the flower than Q. [2]

Reason 1:

---

---

Reason 2:

---

---

The diagram below shows some fruits. The fruits, containing the seeds, are eaten whole by the animals.

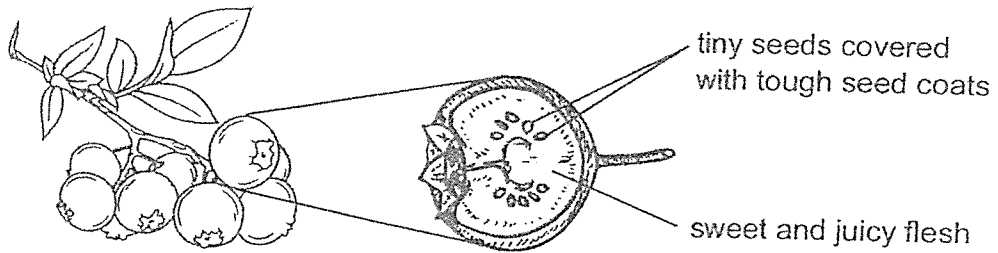

- (c) Explain how the tough seed coats helps in the dispersal of the seeds. [1]

---

---

(Go on to the next page)

Score	4
-------	---

- 30 Ravi prepared three set-ups in a classroom to find out if the presence of roots affects the amount of water absorbed by a plant as shown below. He recorded the amount of water left in the jars after a few hours. The diagram for Ravi's control set-up was incomplete.

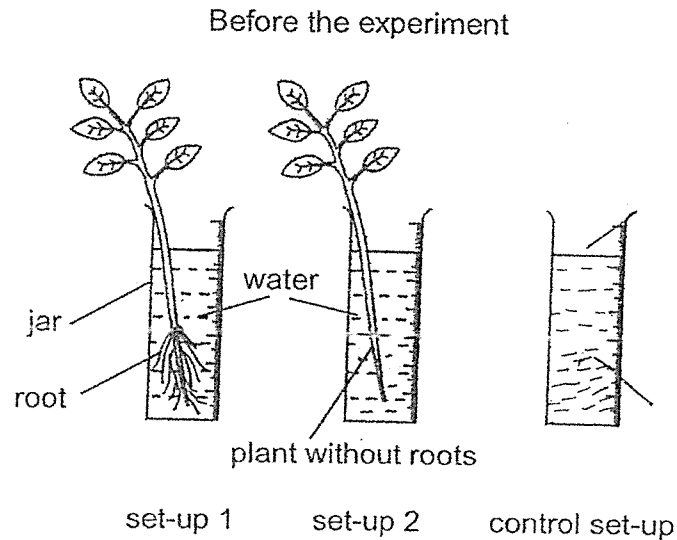

- (a) Draw to complete Ravi's control set-up above. Label your drawing. [1]

After some time, Ravi recorded his results for set-up 1 and 2 below. He also calculated the amount of water evaporated using his set-ups.

	Result S	Result T
Amount of water at first (ml)	600	600
Amount of water left (ml) in the jar	400	500
Amount of water evaporated (ml)	10	10

- (b) Which set of results belongs to set-up 1? Explain your answer. [1]

---



---

In another experiment, Ravi cut the bottom of a plant and dipped its stalks in different coloured dye as shown below.

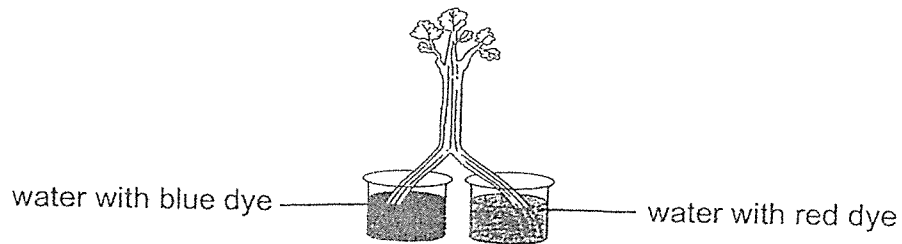

After some time, half the stalk and leaves turned blue while the other half turned red.

- (c) Explain why purple (mixing of the two colours) is not observed in the plant. [1]

---

---

(Go on to the next page)

Score	3
-------	---

31 The diagram below shows the direction of blood flow in some parts of the human body.

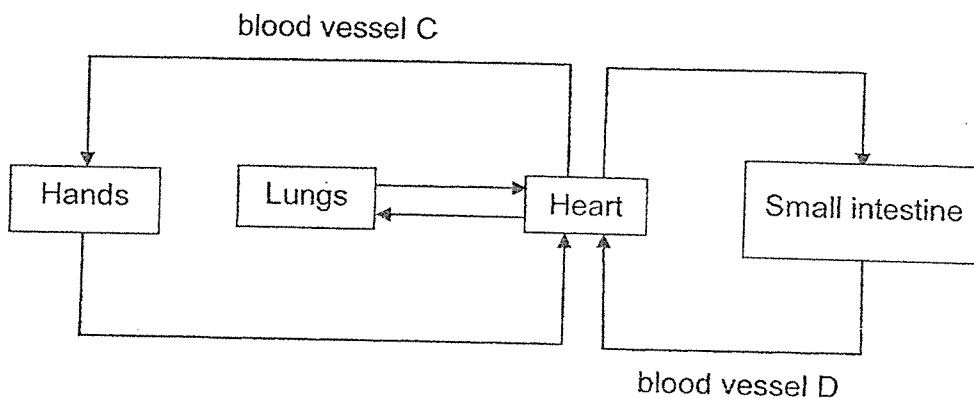

(a) Blood vessel D contains a greater amount of dissolved gas Y than blood vessel C.

Identify gas Y.

[1]

Y: \_\_\_\_\_

(b) Using the diagram above, describe how muscle cells in the hands receive oxygen and digested food to perform its daily function. [2]

---



---



---



---

- (c) The graph below shows the heart rate of Farah before, during and after her exercise.

Number of heart beats (per min)

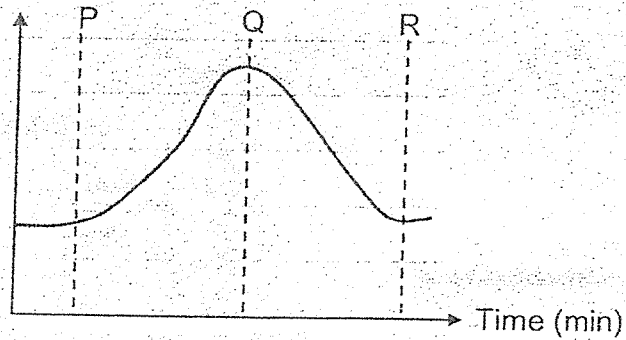

In the table below, fill in each blank with either “increase” or “decrease” to represent the changes in Farah’s body. [1]

Period P to Q		Period Q to R
Breathing rate	Amount of carbon dioxide breathed out	Amount of digested food used by Farah’s body
(i)	(ii)	(iii)

(Go on to the next page)

Score	4
-------	---

- 32 Leon set up an experiment as shown below to study the rate of photosynthesis of a water plant.

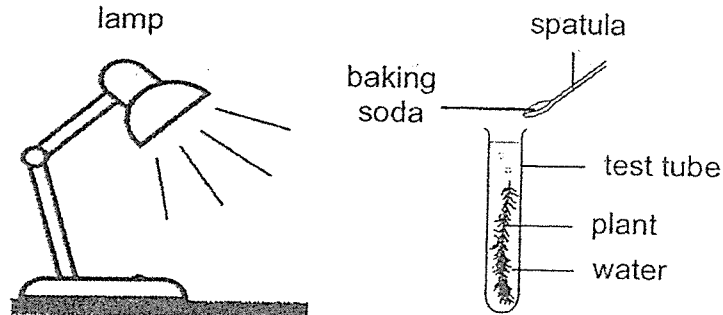

He added a spatula of baking soda into the test tube and counted the number of bubbles produced by the water plant in one minute. In each subsequent minute, he added one spatula of baking soda and counted the number of bubbles produced until four spatulas of baking soda are added.

Baking soda is added to increase the amount of carbon dioxide in the water.

- (a) State a possible hypothesis for the experiment. [1]

---

- (b) Leon did not move the lamp's position during the experiment. Suggest how this arrangement allowed for a fair test. [2]

---



---



---

- (c) Which of the following changes should Leon make (before starting his experiment) if he wants to observe more bubbles from the water plant? Put tick(s) [✓] in the correct box(es) below. [1]

Suggested change	Choice
1. Add more water plants.	<input type="checkbox"/>
2. Have less water in the test tube.	<input type="checkbox"/>
3. Move the lamp nearer to the water plant.	<input type="checkbox"/>

0009/02(B)

Score	4
-------	---

33 Study the food web below carefully.

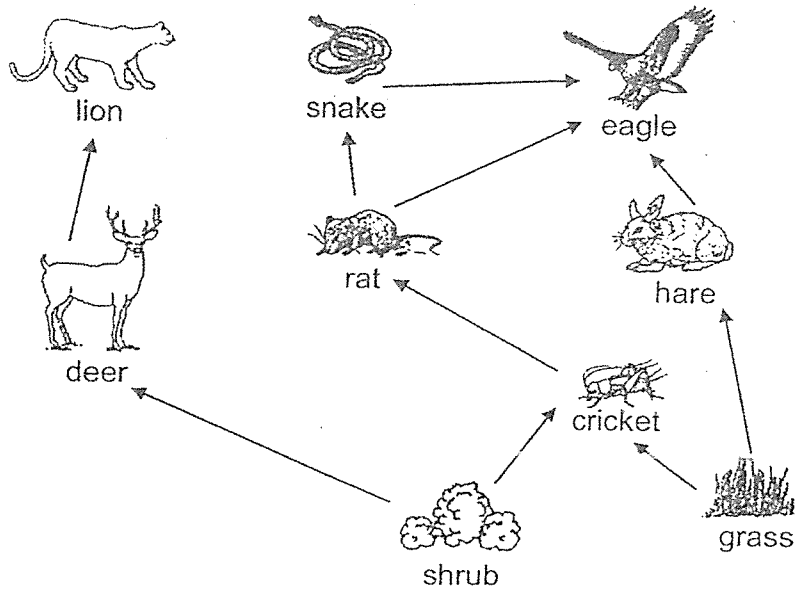

(a) List two organisms (from the food web) which are both a prey and a predator. [1]

---

(b) Which organisms will experience the greatest increase in population size if all the rats in the habitat are dead? [1]

Greatest increase: \_\_\_\_\_

(c) Explain why the population of lions would increase when the population of deers increased. [1]

---



---

Chemical Q, when eaten by one animal, can be passed on to all subsequent animals through a food chain.

(d) If all the animals in the above food web contain traces of chemical Q in their bodies except for the hare, state the source of chemical Q. [1]

---

(Go on to the next page)

0009/02(B)

Score	4
-------	---

- 34 Fish X, as shown below, has an oval suction pad on its head to attach to larger marine animals (hosts) to transport it to different parts of the ocean. The suction is strong but will not cause harm to its hosts.

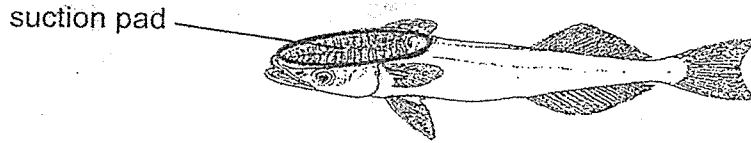

- (a) State a structural adaptation that allows fish X not to slow down its host when being attached. [1]

---

The diagram below shows fish X attached to a shark. The shark has its underside skin infested with fish lice.

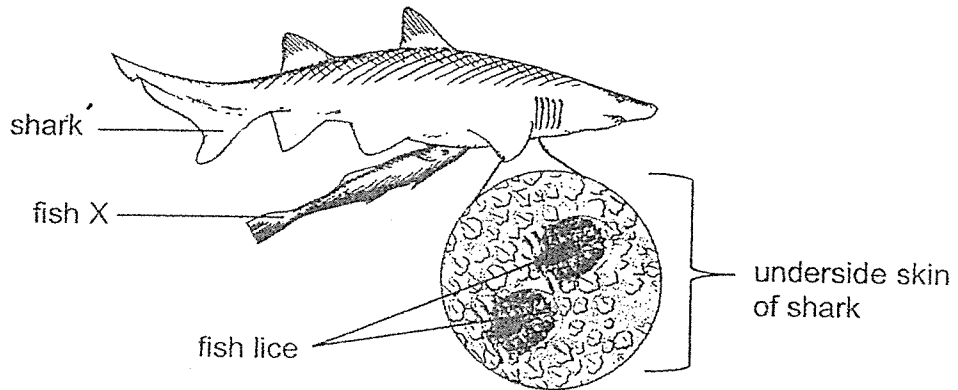

Fish lice are harmful organisms (parasite) that feed on a shark's blood and cause irritation and wounds.

- (b) Fish X could be found attracted to sharks near areas where fish lice are found. Suggest a reason why the shark allows fish X to attach to it and not feed on fish X. [1]

---

- (c) Fish X is eaten by a few marine animals. Explain how fish X would benefit from its relationship with the shark. [1]

---



---

Score	3
-------	---

- 35 The diagram below shows a pot that is used to separate the unwanted food particles from the oil. The oil will pass through the holes in the sieve into the pot while the food particles remained on the sieve. The oil can then be reused in subsequent cooking.

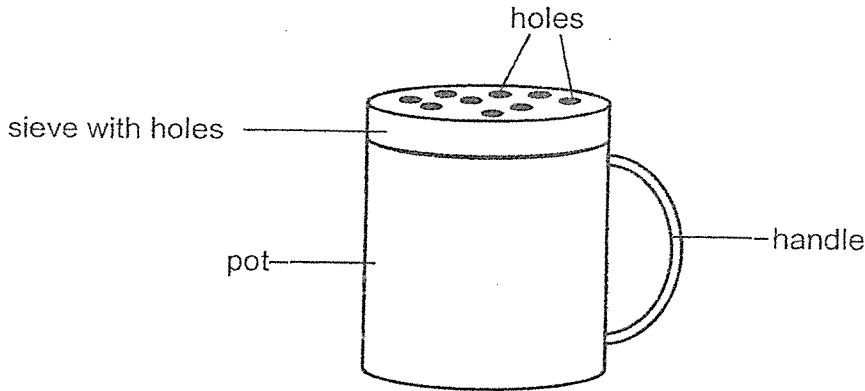

- (a) Identify the state of matter of the food particles that allows it to be collected on the sieve. [1]

---

- (b) State the property of oil that allows it to be collected at the bottom of the pot. [1]

---

- (c) Based on the diagram, explain why the handle of the oil pot should be made of plastic instead of metal. [2]

---



---



---



---

(Go on to the next page)

Score	4
-------	---

36 Bala bought a cooler box with two compartments as shown below.

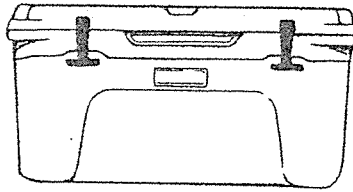

He placed different items into the cooler box. The cross-section of the cooler box containing the different items is shown below.

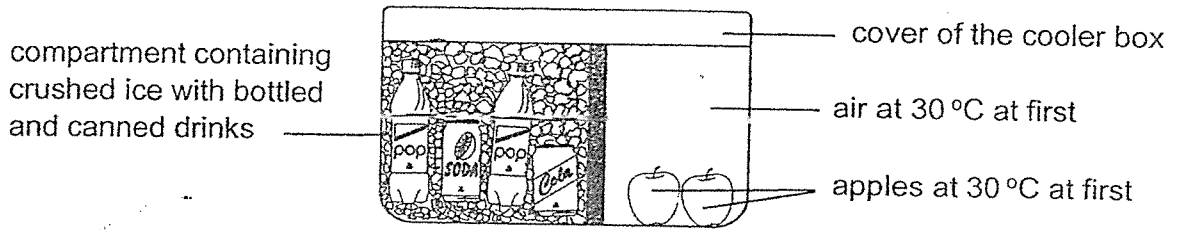

(a) Bala opened the cooler box to take out the apples after some time and discovered they were cooler. Explain why the apples were below 30 °C. [2]

---



---



---



---

(b) He placed the apples on a table and noticed that there were water droplets on them after a minute. Explain why water droplets appeared on the apple. [1]

---



---

Score	3
-------	---

- 37 Dawn was trying to take a picture of the car on the book using her handphone camera at night as shown in the diagram below. There is only one light source on the ceiling.

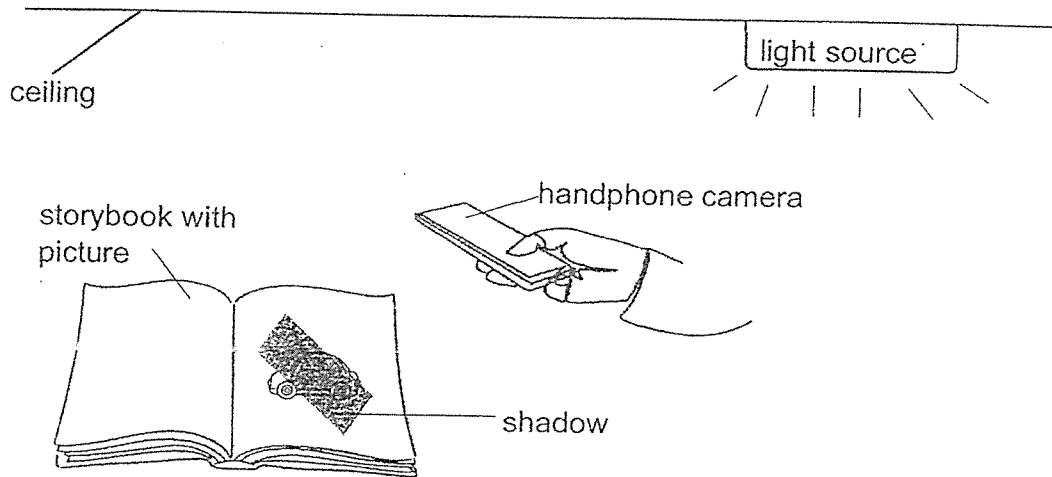

She was not able to do so as there is a shadow formed on the picture.

- (a) Explain why a shadow was formed on the picture. [1]

---



---

- (b) Put tick(s) on the following possible solution(s) to help her take a picture without the shadow forming on the book. [1]

- Shift the book closer to the light source and ensure that the picture is not under the camera
- Place both the handphone and book directly under the light source
- Turn off the light source in the diagram above

(Go on to the next page)

Score	2
-------	---

38 Peter set up a circuit using all of the components below:

- two identical working batteries
- some wires
- two switches (S1 and S2)
- two identical bulbs (A and B)

He then recorded which bulb(s) lit up when the switches were opened and/ or closed in the table below.

Switch 1	Switch 2	Bulb A	Bulb B
open	open	unlit	unlit
close	open	lit	unlit
open	close	unlit	unlit

(a) The box below shows part of the circuit diagram. Complete the circuit diagram with labelled switches so that it will work as described in the above table. [3]

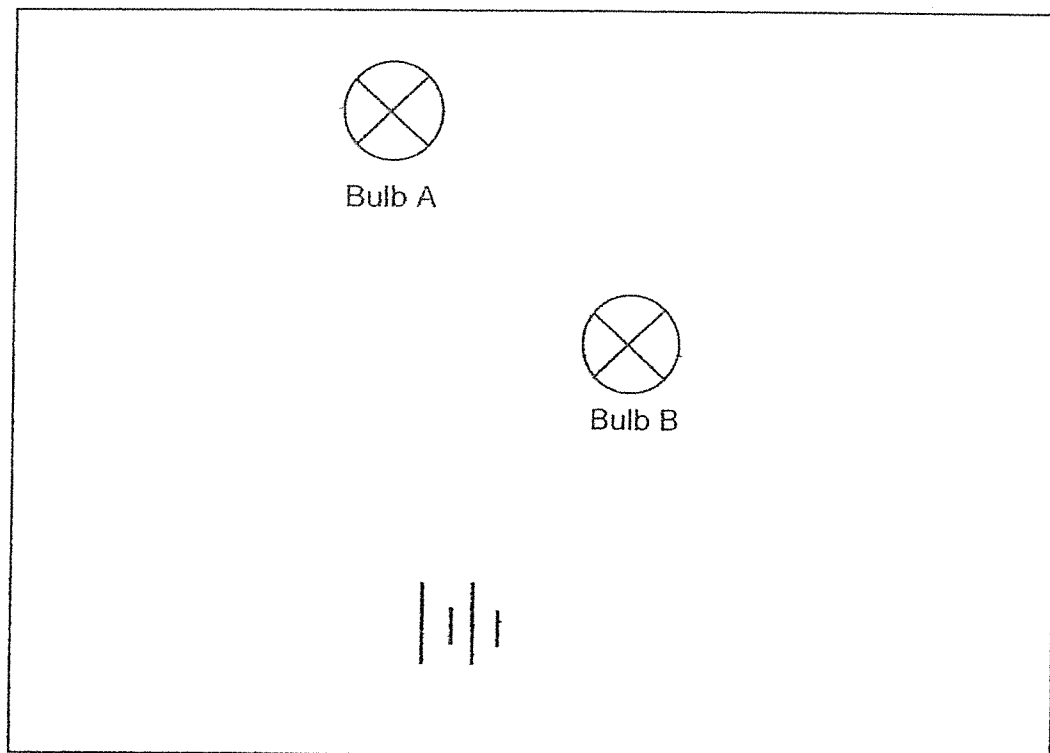

Most cars have a heating element at the back window. The heating element is connected to the battery of the car to clear the mist that is formed on the window.

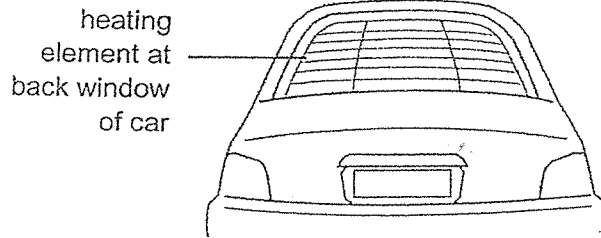

The diagrams below show two ways of connecting the circuit of the heating element.

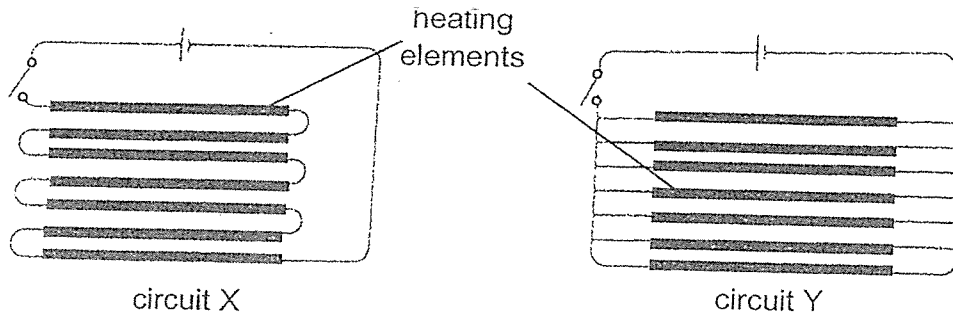

- (b) State the property of the heating element that allows it to work. [1]

---

---

- (c) Explain why car manufacturers prefer using circuit Y to make the heating element than circuit X. [1]

---

---

(Go on to the next page)

0009/02(B)

Score	5
-------	---

- 39 (a) Using a magnet, describe how an iron bar can become a magnet. [1]

---



---

The diagram below shows a circuit with a doorbell that makes a 'ding-dong' sound. The movable steel clapper rests on the 'dong' plate when the doorbell switch is open.

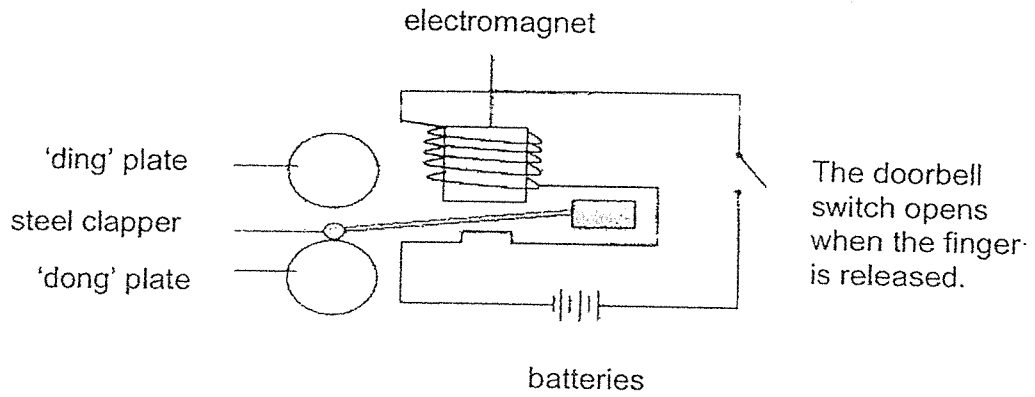

- (b) Using the diagram above, explain how an electromagnet enables the doorbell to produce a "ding-dong" sound when the switch is pressed once. [2]

---



---



---



---

- (c) Without changing the clapper and "ding" plate, suggest a possible way to make the "ding" sound louder. [1]

---

Score	4
-------	---

- 40 Lucy held a toy between her hands as shown below. She rotated the toy by sliding her right hand forward and her left hand backwards before releasing it. The toy flew to a certain height after it left her hands.

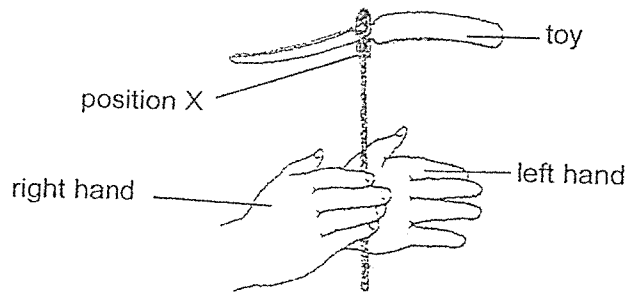

- (a) Fill in the boxes with the main forms of energy when the toy flew upwards as she released the toy. [2]

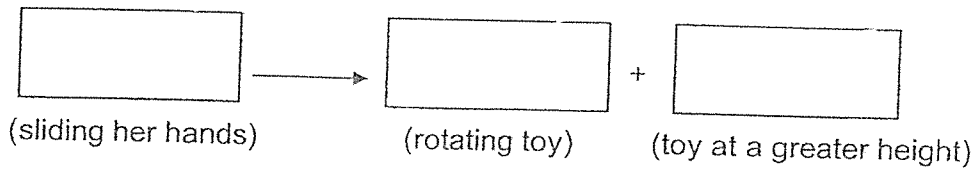

- (b) Lucy attached a piece of plasticine at position X shown above. She then rotated the toy again at the same starting position with the same amount of force.

Predict if the toy will fly higher, lower or at the same height after the toy is released. Explain, in terms of force, why the toy flew at the predicted height.

[2]

---



---



---



---

End of paper

0009/02(B)

Score	4
-------	---

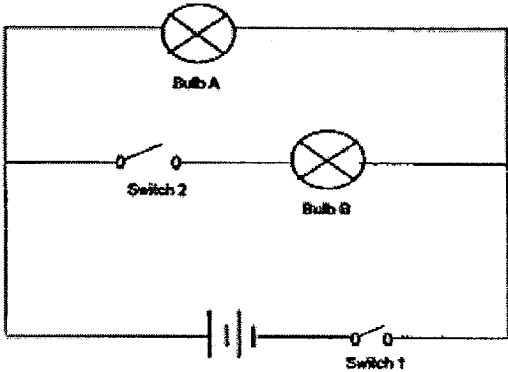

Qns	Prelims 2023 Answer
29a	Pollination is the process of transferring pollen (grains) from the anther onto the stigma of a flower / from a male to a female flower.
29b	Reason 1: P is attracted to the pollen (grains) found in the anthers of the flower (but not Q). Reason 2: P is attracted to the small amount of nectar (but not Q).
29c	When the fruits are eaten, the tough seed coats prevent / protect the seeds from being digested [1/2] so that the seeds could be dispersed through the animals waste/ droppings [1/2].
30a	To draw the water level at the same height as the other jars. To label "water" in the drawing.
30b	Result S. The presence of roots on the plant in set-up 1 enables the plant to absorb / take in more water. [1]
30c	The water-carrying tubes / xylems carry the water with blue and red dye in separate / different tubes. OR The water-carrying tubes / xylems that transport the water with blue and red dye are not connected / joint to each other.
31a	Y: Carbon dioxide
31b	The heart pumps blood [1/2] carrying digested food from the small intestine [1/2] and oxygen from the lungs [1/2] to the muscle cells / the hands [1/2]. (Idea of digested food in blood and oxygen in blood must be mentioned)
31c	i) Increase ii) increase iii) decrease
32a	The amount of carbon dioxide increases / decreases / does not affect the rate of photosynthesis of the water plant / number of bubbles produced by the water plant [1].
32b	This arrangement ensures that the rate of photosynthesis / number of bubbles produced by the water plant is only due to the amount of carbon dioxide / amount of baking soda / number of spatula of baking soda added [1] and not due to the amount of light received by the water plant [1].
32c	☐ Tick: "Add more water plants." ☐ Tick: "Move the lamp nearer to the water plant."
33a	Rat and snake
33b	Cricket

33c	As the population of the deer increases, the lions have more deer/prey to feed on/prey on. [1/2]. The lions can grow faster / better with more food and reproduce more / faster / have a greater rate of reproduction [1/2] to increase its population size / numbers.
33d	Shrub
34a	Streamlined body / body shape
34b	Fish X feeds on/prey on the fish lice / The fish lice are the food for fish X.
34c	The shark help to protect fish X from its predators.
35a	Solid
35b	The oil does not have a definite shape
35c	As plastic is a poorer conductor of heat (1) than metal, the plastic handle will gain less heat / gain heat slower from the hot oil (1/2) than the metal handle.(C) Thus, it may not injure/scald the user's hand (so easily) when hot oil is poured in (L) (1/2)
36a	The air surrounding the apples loses heat to the ice / cooler compartment. Thus, the air becomes cooler. [1] The apples lose heat to the cooler air. [1] Thus, the temperature of the apples will be lower/ the apples will be colder.
36b	The water vapour in the surrounding air (lost heat) to the cooler surface of the apple and condensed (to form water droplets).
37a	The light rays (from the light source) is blocked by the (opaque) handphone. Thus a shadow is formed on the picture
37b	Shift the book closer to the light source and ensure that the picture is not under the camera
38a	 <p>The diagram shows a rectangular circuit loop. At the bottom is a battery symbol. On the right vertical wire is a switch labeled 'Switch 1'. On the top horizontal wire is a bulb labeled 'Bulb A'. On the left vertical wire, there is a horizontal branch containing a switch labeled 'Switch 2' and a bulb labeled 'Bulb B' in series.</p>

<b>38b</b>	High melting point / conductor of electricity / good conductor of heat.
<b>38c</b>	If one of the heating element is not working/ functioning/spoilt, the other heating elements in circuit Y will still work, as it is still a closed circuit and electricity can still pass through the other heating elements.
<b>39a</b>	By stroking the iron bar with a magnet in 1 direction and repeatedly/ several times.
<b>39b</b>	When the switch is closed, electricity flows through the close circuit. The electromagnet then attracts the clapper which hit the 'ding' plate. [1] When the switch is opened, electricity stop flowing/ it is an open circuit and the electromagnet will no longer attract the clapper. The clapper returns to its original position / drops and hits the 'dong' plate. [1]
<b>39c</b>	Add more batteries / Add more coils of wire around the electromagnet.
<b>40a</b>	Kinetic energy → Kinetic energy + Gravitational Potential energy
<b>40b</b>	Fly lower. With the piece of plasticine attached, the toy will have more mass/add mass/mass increases [1] and more weight / a greater gravitational force acting on it [1]. Thus, the toy will fly lower.

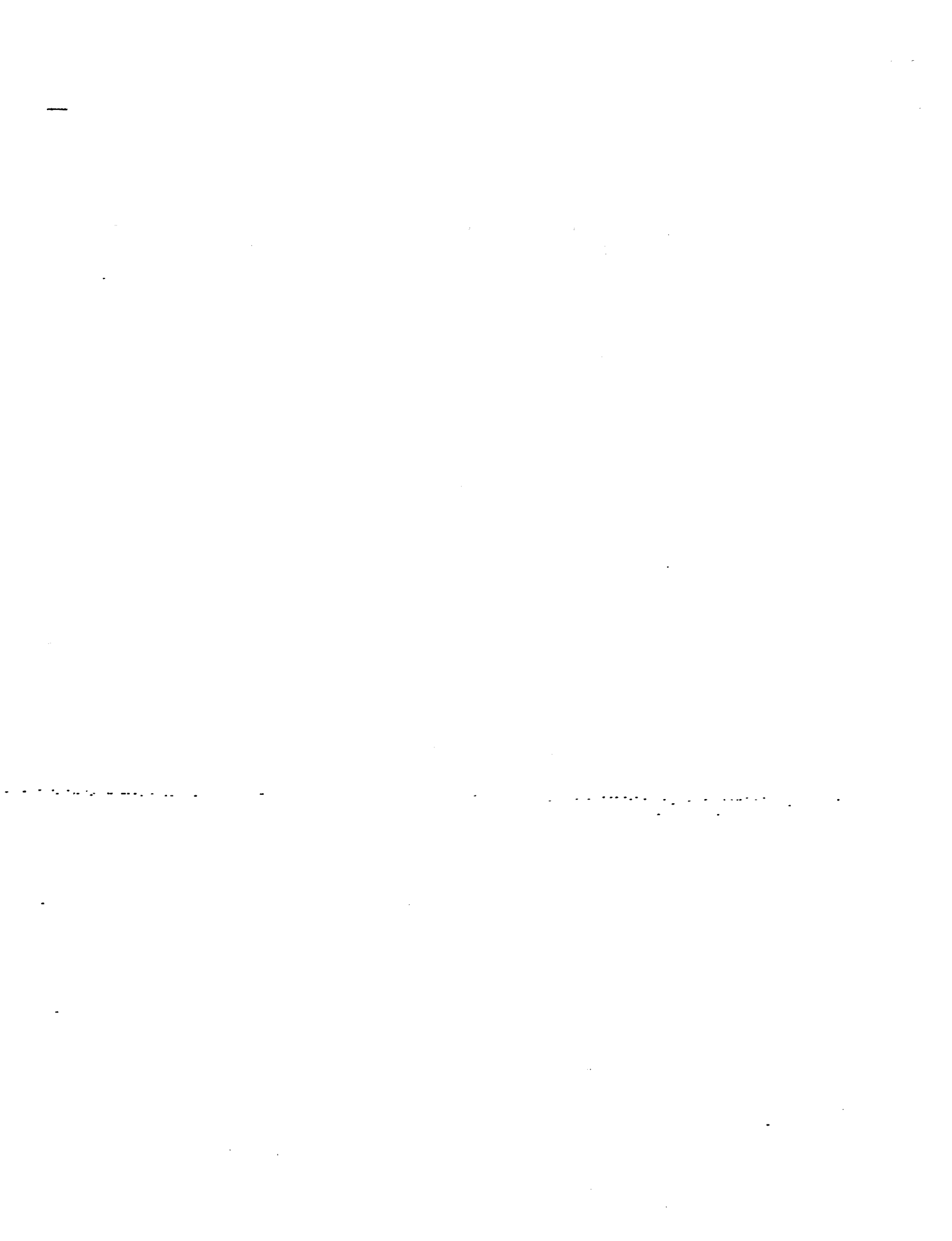

PRELIMS 2023  
PRIMARY SIX  
SCIENCE  
Pupil's Answer Key

Section A (28x2) = 56marks

Qns	Ans	Qns	Ans	Qns	Ans
1	3	11	3	21	2
2	3	12	4	22	2
3	2	13	3	23	1
4	2	14	3	24	1
5	1	15	4	25	2
6	2	16	2	26	4
7	3	17	3	27	3
8	3	18	4	28	3
9	3	19	1		
10	2	20	4		

**Section B (44 marks)**

Qns	Answer
29a	Pollination is the process of transferring pollen grains from the anther onto the stigma of a flower / between two flowers.
29b	Reason 1: P is attracted to the pollen grains found in the anthers of the flower (but not Q). Reason 2: P is attracted to the small amount of nectar (but not Q).
29c	When the fruits are eaten, the tough seed coats prevent / protect the seeds from being digested so that the seeds could be dispersed through the animals' waste/ droppings.
30a	To draw the water level at the same height as the other jars. To label "water" in the drawing.
30b	Result S. The presence of roots on the plant in set-up 1 enables the plant to absorb more water.
30c	The water-carrying tubes / xylems carry the water with blue and red dye in separate / different tub
31a	Carbon dioxide
31b	Oxygen in the lungs enters the bloodstream / blood. The heart pumps the blood rich in oxygen to the small intestine where digested food also enters the bloodstream / blood. The blood is then pumped to the muscle cells / hands.
31c	i) increase ii) increase iii) decrease
32a	The amount of carbon dioxide increases / decreases / does not affect the rate of photosynthesis of the water plant.

32b	This arrangement ensures that the rate of photosynthesis is only due to the amount of carbon dioxide and not due to the amount of light received by the water plant.
32c	Tick: "Add more water plants." Tick: "Move the lamp nearer to the water plant."
33a	Rat and snake
33b	Cricket
33c	As the population of the deer increases, the lions have <u>more deer</u> / prey to feed on <sup>and reproduce more</sup> to increase its population size / numbers.
33d	Shrub
34a	Streamline body / body shape
34b	Fish X feeds on/prey on the fish lice / The fish lice are the food for fish X.
34c	The shark help to scare away fish X's predators. Or The shark help to protect fish X from its predators.
35a	Solid
35b	The oil does not have a definite shape.
35c	As plastic is a poorer conductor of heat than metal, the plastic handle will gain heat slower from the hot oil than the metal handle. Thus, it may not injure / scald the user's hand when hot oil is poured in.

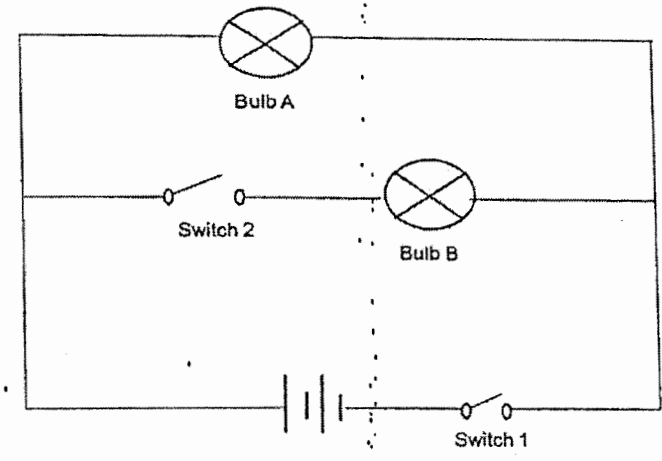
36a	The air surrounding the apples loses heat to the ice / cooler compartment. Thus, the air becomes cooler. The apples lose heat to the cooler air. Thus, the apples will be colder.
36b	The water vapour in the surrounding air lost heat to the cooler surface of the apple and condensed to form water droplets.
37a	The light rays (from the light source) is blocked by the (opaque) handphone. Thus, a shadow is formed on the picture.
37b	Shift the book closer to the light source and ensure that the picture is not under the camera.
38a	 <p>The diagram shows a rectangular circuit loop. At the bottom is a battery symbol. On the left vertical wire, there is an open switch labeled 'Switch 2'. On the top horizontal wire, there is a bulb symbol labeled 'Bulb A'. On the right vertical wire, there is a bulb symbol labeled 'Bulb B'. On the bottom horizontal wire, there is an open switch labeled 'Switch 1'. A vertical dashed line is drawn between Bulb A and Bulb B, indicating they are in parallel branches.</p>
38b	High melting point / conductor of electricity / good conductor of heat.
38c	If one of the heating elements is not working, the heating element in circuit Y will still work, as it is still a closed circuit and electricity can still pass through the other heating elements.
39a	By stroking the iron bar with a magnet in 1 direction and repeatedly.

39b	When the switch is closed, electricity flows through the close circuit. The electromagnet then attracts the clapper which hit the 'ding' plate. When the switch is opened, electricity stop flowing and the electromagnet will no longer attract the clapper. The clapper returns to its original position and hits the 'dong" plate.
39c	Add more batteries Or Add more coils (of wire) around the electromagnet.
40a	Kinetic energy $\rightarrow$ Kinetic energy + Gravitational Potential energy
40b	Fly lower. With the piece of plasticine attached, the toy will have more mass and more weight. Thus, the toy will fly lower.  Or Fly lower. With the piece of plasticine attached, the toy will have more mass and is harder / more difficult to fly against gravity. Thus, the toy will fly lower.

