

PSLE Index Number:

--	--	--	--	--	--	--



MARIS STELLA HIGH SCHOOL (PRIMARY)

PRELIMINARY EXAMINATION

22 August 2023

SCIENCE

(BOOKLET A)

Total Time for Booklets A and B: 1 hour 45 minutes

INSTRUCTIONS TO CANDIDATES

1. Do not turn over this page until you are told to do so.
 2. Follow all instructions carefully.
 3. Answer all questions.
 4. Shade your answers on the Optical Answer Sheet (OAS) provided.
-

Name: _____ ()

Class: 6 _____

For each question from 1 to 28, four options are given. One of them is the correct answer. Make your choice (1, 2, 3 or 4). Shade the correct oval (1, 2, 3 or 4) on the Optical Answer Sheet (OAS).
(28 x 2 marks)

1 The diagram below shows a mushroom.

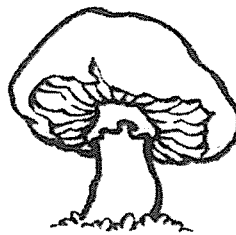

Which of the following characteristics confirms that the organism is a mushroom and not a plant?

- (1) It grows on land only.
- (2) It reproduces by spores.
- (3) It feeds on living or dead organisms.
- (4) It cannot move freely from one place to another.

2 A process during a stage in the life cycle of a bean plant is shown below.

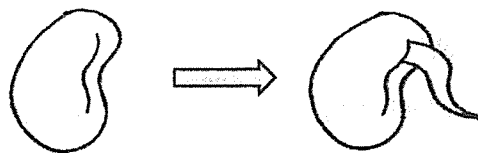

Which of the following correctly shows the conditions needed at this stage of the life cycle?

	Presence of light	Presence of water	Presence of warmth
(1)	yes	yes	yes
(2)	yes	yes	no
(3)	no	yes	yes
(4)	no	yes	no

- 3 The diagram below shows the processes involved in the reproduction of flowering plants.

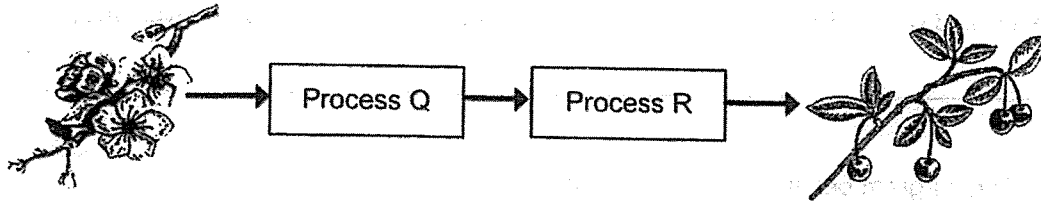

Which of the following correctly represents processes Q and R?

	Process Q	Process R
(1)	pollination	fertilisation
(2)	fertilisation	seed dispersal
(3)	germination	pollination
(4)	fertilisation	germination

- 4 The diagrams below show the male and female human reproductive systems.

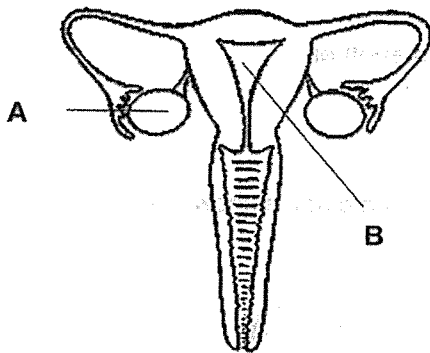

Female reproductive system

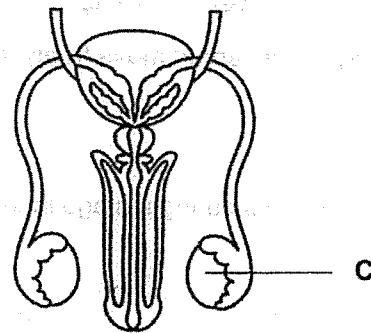

Male reproductive system

Which of the following correctly describes the functions of the parts labelled A, B and C?

	A	B	C
(1)	where the sperm and egg fuses	produces female reproductive cells	fuses with the female reproductive cells
(2)	produces female reproductive cells	where the fertilised egg develops	produces male reproductive cells
(3)	where the fertilised egg develops	produces female reproductive cells	where the sperm and egg fuses
(4)	releases fertilised eggs	where the sperm and egg fuses	produces male reproductive cells

5 Which of the following statements is/are true about sexual reproduction in both animals and flowering plants?

- X Pollination takes place before fertilisation.
- Y Fusion of sperm and egg results in a fertilised egg.
- Z Genetic information is passed down in the reproductive cells.

- (1) X only
- (2) Z only
- (3) Y and Z only
- (4) X, Y and Z

6 Andrew conducted an experiment in a dark room using the set-up below. He switched on the light source and observed the change in water level in the glass tube two hours later.

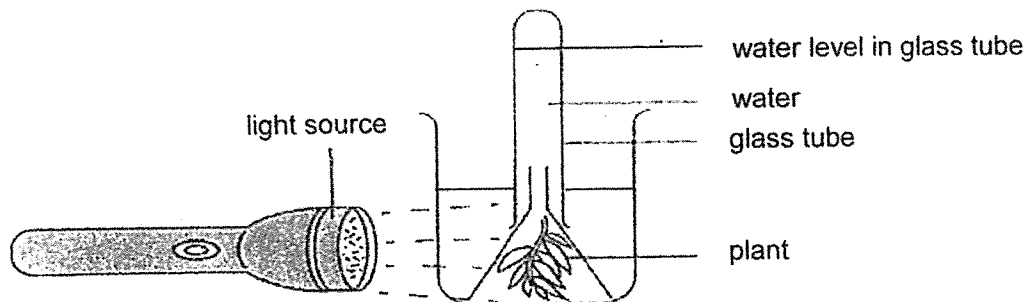

In which direction will the water level in the glass tube move and what is the reason for the movement after 2 hours?

	Direction of water level	Reason for the movement
(1)	↓	Oxygen is taken in by the plant.
(2)	↑	Water is given out by the plant.
(3)	↑	Carbon dioxide given out by the plant occupied the space.
(4)	↓	Oxygen produced by the plant occupied the space.

7 The diagram below is a food web

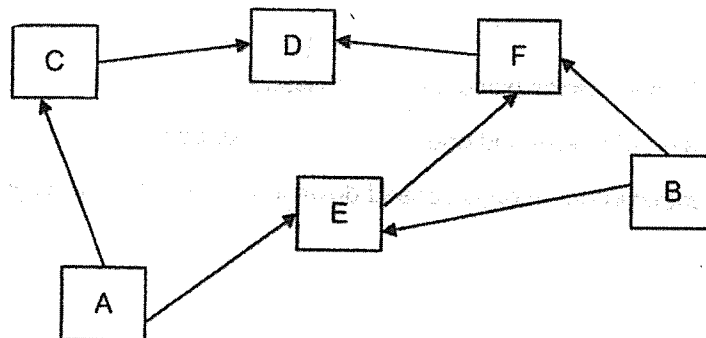

Based on the food web above, which of the following is correct?

	Prey	Both prey and predator	Predator
(1)	A, B	C, E	F, D
(2)	C, E	F	D
(3)	A, C	E, F	D
(4)	D	C, E, F	A, B

8 Brandon recorded the number of organisms he observed at a pond habitat in the table below

Organism	Number of organisms
dragonfly	2
frog	1
water lily	4
duck	2
dragonfly nymph	3
fish	5
cattail plant	8

Based on the table above, which of the following statements is correct?

- (1) There is 1 population of producer.
- (2) There are 3 populations of consumers.
- (3) There are 7 communities living in the pond.
- (4) There are 6 populations of living organisms.

- 9 Kenny studied some living organisms in a garden community. He found the following organisms:

mould, earthworm, mushroom, millipede, bacteria

Which of the classification is correct?

	Decomposers	Organisms that help the decomposers
(1)	earthworm, bacteria	mould, mushroom, millipede
(2)	mould, mushroom, bacteria	earthworm, millipede
(3)	millipede, earthworm	bacteria, mould, mushroom
(4)	earthworm, millipede, mushroom	mould, bacteria

- 10 Study the food web shown below.

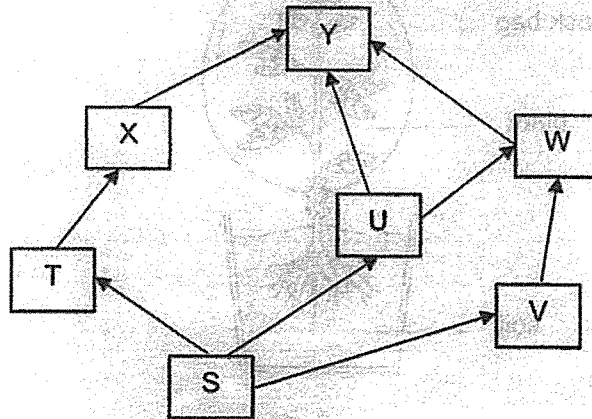

Which of the following could cause a decrease in the population of T?

- (1) A disease outbreak killing most of organism U.
- (2) A decrease in the reproduction rate of organism Y.
- (3) A large number of organism V moving to another habitat.
- (4) An introduction of predator of organism X into the habitat.

11 The diagram below shows three cells, X, Y and Z.

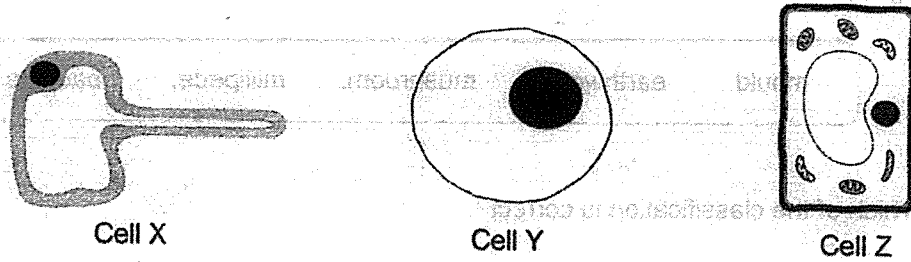

Which of the following statements is true?

- (1) Cell X and Z can make food.
- (2) Cell X and Y do not have fixed shapes.
- (3) Only cell Y has the cell part that can control all the activities in the cell.
- (4) Cell X, Y and Z have cell parts that control the substances that enter or exit the cell.

12 Carol tied a black bag around the leaves of a plant as shown. She watered the plant every day but the plant died after a few days.

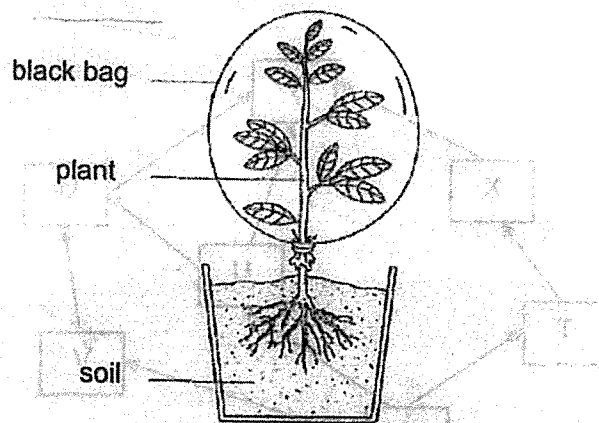

What could be a possible reason why the plant died after a few days?

- (1) The stem could not support the plant.
- (2) The leaves could not trap light to make food.
- (3) Water absorbed by the roots could not travel to the leaves.
- (4) Food made in the leaves could not travel to the rest of the plant.

- 13 The diagram below shows the blood flow in a human body.

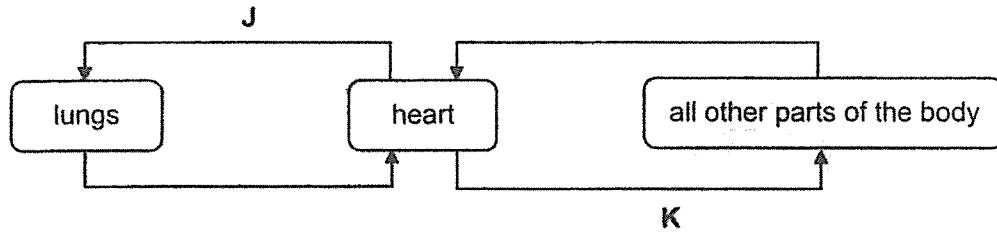

Which of the following is correct?

	Blood in J	Blood in K
(1)	poor in oxygen	poor in carbon dioxide
(2)	rich in oxygen	poor in carbon dioxide
(3)	poor in oxygen	rich in carbon dioxide
(4)	rich in oxygen	rich in carbon dioxide

- 14 Moth caterpillars feed on the leaves of trees, causing the trees to die over time. Some ways of getting rid of the moth caterpillars are spraying eco-friendly pesticides and cutting or burning down of the affected trees.

Based on the information provided, which of the following outcomes are likely to result over time?

- A Loss of habitats
- B Depletion of the ozone layer
- C Loss of aquatic life in the nearby rivers

- (1) A and B only
- (2) A and C only
- (3) B and C only
- (4) A, B and C

15 The diagrams below show a human circulatory system and a plant transport system.

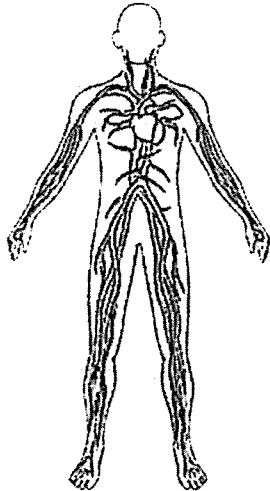

human circulatory system

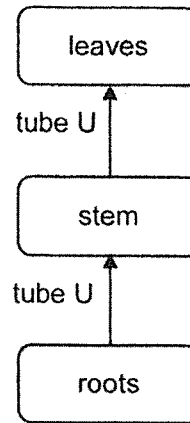

plant transport system

Which of the following is/are transported in both the human circulatory system and tube U of the plant transport system?

- A food
- B water
- C waste

- (1) A only
- (2) B only
- (3) A and B only
- (4) B and C only

16 Which of the following adaptations of the organism is correctly matched to its function?

	Organism	Adaptation feature	Function
(1)	penguin	flippers	To stay underwater
(2)	frog	webbed feet	To help it swim in water
(3)	camel	long legs	To walk long distances
(4)	polar bear	layer of fat	To float on water

17 Study the classification table below.

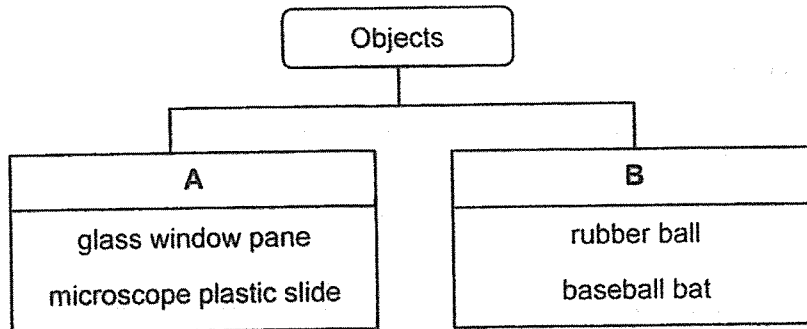

Which of the following best represents A and B?

	A	B
(1)	waterproof	not waterproof
(2)	sink in water	float on water
(3)	not flexible	flexible
(4)	allows light to pass through	do not allow light to pass through

18 Air is pumped into a balloon as shown below.

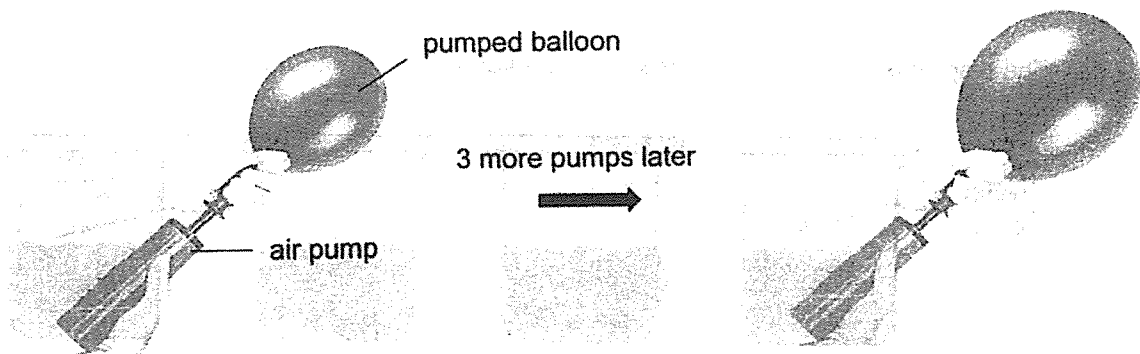

Which of the following correctly shows the changes in the total mass and volume of air in the balloon after 3 pumps of air?

	Total mass of air in the balloon	Total volume of air in the balloon
(1)	increases	increases
(2)	remains the same	increases
(3)	increases	remains the same
(4)	remains the same	remains the same

- 19 Rachel took some ice from the freezer and heated them in a container. She recorded the change in temperature over time as shown in the graph below.

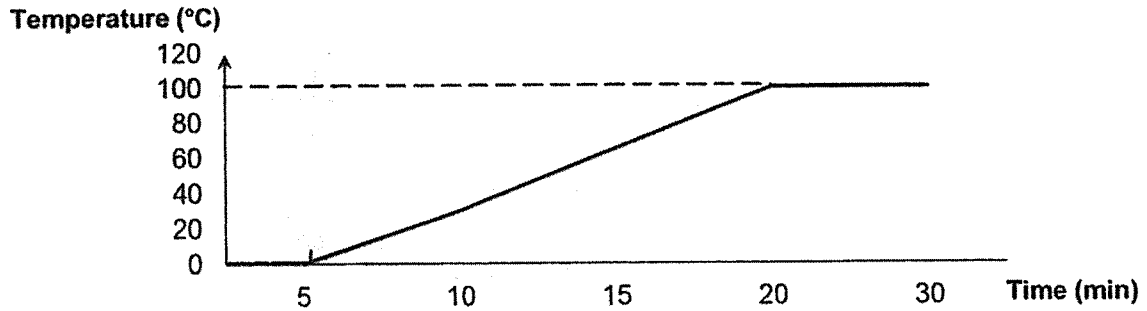

Based on the graph, which of the following statements is correct?

- (1) The ice took 5 minutes to melt completely.
 - (2) The water took 30 minutes to reach its boiling point.
 - (3) The heat source was removed from the container after 20 minutes.
 - (4) There was no heat gain after 20 minutes as the temperature remained constant.
- 20 Christina poured the same amount of water at different temperatures into four identical beakers, J, K, L and M. She then covered the beakers with identical lids and left them on a table in a room.

The diagrams below show Christina's observation after 5 minutes.

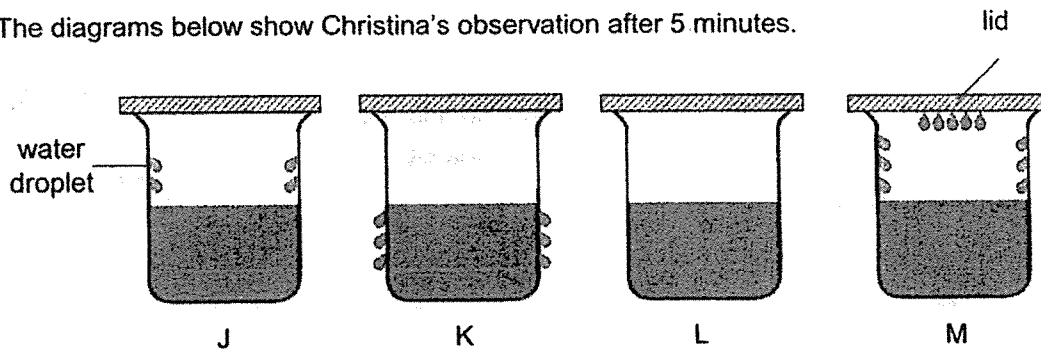

Which of the following shows the correct order of the temperature of water that was poured into the beakers, in increasing order?

- (1) M, K, J, L
- (2) K, J, L, M
- (3) M, J, L, K
- (4) K, L, J, M

21 Substance A is a solid at 60°C and a gas at 180°C.

Which of the following are possible melting and boiling points of A?

	Melting point of A (°C)	Boiling point of A (°C)
(1)	40	120
(2)	70	100
(3)	95	200
(4)	30	250

22 Irene released a wooden block from the top of a ramp as shown. The wooden block slid down the ramp and moved along the floor before stopping at point S.

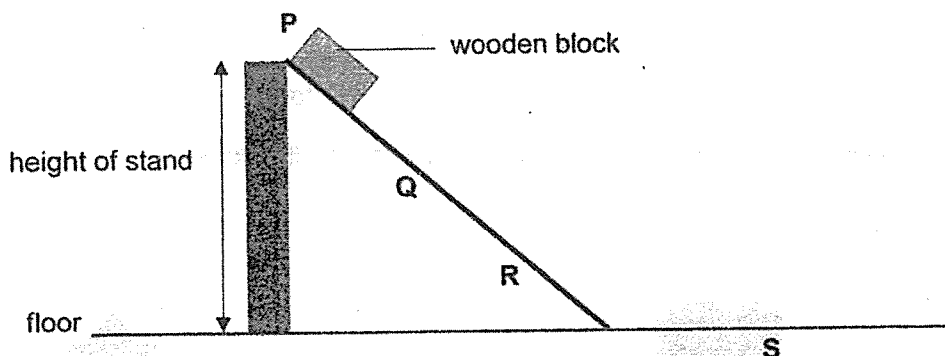

Which of the following statements are true about the wooden block?

- A The wooden block has the most potential energy at P.
- B The wooden block only had kinetic energy at Q and R.
- C The wooden block has more potential energy at R than at Q.
- D If lubricant is applied on the floor, the wooden block would slide beyond S.

- (1) A and B only
- (2) C and D only
- (3) A and D only
- (4) A, B, C and D

23 The diagrams below shows three paper cut-outs, X, Y and Z.

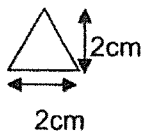

X

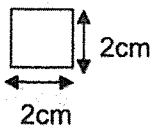

Y

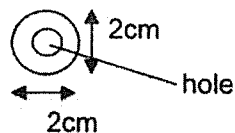

Z

The three cut-outs were used to cast a shadow on a screen as show below.

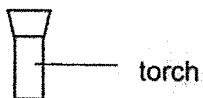
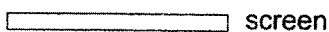

Which of the following shows the shadow cast on the screen?

(1)



(2)



(3)



(4)

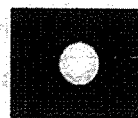

24 The diagram below shows a pendulum swinging from A to C.

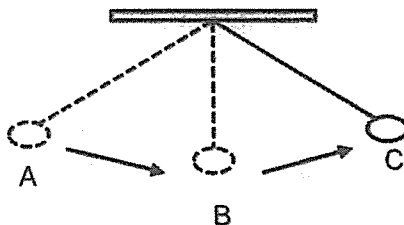

Which of the following correctly shows the energy changes as the pendulum swings from A to C?

	Amount of potential energy from A to B	Amount of kinetic energy from B to C
(1)	increase	decrease
(2)	increase	increase
(3)	decrease	decrease
(4)	decrease	increase

25 Mark set up an experiment using three bar magnets as shown.

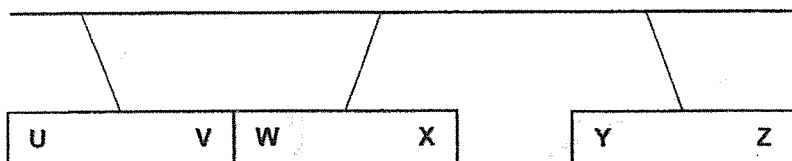

Using the observation above, he further predicted the interactions between the poles of the three bar magnets if they were brought near one another.

His predictions are recorded in the table below.

Prediction	Poles of magnets	Interaction
A	V and Y	repel
B	U and X	attract
C	W and Z	attract
D	V and X	repel

Which of the following predictions made by Mark are correct?

- (1) A and B only
- (2) B and C only
- (3) A, B and D only
- (4) B, C and D only

- 26 Raymond set up an experiment using two cups, X and Y, of the same size and thickness, made of metal and plastic respectively. He filled each cup with an equal amount of water at a temperature of 28°C . He recorded the temperature of water over three hours.

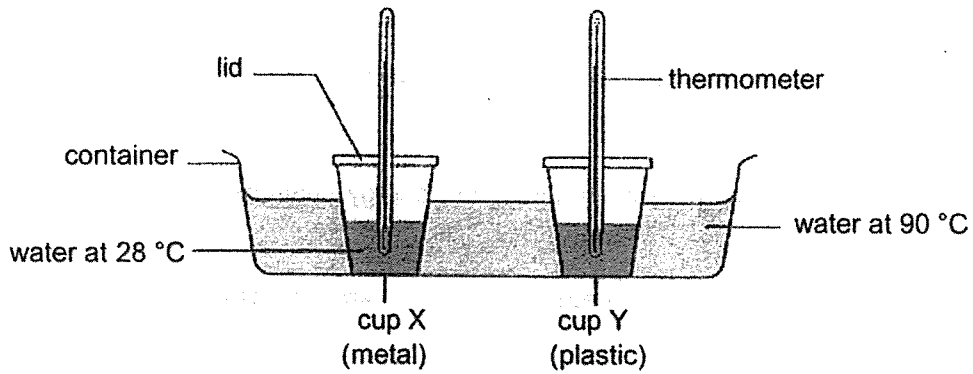

Which of the following graphs correctly shows the temperature of water in the cups?

(1)

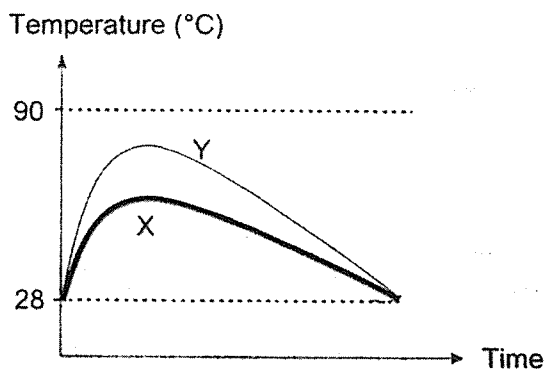

(2)

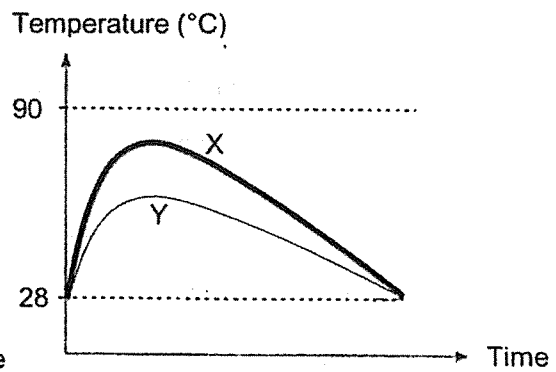

(3)

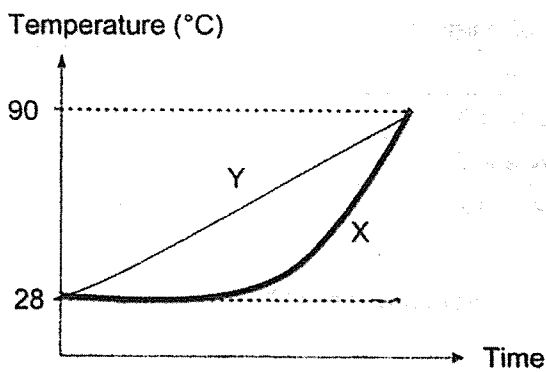

(4)

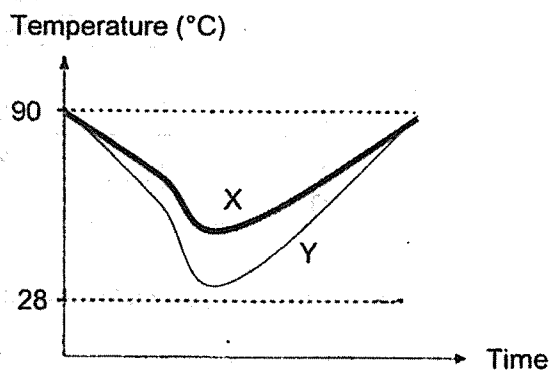

- 27 Diagram 1 shows the length of a spring when magnet A is hung on it. Diagram 2 shows the length of spring when magnet B is placed below magnet A. The original length of the spring when no mass is hung on it is 11 cm.

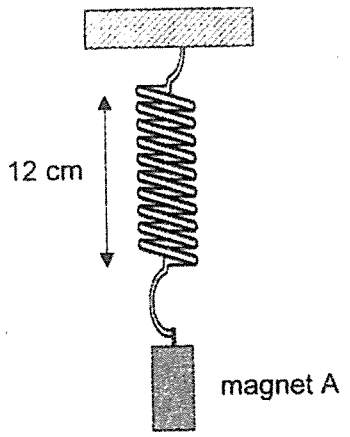

Diagram 1

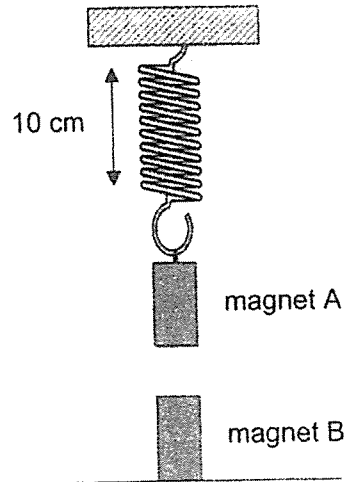
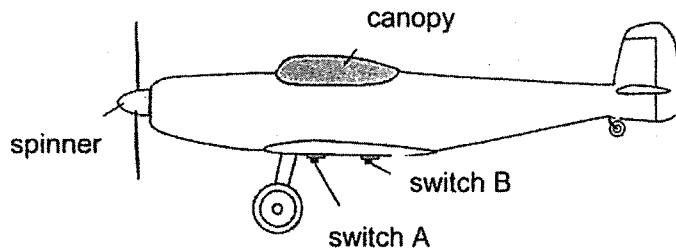

Diagram 2

Which of the following shows the correct direction of the different types of forces acting on the magnets in Diagram 2?

	Magnetic force acting on magnet A	Gravitational force acting on magnet B	Elastic spring force acting on magnet A
(1)	↑	↓	↓
(2)	↑	↑	↓
(3)	↑	↓	↑
(4)	↓	↑	↑

28 Omar has a toy aeroplane that works on batteries.



His observations are shown below.

Switched ON	Observations
both A and B	<ul style="list-style-type: none"> Spinner turned. Canopy lit up.
A only	<ul style="list-style-type: none"> Spinner turned. Canopy did not light up.
B only	<ul style="list-style-type: none"> Spinner did not turn. Canopy lit up.

Which of the following correctly shows the electrical circuit in the toy aeroplane?

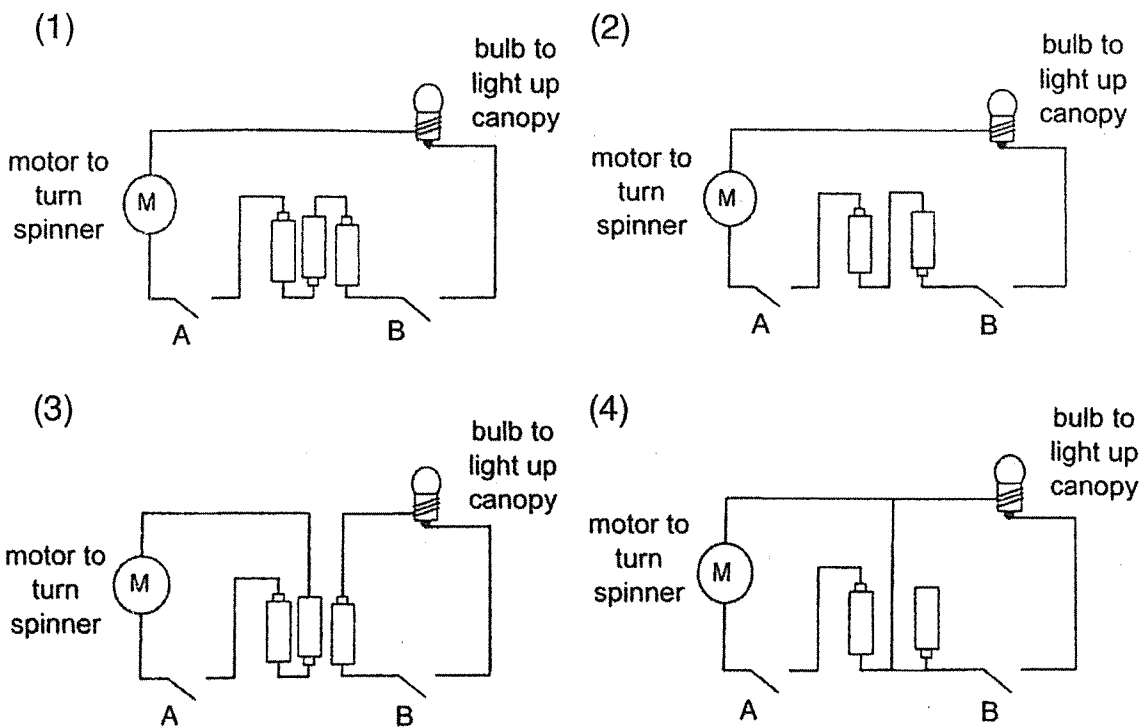

END OF BOOKLET A

PSLE Index Number:

--	--	--	--	--	--	--



MARIS STELLA HIGH SCHOOL (PRIMARY)

PRELIMINARY EXAMINATION

22 August 2023

SCIENCE

(BOOKLET B)

Total Time for Booklets A and B: 1 hour 45 minutes

INSTRUCTIONS TO CANDIDATES

1. Do not turn over this page until you are told to do so.
2. Follow all instructions carefully.
3. Answer all questions.
4. Use a dark blue or black ballpoint pen to write your answers in the space provided for each question.
5. Do not use correction fluid/tape or highlighters.

Booklet A: _____ / 56

Booklet B: _____ / 44

Parent's Signature: _____

Name: _____ ()

Class: 6 _____

For questions 29 to 40, write your answers in this booklet. The number of marks available is shown in brackets [] at the end of each question or part question. (44 marks)

29 The diagram below shows the life cycle of a frog.

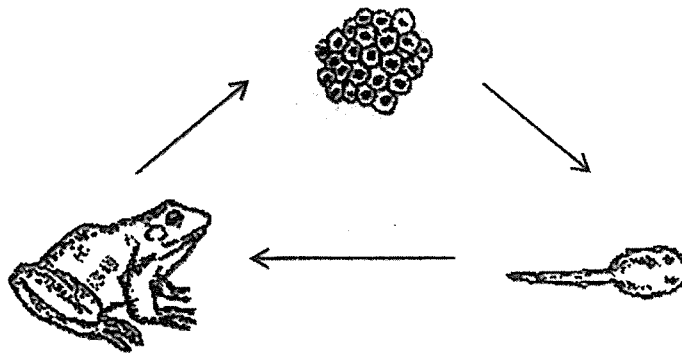

(a) Explain how laying many eggs at one time can help in the survival of the frog. [1]

The young of a frog lives in water while the adult frog can live on land and in water.

(b) Suggest two advantages for the young and the adult to live in different environments. [2]

Advantage 1: _____

Advantage 2: _____

30 Mei Na placed a bag in each of the beakers, A and B, which contained liquid X and Y respectively as shown. The bag was made of a special material and contained liquid Z.

The levels of liquid in the tubes were the same at the start of the experiment. Mei Na observed the change in the level of liquid in the tubes after one hour.

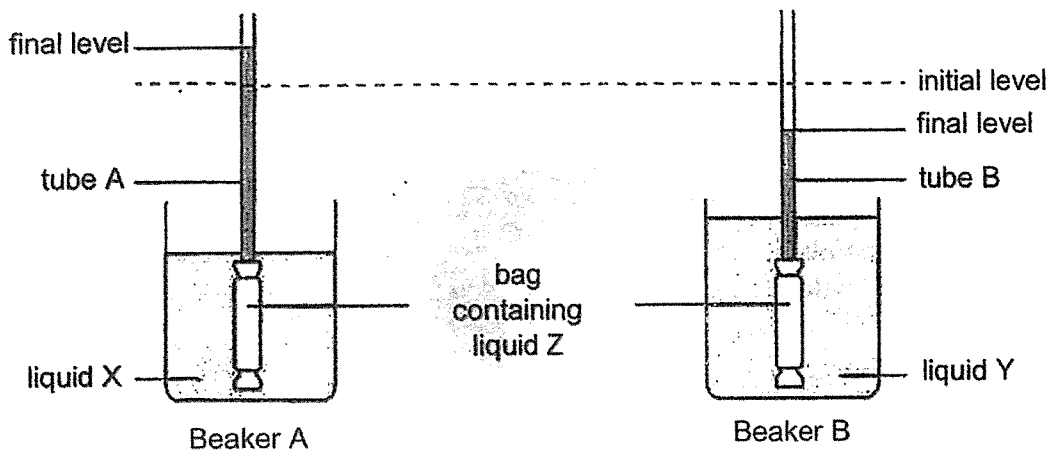

(a) Explain why the level of liquid in tube A increased but the level of liquid in tube B decreased.

Two cells, P and Q, are shown below.

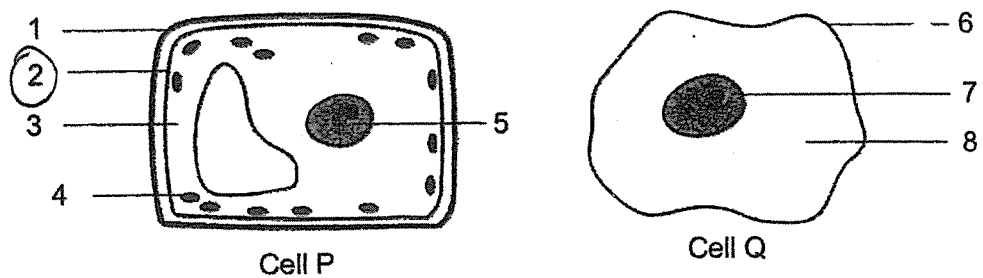

(b) State the parts (1 to 8) which function similar to the bag made of special material. [1]

	2
--	---

- 31 The diagram shows insect K and flower P. Only insect K knows how to enter flower P to obtain nectar. When insect K lands on flower P, it steps on the side petals and exposes the inside of the petals.

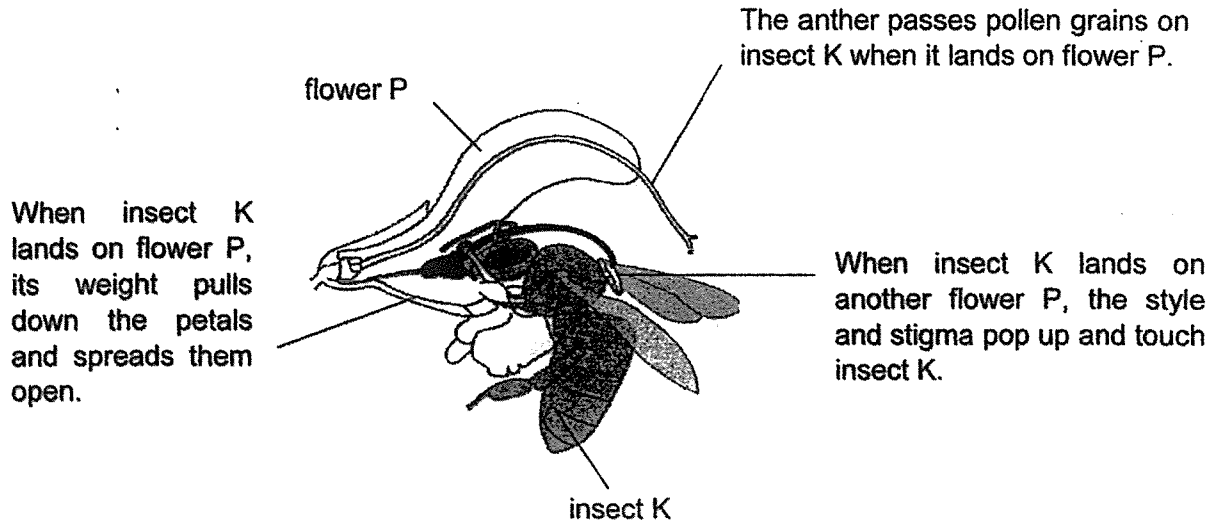

- (a) When another insect lands on flower P, the petals do not spread open. Suggest a possible reason why this is so. [1]

- (b) State one advantage to insect K being the only type of insect to pollinate flower P. [1]

Flower T looks like flower P but has no nectar.

- (c) Explain how looking like flower P is an advantage to flower T. [1]

The forested area where insect K lives in is being cleared for building of roads.

- (d) Explain how clearing of the forested area affects the population of insect K. [1]

- (e) Deforestation can also lead to global warming. Give a reason why that is so. [1]

	2
--	---

32 Eileen observed that plants X and Y are growing in the same pond.

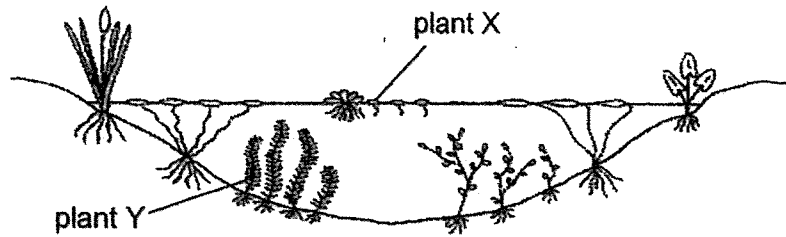

She wanted to find out if a change in the population of X would affect the population of Y. Three set-ups, E, F and G, in identical glass containers, were put at a well-lit place for a week.

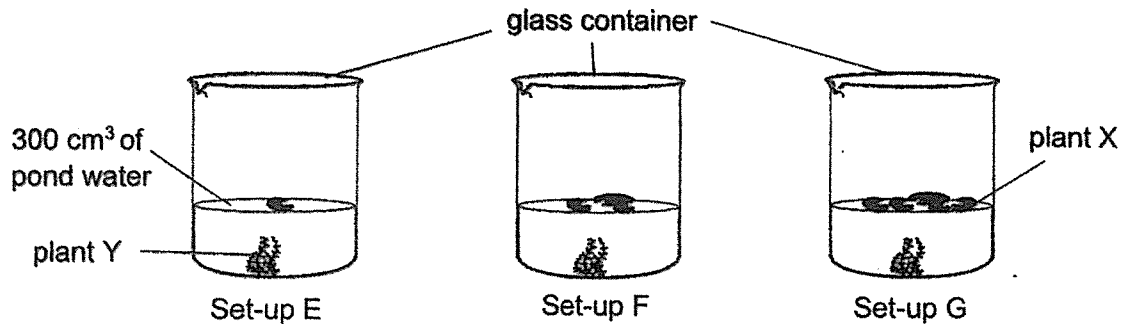

(a) Suggest a hypothesis for her experiment. [1]

Her teacher told her that an environmental factor of her set-up was affecting the validity of her results.

(b) Suggest one change Eileen could make to her set-ups so that she can obtain valid results. [1]

(c) Besides repeating her experiment a few more times, suggest another method Eileen could use to obtain more reliable results. [1]

- 33 The graph below shows the relationship between the size of a person's lungs and the amount of air the lungs can hold.

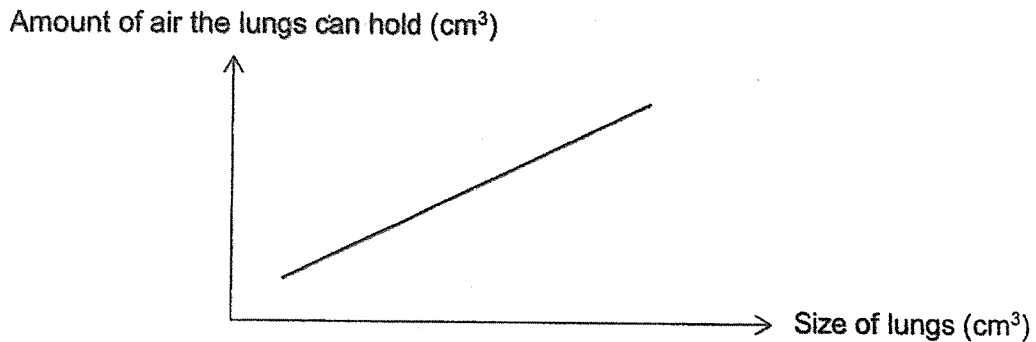

- (a) Based on the graph, state how the size of a person's lungs affects how much air the lungs can hold. [1]

Mr Tan had a bacterial infection which affected his lungs. The infection caused his lungs to be filled with fluid. As a result, his breathing rate was affected as shown in the table below.

	Breathing rate per min
Before getting bacterial infection	16
After getting bacterial infection	27

- (b) Describe the change in Mr Tan's breathing rate after getting the bacterial infection and explain why. [2]

The doctor also noticed that Mr Tan's heart rate had increased due to the lung infection.

- (c) Explain how the increase in his heart rate helps Mr Tan to survive. [1]

- 34 Kevin placed a piece of dry cotton wool inside a clear plastic cup. He then inverted the cup and pushed it vertically down into a container of water. He noticed bubbles escaping from the plastic cup as water entered the cup. The piece of cotton wool then became wet.

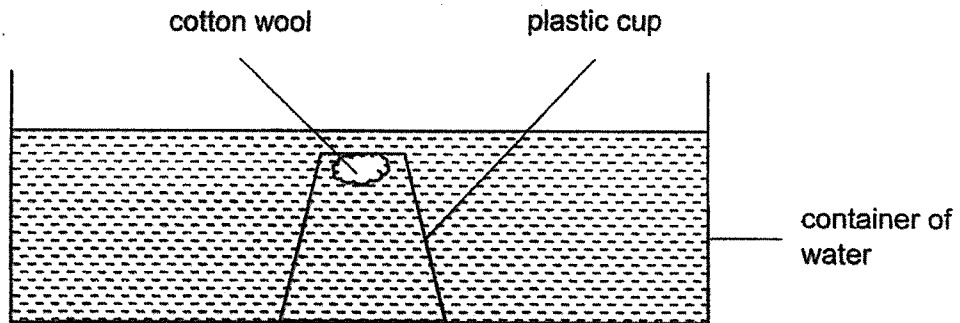

His teacher told him that the piece of cotton wool should remain dry and he wondered what had gone wrong with his experimental set-up.

- (a) Suggest a possible explanation for what had caused the cotton wool to be wet. [2]

Kevin repeated his experiment using a new plastic cup and an identical piece of dry cotton wool.

- (b) Draw the water level in the plastic cup to show how the set-up should look like in order for the cotton wool to remain dry. [1]

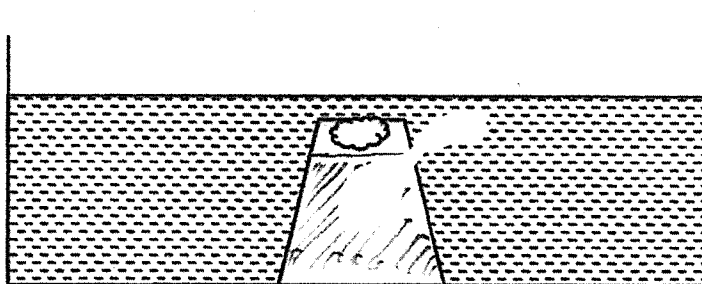

35 The diagram below shows a water splash bucket S at an indoor water playground.

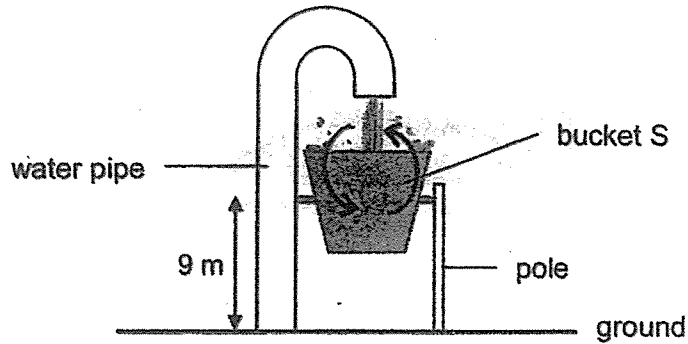

The bucket is able to rotate about the pole attached to it. The bucket will tip over and empty the water onto the ground when it is fully filled with water.

- (a) Fill in the boxes to show the main conversion of energy that takes place in the water when the fully-filled water bucket tips over. [1]

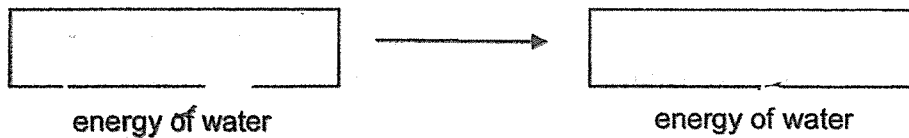

A similar water splash bucket T which was smaller and could hold less water was found at another corner of the same playground.

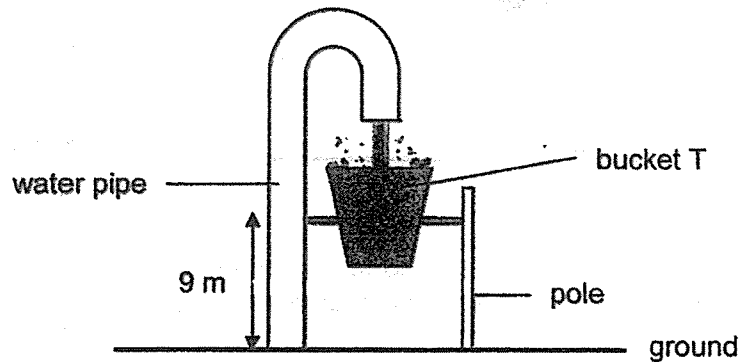

- (b) In which water bucket, S or T, would the water create a greater impact on the ground when tipped over? Explain your choice. [2]

	3
--	---

- 36 Stanley placed some crushed ice on a metal tray and left the tray on the table. After a few seconds, he noticed some white mist appearing above the crushed ice.

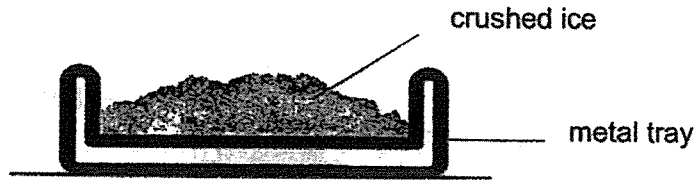

- (a) Explain how the white mist was formed. [2]

Stanley conducted an experiment using the set-ups below. He placed the same amount of crushed ice in each funnel. He then added 50 g of salt to the crushed ice in set-up B.

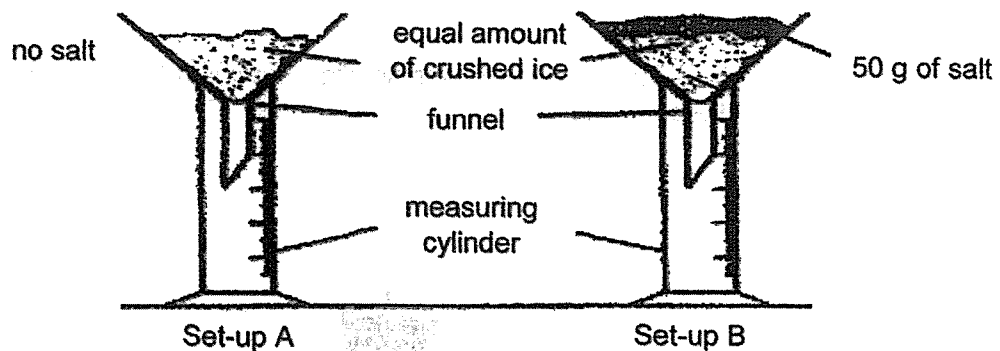

The crushed ice in both set-ups started to melt. He measured the volume of water collected in each cylinder after 20 minutes. The results are recorded and shown in the graph below.

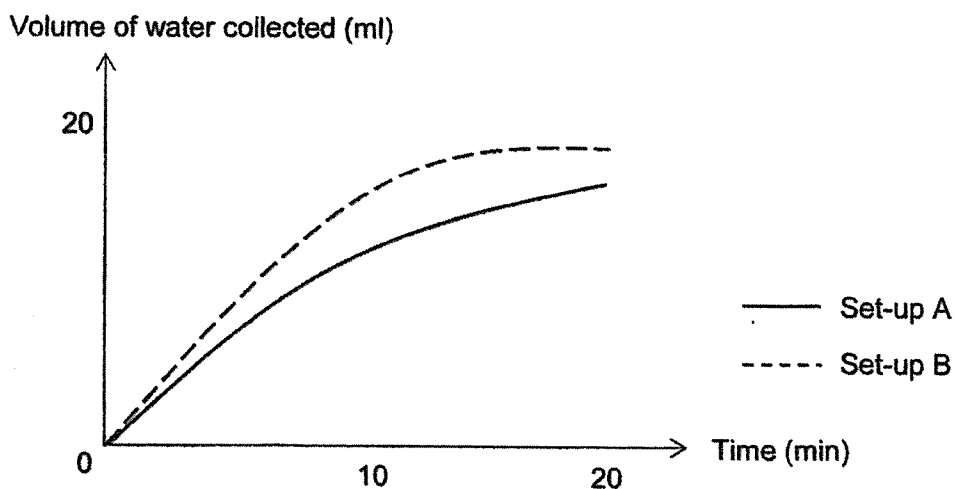

	2
--	---

(b) What variable did Stanley change in his experiment?

[1]

(c) Based on the graph, state the effect of salt added to the crushed ice on the volume of water collected.

During winter, roads filled with snow make it slippery and dangerous for drivers. People will scatter salt on the roads to overcome this problem.

(d) Based on the observation from the experiment, explain how scattering salt is effective in making roads safer for drivers during winter. [1]

37 The set-up below is installed at a walkway to track the number of people using the walkway.

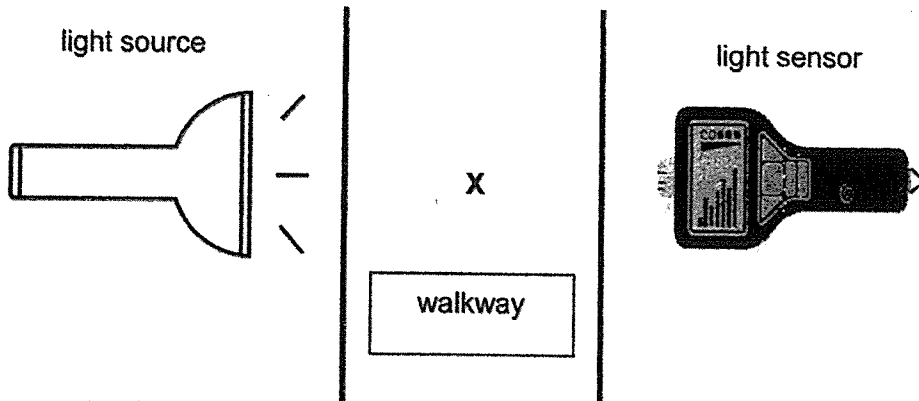

The table below shows the readings recorded by the light sensor when the set-up is turned on.

	Amount of light detected (units)
When someone walks past the sensor at X	K
When no one walks past the sensor at X	500

(a) What is the value of K? Circle the correct answer. [1]

0 / 500 / 800

(b) Explain how the set-up is able to track the number of people using the walkway. [2]

38 Johnson ordered a cold drink as shown below. He noticed that an empty chilled mug taken from the freezer was used to fill the 15°C cold drink he ordered.

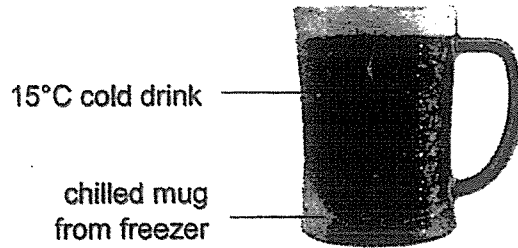

- (a) Explain how pouring a 15°C cold drink into a chilled mug helps to make the drink colder as compared to pouring the same drink into a mug at room temperature. [2]

Two cups, X and Y, are shown. Cup X is a double-walled glass cup with a layer of air in between two glass walls while cup Y only has a single glass wall.

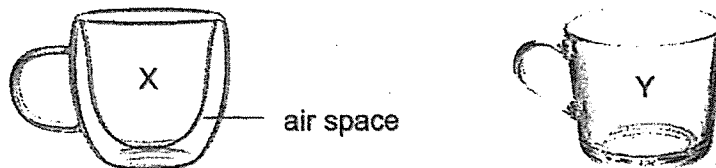

- (b) How does using cup X help to keep cold drinks cool for a longer period of time? [1]

- (c) Will there be *more, less or the same amount* of water droplets formed on the outside of the cup X as compared to cup Y when cold water is poured into the cups? Explain your answer. [2]

- 39 The diagram shows Jason jumping on a trampoline. He reached a higher position with each jump. As he landed on the jumping mat, the mat dipped lower each time and the springs attached to the jumping mat stretched further.

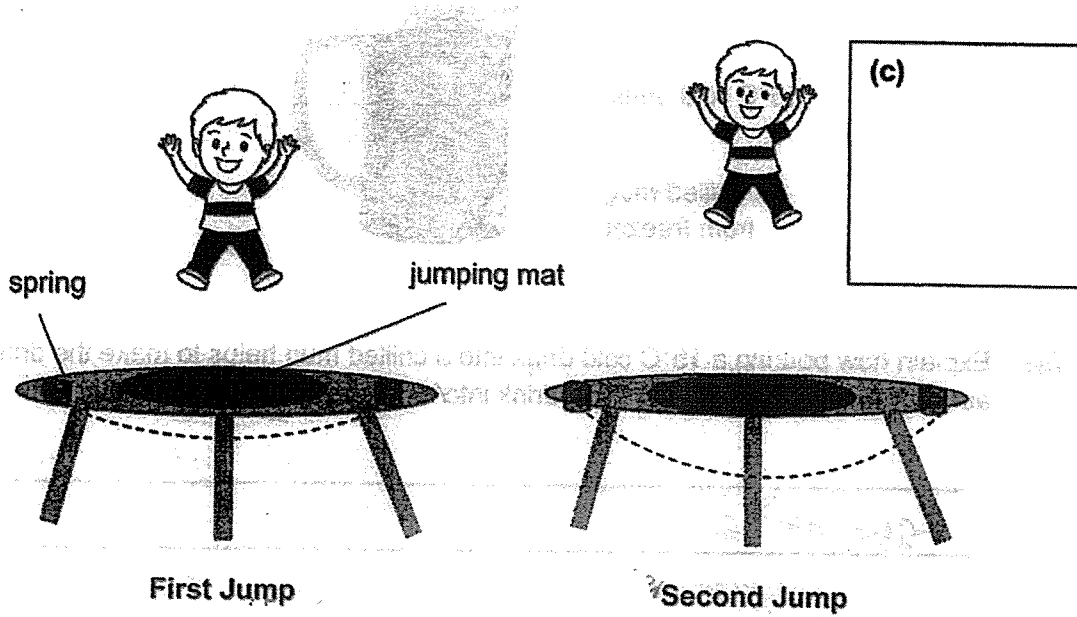

- (a) Why was Jason able to jump higher on the trampoline during his second jump? Explain your answer in terms of forces. [1]

The bar graph shows the amount of gravitational force acting on Jason during his first jump.

- (b) Complete the bar graph below to show the amount of gravitational force acting on Jason during his second jump. [1]

Gravitational force (units)

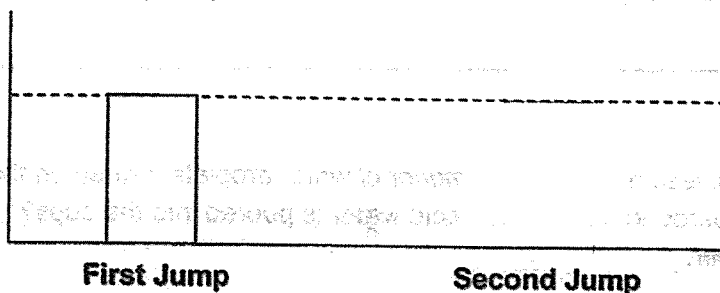

- (c) Indicate the direction of frictional force acting on Jason when he is jumping upwards by drawing an arrow (\longrightarrow) in the box provided. [1]

	3
--	---

- 40 An engineer designed the set-up below to help the airport personnel check the mass of a baggage at the check-in counter. Each baggage allowance is 30 kg. When the baggage weighs more than 30 kg, the bell will ring.

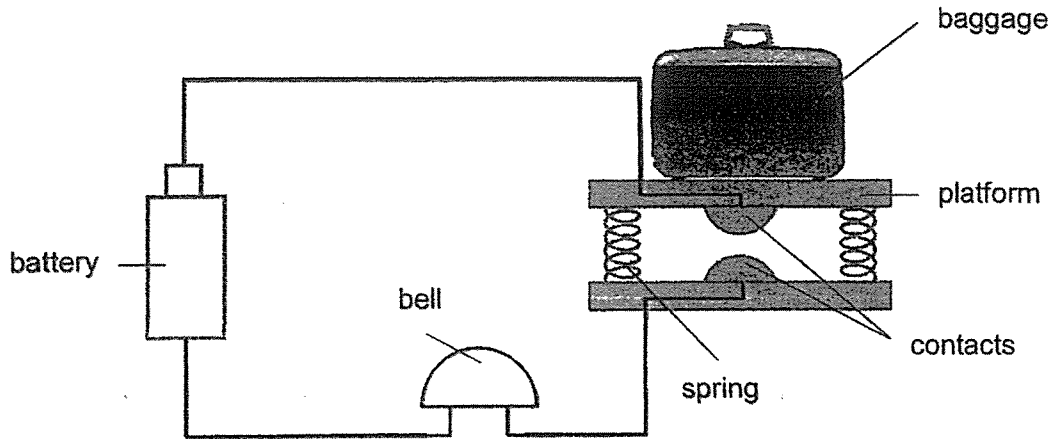

- (a) State the forces that are present in the set-up above. [1]

- (b) What property must the contacts possess in order for the set-up to work? [1]

- (c) Explain how the bell would ring when a 32 kg baggage is placed on the platform. [2]

The engineer wants to make a change to his set-up so that the bell will ring when the baggage weighs more than ~~40~~ kg.

- (d) Suggest one change he can make to his set-up. [1]

SCHOOL : MARIS STELLAR PRIMARY SCHOOL
LEVEL : PRIMARY 6
SUBJECT : SCIENCE
TERM : 2023 PRELIMINARY EXAMINATION

SECTION A

Q1	Q2	Q3	Q4	Q5	Q6	Q7	Q8	Q9	Q10
3	3	1	4	2	4	2	2	2	2
Q11	Q12	Q13	Q14	Q15	Q16	Q17	Q18	Q19	Q20
4	2	1	2	2	2	4	1	1	4
Q21	Q22	Q23	Q24	Q25	Q26	Q27	Q28		
2	3	1	3	3	2	1	3		

SECTION B

Q29a	Laying many eggs at one time make it so that at least some eggs will not be eaten by predators. To hatch and grow into an adult to reproduce ensuring the continuity of its kind.
Q29b	There will not be competition for food between the young and the adult. When one environment becomes unfavourable, the other stage of the frog can still survive.
Q30a	Liquid X entered the bag in A and Liquid Z exit the bag in B
Q30b	2 and 6
Q31a	One possible reason is that the insect is too light.
Q31b	Insect K faces less competition for food.
Q31c	Insect K might mistaken Flower T for P and pollinate, increasing the chances of pollination for Flower T.

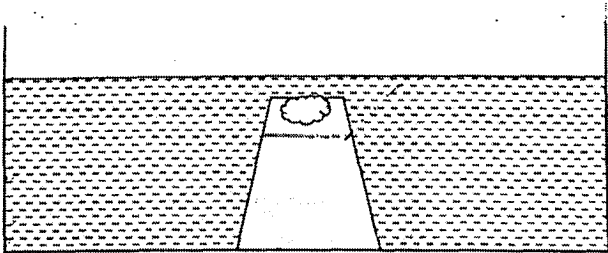
Q31d)	This results in loss of habitat for K, allowing predators to spot K easily, decreasing the population of K
Q31e)	When trees are cut down, there is lesser trees to take in carbon dioxide, greenhouse gas for photosynthesis, causing more heat from the sun to be trapped, leading to global warming.
Q32a)	As the population of X increases, population of X decreases.
Q32b)	Change all glass containers to opaque
Q32c)	Have multiple setup of E,F &G
Q33a)	As the size of the lungs increases, the amount of air the lungs can hold increases.
Q33b)	Mr Tan breathed faster after the bacterial infection. When Mr Tan's lungs are filled with fluid, there is lesser space for air in the lungs can hold, so Mr Tan breathes faster to take in enough air for respiration to release energy and carbon dioxide.
Q33c)	Heart needs to pump faster to transport blood rich in digested food to all parts to supply enough energy for his body
Q34a)	There might be a hole in the cup so there was no air left in the cup as it has escaped, so the cotton wool absorbed the water in the cup, causing the cotton wool to be wet
Q34b)	
Q35a)	Gravitational potential – Kinetic
Q35b)	Bucket S could hold more water than T so the mass of the water in S would be higher and possess more gravitational potential energy, which converts to more kinetic energy of the water when it hits the ground, causing the impact to be greater

Q36a)	Warmer water vapour from the surrounding air comes into contact with the air just above the crushed ice, loses heat to it and condenses to form tiny water droplets which was observed in the mist.
Q36b)	The presence of salt.
Q36c)	Presence of salt increases volume of water collected
Q36d)	When salt is scattered on the roads, the snow will melt faster to form water, making it less slippery and dangerous for drivers.
Q37a)	0
Q37b)	When one person walks past the light sensor, the light detected drops to zero, so each time the light detected drops to zero, means one person used the walkway. Count the number of times the sensor detects no light.
Q38a)	Pouring a 15°C drink into a chilled mug cools it faster than pouring it into a room temperature mug because the chilled mug absorbs heat more quickly due to the larger temperature difference, helping the drink reach a colder temperature.
Q38b)	X has a layer of air in the cup as air is a poor conductor of heat, the cold drink gains heat slower from the surrounding air, keeping it cooler for a longer period of time.
Q38c)	Less as Y has no layer of air, Y will lose heat to the cold water faster than X, causing it to be cooler, so when warmer water vapour from the surrounding air comes into contact with Y, it loses heat to Y faster to condense faster and form more water droplets.
Q39a)	On the second jump, Jason presses more elastic spring force, allowing him to jump higher.
Q39b)	<p>Gravitational force (units)</p> <p>First Jump Second Jump</p>

Q39c)	
Q40a)	Elastic spring force, gravitational force and frictional force
Q40b)	It must be a conductor of electricity
Q40c)	When a baggage of 32kg is placed on the platform, the 4 step contacts will touch, forming a closed circuit. Electrical current can then flow through the bell, causing it to ring.
Q40d)	He can make the springs stiffer such that when a baggage of 40kg is placed on the platform, the contacts will touch.

