

Name: _____ ()

Class: Primary 6 _____

CHIJ ST NICHOLAS GIRLS' SCHOOL (PRIMARY)

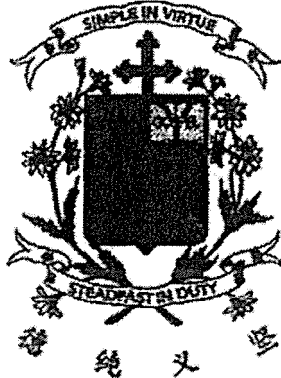

Primary 6 Mathematics

2022 Preliminary Examination

Paper 1

Booklet A

22 August 2022

15 questions
20 marks

Total Time for Booklets A and B: 1 hour

INSTRUCTIONS TO CANDIDATES

Do not turn over this page until you are told to do so.
Follow all instructions carefully.
Answer all questions.
Write your answers in this booklet.
The use of calculators is **NOT** allowed.

This booklet consists of 11 printed pages.

Questions 1 to 10 carry 1 mark each. Questions 11 to 15 carry 2 marks each. For each question, four options are given. One of them is the correct answer. Make your choice (1, 2, 3 or 4). Shade the correct oval (1, 2, 3, or 4) on the Optical Answer Sheet.

(20 marks)

1. What is the value of 4 hundreds, 9 tenths and 7 hundredths?

- (1) 409.7
- (2) 409.07
- (3) 400.907
- (4) 400.97

2. Find the value of $35 - 5 \times 3 + 48 \div 6$.

- (1) 23
- (2) 28
- (3) 38
- (4) 98

3. There were 16 chairs in a room at first. Another 4 chairs were put in the room. Find the percentage increase in the number of chairs in the room.

- (1) 20%
- (2) 25%
- (3) 75%
- (4) 80%

4. Which of the following is the same as 20 km 57 m?

- (1) 2057 m
- (2) 2570 m
- (3) 20 057 m
- (4) 20 570 m

5. What is 45 minutes before the time shown on the clock?

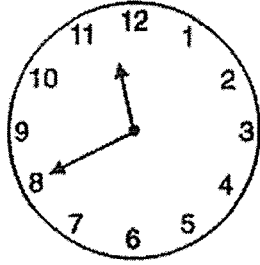

- (1) 19 15
- (2) 20 45
- (3) 22 55
- (4) 23 40

6. Which triangles, A, B, C and D have the same area?

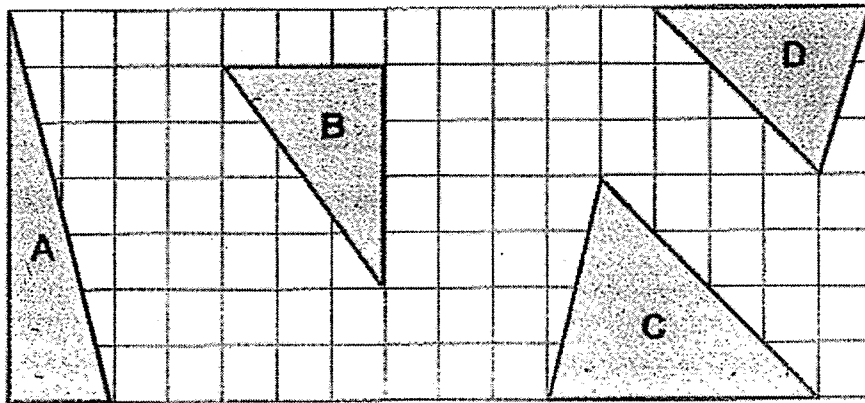

- (1) A and B
- (2) B and C
- (3) B and D
- (4) C and D

7. The figure below shows a pyramid.

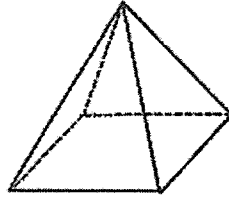

Which of the following nets **cannot** be folded to form the pyramid?

(1)

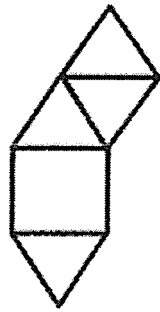

(2)

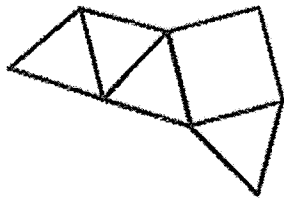

(3)

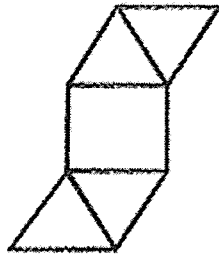

(4)

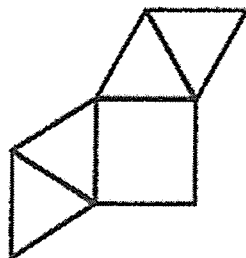

8. In the figure, PQRS is a square. RST is an equilateral triangle. QUS is a straight line. Find $\angle QUR$.

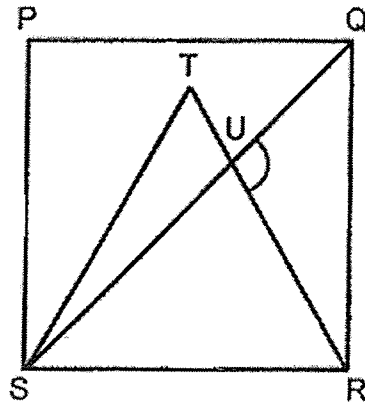

- (1) 135°
(2) 105°
(3) 75°
(4) 60°
9. Wynona wrote the numbers below :

20 , 15 , 15 , 0 , 10

What is the average of all the numbers?

- (1) 9
(2) 12
(3) 15
(4) 60

10. The pie chart shows the amount of money collected by a bakery in a day.
How much money was collected from the sale of muffins?

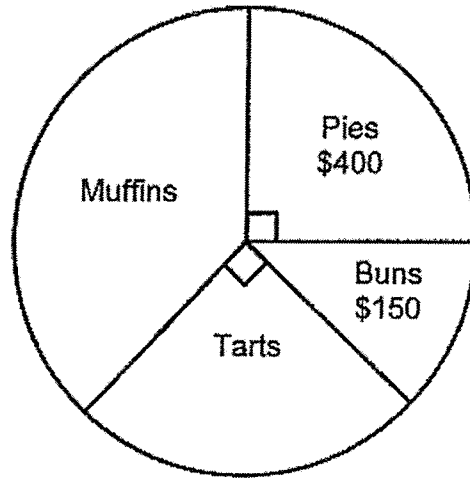

- (1) \$250
- (2) \$550
- (3) \$650
- (4) \$950

11. The table shows the number of badges three girls had at first.

Name	Number of badges
Skyla	36
Noemi	21
Goldie	?

Skyla and Noemi each gave Goldie the same number of badges. Then Skyla and Goldie had 26 badges each. How many badges did Goldie have at first?

- (1) 5
 - (2) 2
 - (3) 6
 - (4) 4
12. Joel packed 36 English books and 54 Chinese books into as many bags as possible, with no remainder. He placed the same number of books in each bag. The number of English books in each bag was the same. How many English books did he pack into each bag?

- (1) 18
- (2) 2
- (3) 3
- (4) 4

13. A semicircle with a diameter of 21 cm is cut out from a square piece of cardboard.
What is the perimeter of the remaining piece of cardboard? (Take $\pi = \frac{22}{7}$)

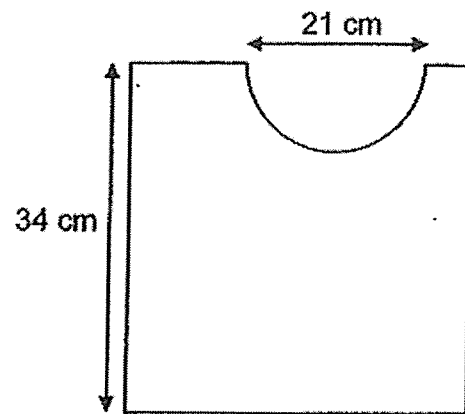

- (1) 168 cm
- (2) 157 cm
- (3) 148 cm
- (4) 135 cm

14. Which one of the following statements is TRUE of the diagram shown?

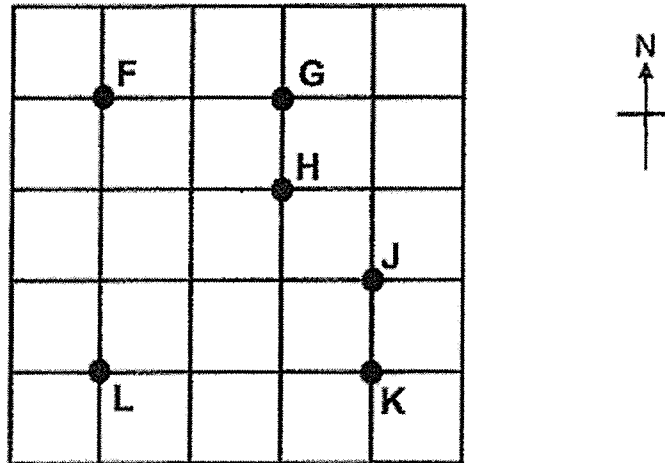

- (1) Point G is north-east of Point L.
- (2) Point G is north-west of Point K.
- (3) Point H is south-west of Point L.
- (4) Point K is south-east of Point F.

15. Levene gave $\frac{1}{5}$ of her balloons to Brissa. She also gave Odette 10 fewer balloons than Brissa. In the end, Levene had 82 balloons. How many balloons did Levene give away altogether?

- (1) 33
- (2) 38
- (3) 115
- (4) 120

Name: _____ ()

Class: Primary 6 _____

CHIJ ST NICHOLAS GIRLS' SCHOOL (PRIMARY)



**Primary 6 Mathematics
2022 Preliminary Examination**

Paper 1

Booklet B

22 August 2022

Booklet A	20
Booklet B	25
Total (Paper 1)	45

15 questions
25 marks

Total Time for Booklets A and B: 1 hour

INSTRUCTIONS TO CANDIDATES

Do not turn over this page until you are told to do so.
Follow all instructions carefully.
Answer all questions.
Write your answers in this booklet.
The use of calculators is **NOT** allowed.

This booklet consists of 11 printed pages.

Questions 16 to 20 carry 1 mark each. Show your working clearly and write your answers in the spaces provided. For questions which require units, give your answers in the units stated. (5 marks)

Do not write in this space

16. Write a decimal that is between 8.4 and 8.5

Ans: _____

17. Arrange the following from the greatest to the smallest.

$$1\frac{9}{10}, \quad \frac{14}{5}, \quad \frac{9}{6}, \quad 2$$

Ans: _____

18. Express 0.1% as a fraction.

Ans: _____

--

19. What is the mass of the bag of onions?

Do not
write
in this
space

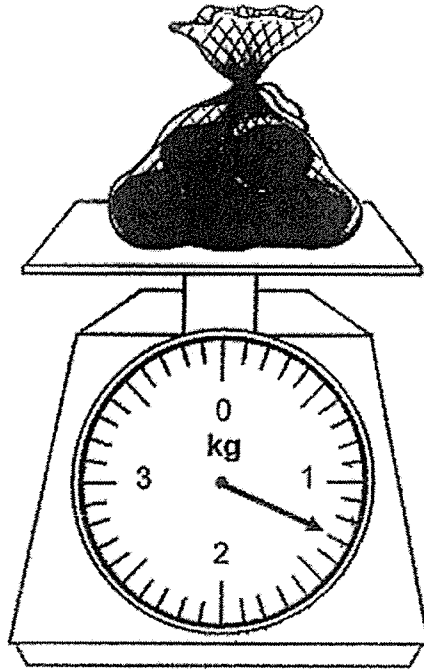

Ans: _____ kg

20. Kailli took part in a cycling race. The line graph shows the total distance she cycled from 7 a.m. to 9 a.m.

Do not write in this space

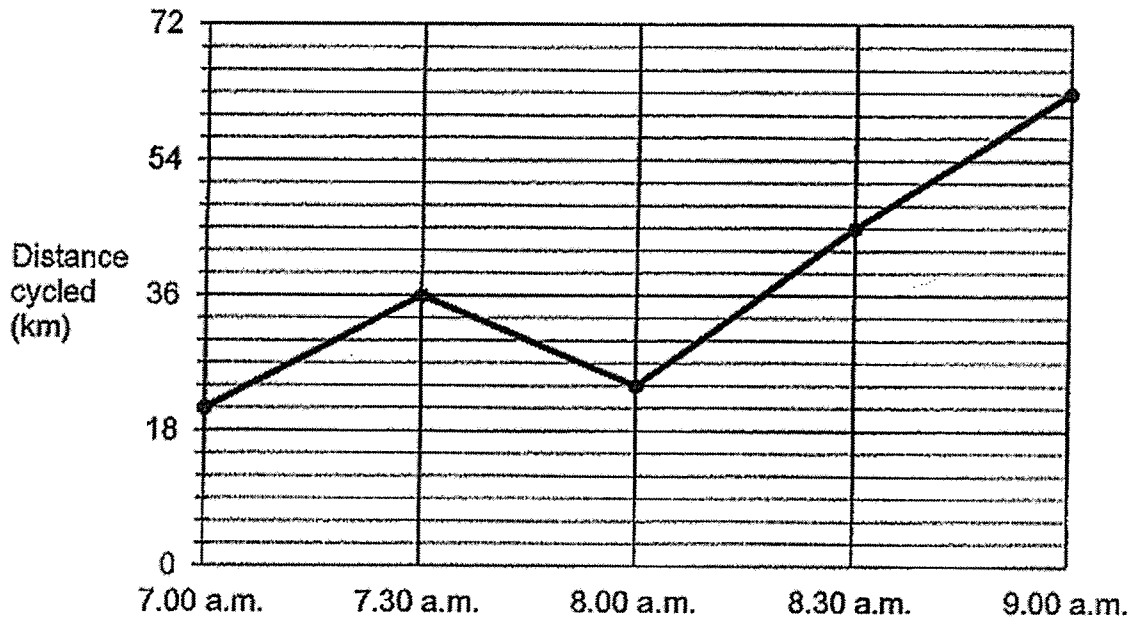

During which one-hour period was the distance cycled by Kailli the longest?

Ans: From _____ a.m. to _____ a.m.

Questions 21 to 30 carry 2 marks each. Show your working clearly and write your answers in the spaces provided. For questions which require units, give your answers in the units stated. (20 marks)

Do not write in this space

21. The table below shows the number of points scored by a group of boys and girls in a quiz. What is the total number of boys and girls who scored at least 4 points?

Number of points scored	1	2	3	4	5
Number of boys	3	9	13	8	7
Number of girls	4	11	6	12	10

Ans: _____

22. Pam went shopping with $\$14d$. She bought a fan for $\$5d$. She also bought an oven at $\$60$ more than the fan. How much money did she have left? Leave your answer in terms of d .

Ans: \$ _____

23. In the figure, JKLM is a parallelogram. $\angle KJM = 112^\circ$ and $\angle LMN = 39^\circ$. KLN is a straight line. Find $\angle MNL$.

Do not write in this space

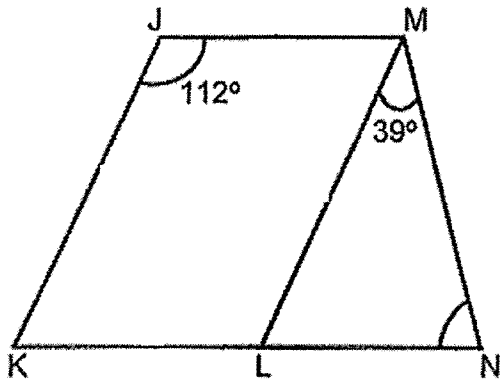

Ans: _____^o

24. The figure below is made up of identical squares. Shade the least number of squares so that AB is the line of symmetry.

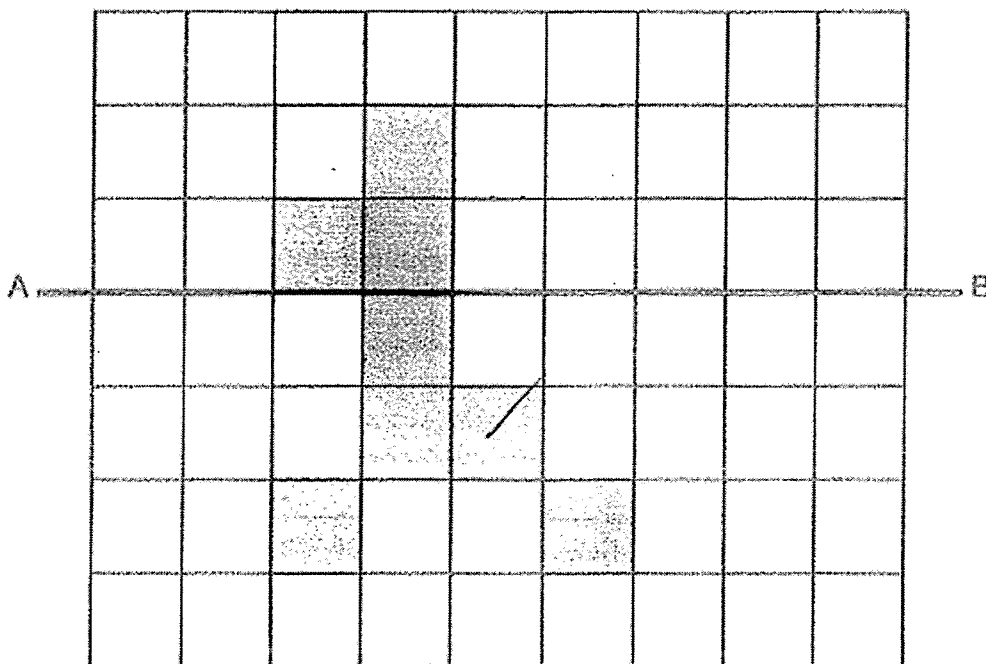

25. At first, a container was $\frac{3}{5}$ filled with lemonade. Then 140 cm^3 of lemonade was poured into the container. In the end, the container was $\frac{5}{8}$ filled. What is the capacity of the container?

Do not
write in
this space

Ans: _____ cm^3

26. Ramesh walked from his house to the park. He walked at a speed of 5 km/h and took 24 minutes to reach the park. If he had walked 1 km/h slower, how long would he take to reach the park?

Ans: _____ h

--

27. In the figure below, two identical poles are taped together.

Do not
write
in this
space

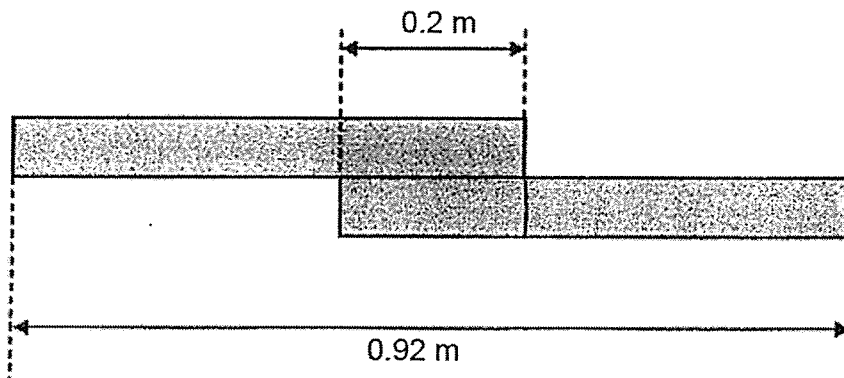

What is the length of each pole?

Ans: _____ cm

28. The bar graph below shows the number of eggs sold at a market over 4 days. The number of eggs sold on Sunday was smudged with ink. The average number of eggs sold over the 4 days was 200.5. How many eggs were sold on Sunday?

Do not write in this space

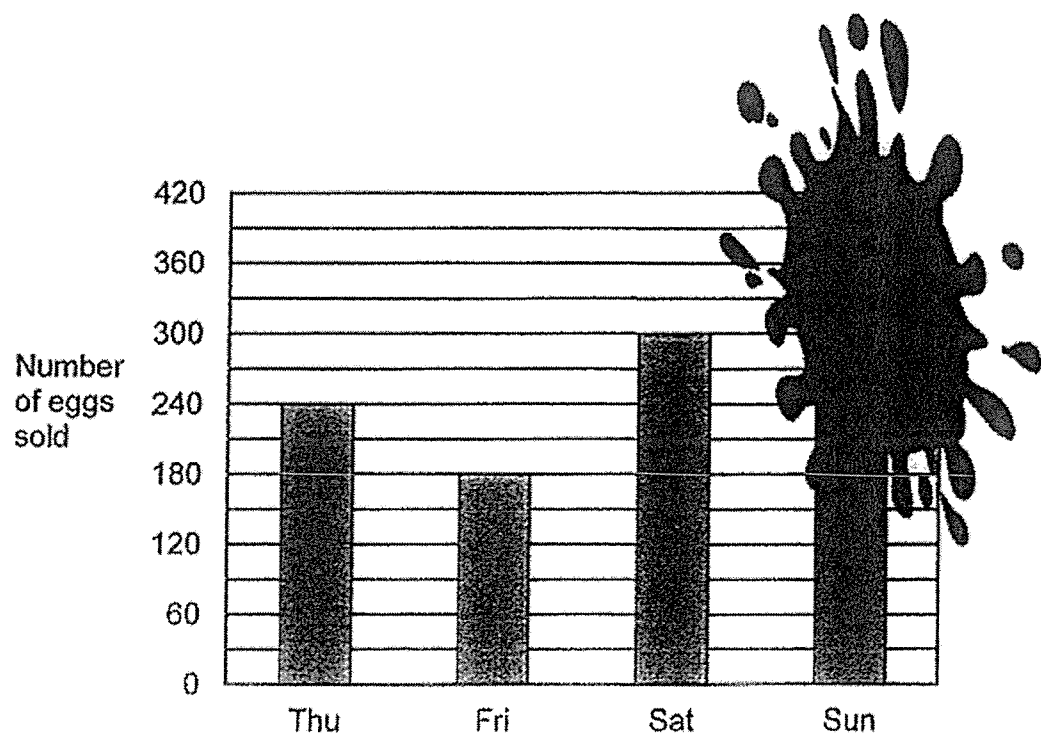

Ans: _____

MARKS:

29. There were a total of 71 chocolate buns and kaya buns in a box. $\frac{1}{2}$ of the chocolate buns was 8 more than $\frac{1}{3}$ of the kaya buns. How many kaya buns were there in the box?

Do not write in this space

Ans: _____

30. In the figure below, the area of triangle AEF is 18 cm^2 . Find the length of AB.

Do not write in this space

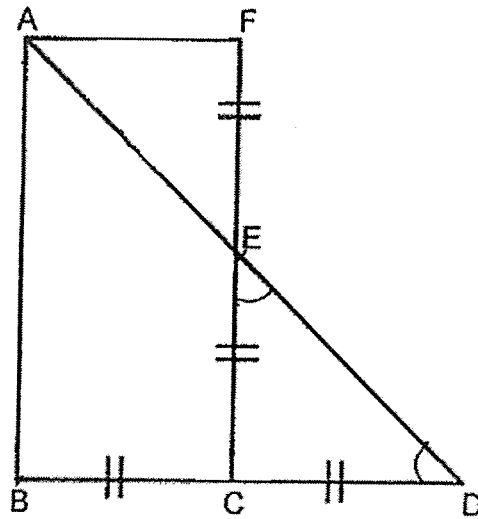

Ans: _____ cm^2

End of Paper

Name: _____ ()

Class: Primary 6 _____

CHIJ ST NICHOLAS GIRLS' SCHOOL (PRIMARY)

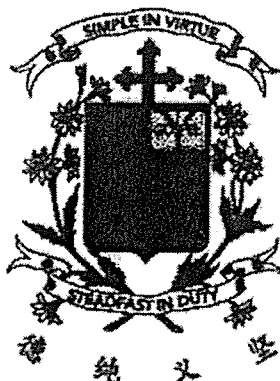

Primary 6 Mathematics

2022 Preliminary Examination

Paper 2

22 August 2022

Paper 1	45
Paper 2	55
Total Marks	100

Parent's/Guardian's Signature

Time : 1 hour 30 minutes

INSTRUCTIONS TO CANDIDATES

Do not turn over this page until you are told to do so.

Follow all instructions carefully.

Answer all questions.

Write your answers in this booklet

The use of an approved calculator is expected, where appropriate.

This booklet consists of 18 printed pages.

Questions 1 to 5 carry 2 marks each. Show your working clearly and write your answers in the spaces provided. For questions which require units, give your answers in the units stated. (10 marks)

Do not write in this space

1. Mika had \$80. She wanted to buy 25 muffins at \$7 each. How much money was she short of?

Ans : \$ _____

2. The figure is made up of 2 identical squares, P and Q, and a rectangle, R. The area of the figure is 512 cm^2 . The perimeter of P is 52 cm. Find the area of rectangle R.

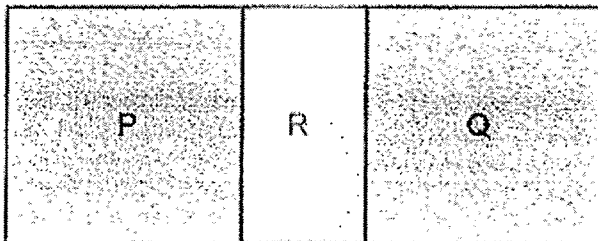

Ans : _____ cm^2

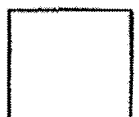

3. Using the grid below, draw and label trapezium WXYZ such that $\angle XYZ = 45^\circ$ and $\angle WXY = 90^\circ$. $XW = WZ = 5$ cm. Measure the length of XZ.

Do not write in this space

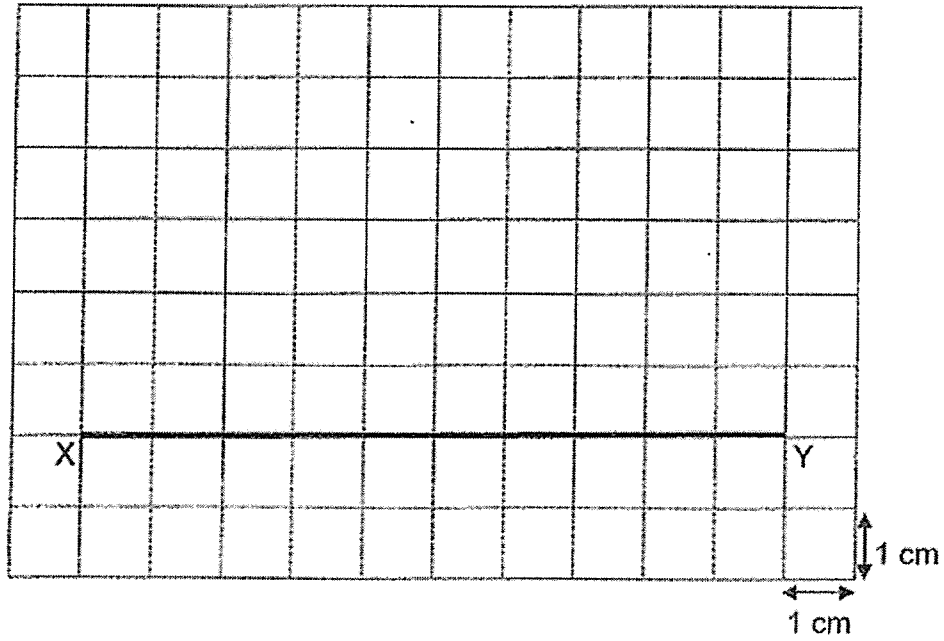

Ans : _____ cm

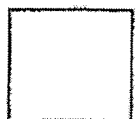

4. The figure shows a rectangle ABCD being folded along AE. Find $\angle CFE$.

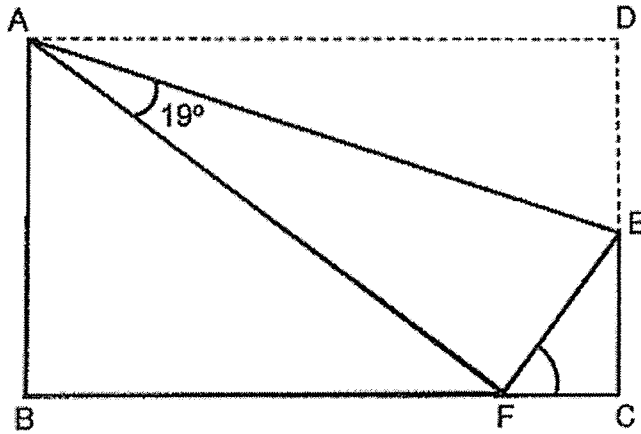

Do not
write
in this
space

Ans : _____ °



5. The line graph shows the amount of points needed to exchange for free gifts at a supermarket.

Do not write in this space

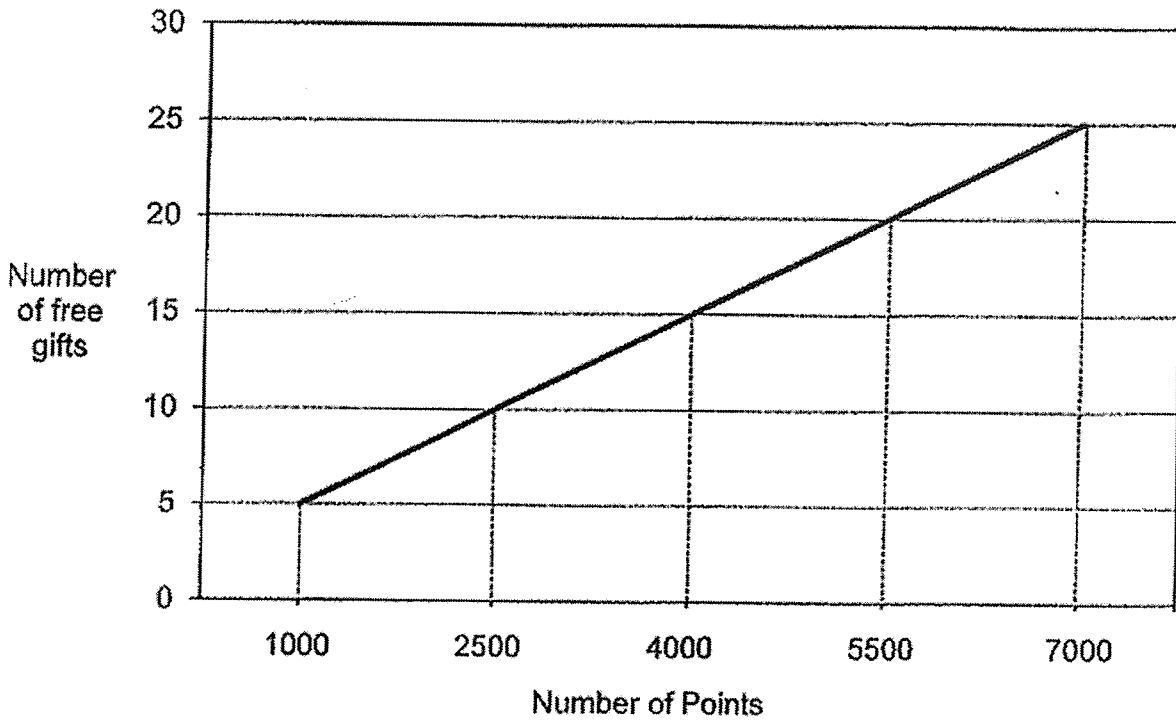

- (a) How many free gifts can be exchanged with 2800 points?

Ans : (a) _____

- (b) Kai Feng has already earned 2000 points. How many more points does he need in order to exchange for a total of 27 free gifts?

Ans : (b) _____



For questions 6 to 17, show your working clearly and write your answers in the spaces provided. The number of marks available is shown in the brackets () at the end of each question or part-question. (45 marks)

Do not write in this space

6. Box Q and Box R contained a total of 126 beads. Another 24 beads were put into Box R. Then Box Q contained 2 more beads than Box R. How many beads were there in each box at first?

Ans : Box Q _____ [2]

Box R _____ [1]

7. At a cafe, Mona bought 6 chicken wings. She also bought 3 fruit tarts at \$1.50 each. Laretta bought 9 chicken wings. Altogether, Mona spent \$3.90 less than Laretta. How much did 1 such chicken wing cost?

Ans : _____ [3]



8. Brantley is $5k$ years old now. In 8 years' time, Brantley will be 4 times as old as Hailey.

Do not write in this space

(a) Find Hailey's age in 8 years' time in terms of k .

Ans : (a) _____ [1]

(b) Given $k = 12$, find Hailey's age now.

Ans : (b) _____ [2]



9. Papers of different masses were sold at Crafty Paper. The prices for the masses of paper are shown in the table below. Ethan chose a stack consisting of 35 sheets of paper which had a mass of 15 g each. How much did he pay altogether?

Do not write in this space

Mass of paper (grams) not exceeding	Price
50 g	\$2
120 g	\$4.50
200 g	\$8.00
For every additional 100 g or part thereof	\$3.80

Ans : _____ [3]

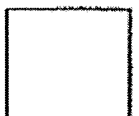

10. A rectangular tank measuring 125 cm by 60 cm was filled with water to a height of 14 cm. When 30 ℓ of water were removed from the tank, the water level dropped to $\frac{2}{5}$ of the height of the tank. What is the capacity of the tank?

Do not write in this space

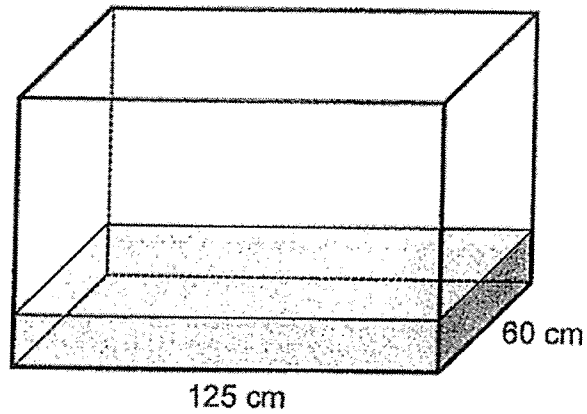

Ans : _____ [3]



11. ABCD is a rhombus. BD and BE are straight lines.

Do not
write
in this
space

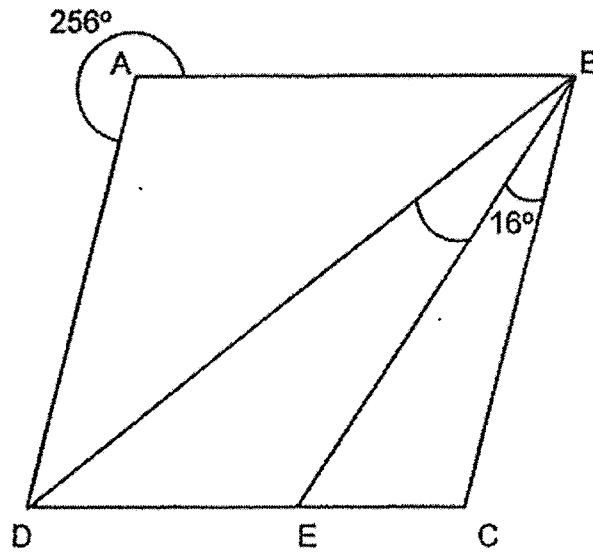

(a) Circle the words that describe BCD in the statement:

BCD (is / is not) an isosceles triangle because BC (is / is not) equal to CD.

[1]

(b) Find $\angle DBE$.

Ans : (b) _____ [2]

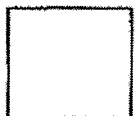

12. The bar graph shows the number of each type of burgers sold at a fast food restaurant on a Friday.

Do not write in this space

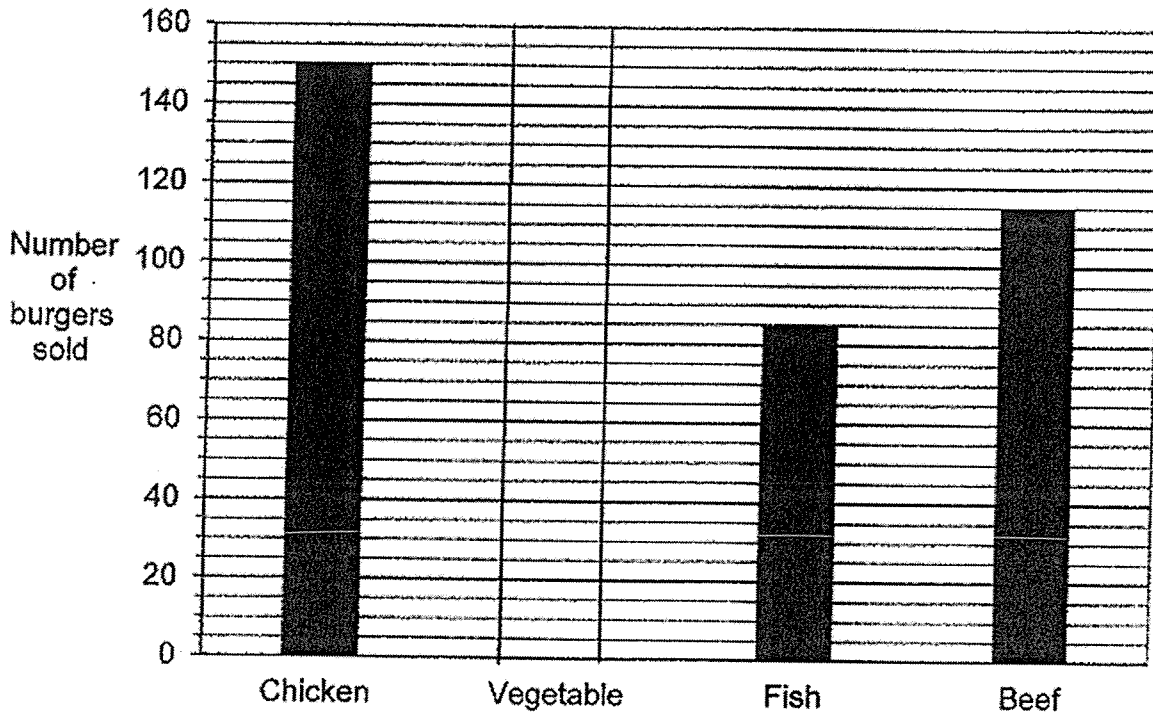

The table shows the prices of each type of burger.

Type of burger	Price
Chicken	\$4.50
Vegetable	\$3.80
Fish	\$4.20
Beef	\$5.50

(a) The restaurant collected a total amount of \$437 from the sale of vegetable burgers. How many vegetable burgers were sold? Draw the bar to show the number of vegetable burgers sold. [2]

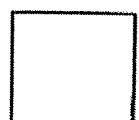

(b) What was the difference in the amount collected from the most popular burger sold and the least popular burger sold?

Do not write in this space

Ans : (b) _____ [2]

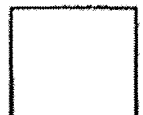

13. Alan, Brian, Carl and Dan share a box of game cards. The ratio of the number of game cards Alan has to the total number of game cards Brian, Carl and Dan have is 1 : 5. The ratio of the number of game cards Brian has to the total number of game cards Alan, Carl and Dan have is 5 : 7.

Do not
write
in this
space

(a) Find the ratio of the number of game cards Alan has to the number of game cards Brian has.

Ans : (a) _____ [1]

(b) Alan has 30 game cards. How many more game cards must he buy so that he has twice as many game cards as Brian?

Ans : (b) _____ [3]

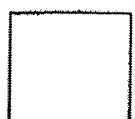

14.

Membership Promotion!

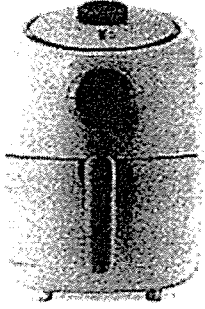

Buy first air fryer
at 15% discount

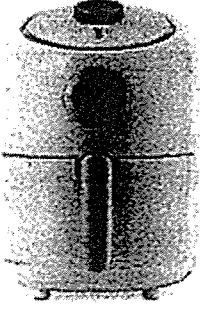

Buy second air fryer
at 30% discount

For non-members, enjoy a 10% discount for each air fryer.

Do not
write
in this
space

Mrs Wong paid \$341 for two air fryers by using the membership promotion shown above. How much would she have paid for 1 air fryer if she was a non-member?

Ans : _____ [4]



15. Fredrick had some coupons to sell at a funfair. Each coupon cost \$5. On the first day, he sold 264 coupons. On the second day, he sold $\frac{1}{5}$ of the remaining coupons. On the third day, he sold the rest of the coupons, and this was $\frac{1}{3}$ of the total number of coupons sold on the first two days.

Do not
write
in this
space

(a) What fraction of the total number of coupons did Fredrick sell on the first day?

Ans : (a) _____ [2]

(b) Each coupon cost \$5. What was the total amount of money Fredrick collected from the sale of coupons over the three days?

Ans : (b) _____ [3]

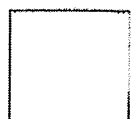

16. EFG and KLN are triangles. KLN is an equilateral triangle. $KL \parallel JG$ and $JG \parallel MN$.

Do not write in this space

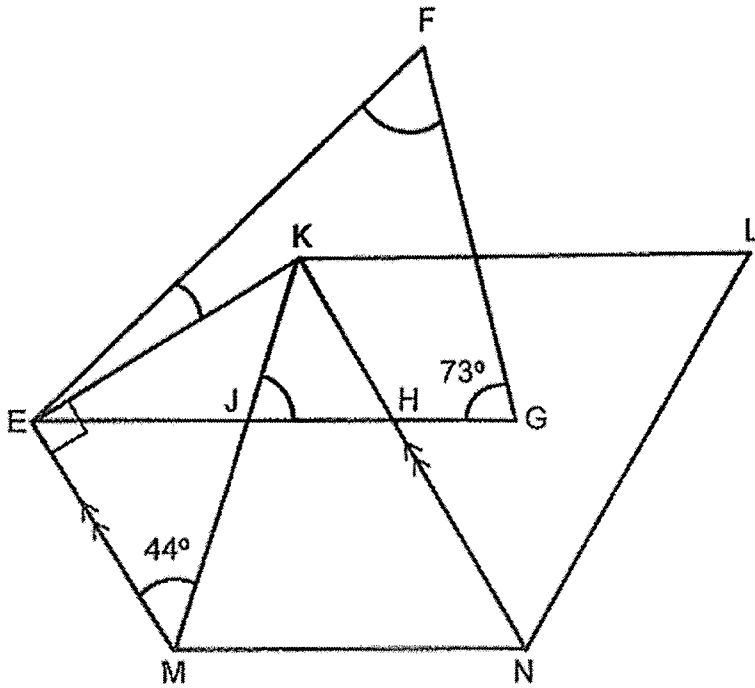

- (a) Find the sum of $\angle FEK$ and $\angle GFE$.

Ans: (a) _____ [4]

- (b) Find $\angle KJH$.

Ans: (b) _____ [1]



17. The rectangle is made up of identical squares of side 28 cm each. The outline of the shaded figure is formed by 5 identical quarter circles, 4 identical semicircles and two straight lines.

Do not write in this space

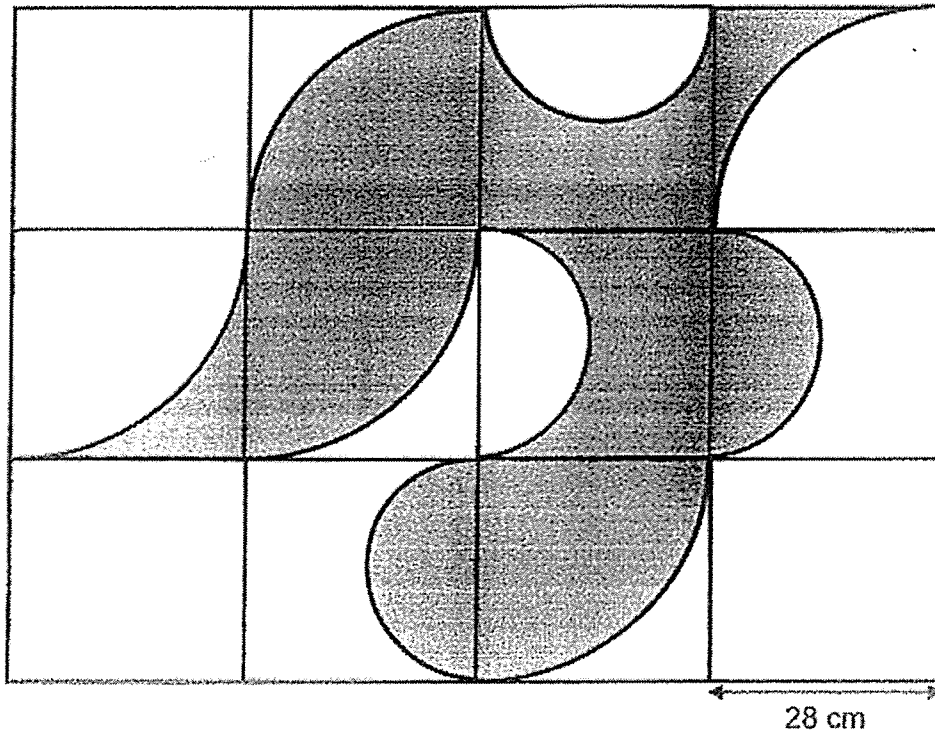

- (a) What is the perimeter of the shaded figure? (Take $\pi = \frac{22}{7}$)

Ans : (a) _____ [3]

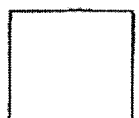

(b) What is the area of the shaded figure? (Take $\pi = \frac{22}{7}$)

Do not
write
in this
space

Ans : (b) _____ [2]

End of Paper



SCHOOL : CHIJ PRIMARY SCHOOL
 LEVEL : PRIMARY 6
 SUBJECT : MATHEMATICS
 TERM : 2022 PRELIMS

PAPER 1 BOOKLET A

Q 1	Q2	Q3	Q4	Q5	Q6	Q7	Q8	Q9	Q10
4	2	2	3	3	3	1	2	2	3

Q 11	Q12	Q13	Q14	Q15
3	2	3	4	2

PAPER 1 BOOKLET B

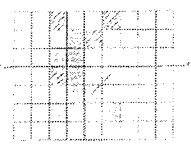
Q16)	8.45
Q17)	$\frac{14}{5}$, 2 , $1\frac{9}{10}$, $\frac{9}{6}$
Q18)	$\frac{1}{1000}$
Q19)	1.3kg
Q20)	8 a.m. to 9 a.m.
Q21)	$8 + 7 + 12 + 10$ $= 37$
Q22)	$14d - 5d - (5d + 60)$ $= 4d - 60$ $= \$(4d - 60)$
Q23)	$180 - 112 = 68$ $180 - 68 - 39 = 73^\circ$
Q24)	

Q25	$\frac{5}{6} - \frac{3}{5} = \frac{25}{30} - \frac{18}{30}$ $= \frac{7}{30}$ $\frac{7}{30} = 140$ $\frac{1}{30} = 140 \div 7 = 20$ $\frac{30}{30} = 20 \times 30$ $= 600\text{cm}^3$
Q26	$S \times T = 5 \times \frac{24}{60}$ $= 2\text{km}$ $\text{New speed} = 5 - 1$ $= 4$ $2 \div 4 = \frac{1}{2} \text{h}$
Q27	$0.92 - 0.2 = 0.72$ $\frac{0.72}{2} = 0.36$ $0.36 + 0.2 = 0.56$ $0.56 \times 100 = 56\text{cm}$
Q28	$200.5 \times 4 = 802$ $802 - 240 - 180 - 300$ $= 562 - 180 - 300$ $= 562 - 480$ $= 82$
Q29	$\frac{71+(8 \times 3)}{5} = \frac{71+24}{5}$ $= \frac{95}{5}$ $= 19$ $(19 \times 3) - 24 = 57 - 24$ $= 33$
Q30	$\frac{1}{2} \times AF \times FE = 18$ $AF \times FE = 18 \times 2$ $= 36$ $36 \div 6 = 6$ $6 + 6 = 12\text{cm}$

PAPER 2

Q1)	$(25 \times 7) - 80 = \$95$
Q2)	$52 \div 4 = 13$ $(13 \times 13) \times 2 = 338$ $512 - 338 = 174\text{cm}^2$
Q3)	7cm
Q4)	$19 + 19 = 38$ $90 - 38 = 52$ $180 - 90 - 38 = 52^\circ$
Q5)	a) $2500 - 1000 = 1500$ $10 - 5 = 5$ $1500 \div 5 = 300$ $2800 - 1000 = 1800$ $1800 \div 300 = 6$ $6 + 5 = 11$ b) $27 - 5 = 22$ $22 \times 300 = 6600$ $6600 + 1000 = 7600$ $7600 - 2000 = 5600$
Q6)	$(126 + 24) - 2 = 148$ $148 \div 2 = 74$ $Q = 74 + 2 = 76$ $R = 74 - 24 = 50$ Box Q = 76 Box R = 50
Q7)	$9\text{cw} = 6\text{cw} + 8.40$ $3\text{cw} = 8.40$ $1\text{cw} = \frac{8.40}{3}$ $= \$2.80$
Q8)	a) $\left(\frac{5k+8}{4}\right)$ b) $12 \times 5 = 60$ $\frac{60+8}{4} = 17$ $17 - 8 = 9$
Q9)	$35 \times 15\text{g} = 525\text{g}$ $8 + (3.80 \times 4) = \$23.20$
Q10)	$125 \times 60 \times 14 = 105000$ $(105000 \div 1000) - 30 = 75$

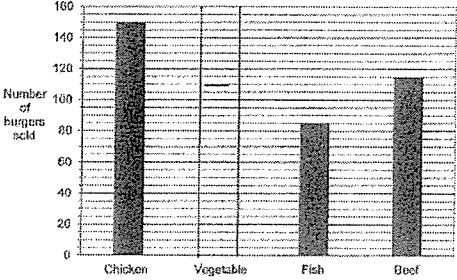
	$75 \ell = 75 \times 1000$ $= 75000 \text{ml}$ $75000 \div 125 \div 60 = 10$ $\frac{2}{5} = 10$ $\frac{1}{5} = 10 \div 2$ $= 5$ $\frac{5}{5} = 5 \times 5 = 25$ $125 \times 60 \times 25 = 187500 \text{cm}^3$										
Q11)	a) is / is b) $360 - 256 = 104$ $\frac{180 - 104}{2} = 38$ $38 - 16 = 22^\circ$										
Q12)	a) $437 \div 3.80$ $= 115$  <table border="1"> <caption>Number of burgers sold by category</caption> <thead> <tr> <th>Category</th> <th>Number of burgers sold</th> </tr> </thead> <tbody> <tr> <td>Chicken</td> <td>150</td> </tr> <tr> <td>Vegetable</td> <td>0</td> </tr> <tr> <td>Fish</td> <td>80</td> </tr> <tr> <td>Beef</td> <td>115</td> </tr> </tbody> </table> b) $150 \times 4.50 = 675$ $85 \times 4.20 = 357$ $675 - 357 = \$318$	Category	Number of burgers sold	Chicken	150	Vegetable	0	Fish	80	Beef	115
Category	Number of burgers sold										
Chicken	150										
Vegetable	0										
Fish	80										
Beef	115										
Q13)	a) 2 : 5 b) 2 units = 30 $1 \text{ unit} = 30 \div 2$ $= 15$ $10 \text{ units} = 15 \times 10$ $= 150$ $150 - 30 = 120$										
Q14)	$200 - 15 - 30 = 155$ $155\% = 341$ $1\% = 341 \div 155$ $= 2.2$										

	$100\% = 2.2 \times 100$ $= \$220$
Q15)	<p>a) $1\text{part} = 4u$ $3\text{parts} = 4 \times 3$ $= 12u$ $12u - 1u = 11u$ $12 + 4 = 16$ $\text{Ans} = \frac{11}{16}$</p> <p>b) $11\text{units} = 264$ $1\text{unit} = 264 \div 11$ $= 24$ $16\text{units} = 16 \times 24$ $= 384$ $384 \times \\$5 = \\1920</p>
Q16)	<p>a) $\angle EKL = 90^\circ + 60^\circ$ $= 150^\circ$ $\angle KEJ = 180^\circ - 150^\circ$ $= 30^\circ$ $180^\circ - 30^\circ - 73^\circ = 77^\circ$</p> <p>b) $\angle JEM = 90^\circ - 30^\circ$ $= 60^\circ$ $\angle MKN = 180^\circ - 60^\circ - 44^\circ$ $= 76^\circ$</p>
Q17)	<p>a) $28 \times 2 = 56$ $\frac{1}{4} \pi d = \frac{1}{4} \times \frac{22}{7} \times 56$ $= 44$ $44 \times 5 = 220$ $\frac{1}{4} \times 4 \times \pi d = \frac{1}{2} \times 4 \times \frac{22}{7} \times 28$ $= 176$ $176 + 220 + (28 \times 2)$ $= 452\text{cm}$</p> <p>b) $(28 \times 28) \times 4 = 3136$ $\frac{1}{4} \times \frac{22}{7} \times 28 \times 28 = 616$ $3136 + 616 = 3752\text{cm}^2$</p>

