



**CATHOLIC HIGH SCHOOL**  
**END-OF-YEAR EXAMINATION (2022)**

**PRIMARY FIVE**

**SCIENCE**

**BOOKLET A**

Name: \_\_\_\_\_ ( )

Class: Primary 5 - \_\_\_\_\_

Date: 28 October 2022

28 questions

56 marks

Total Time for Booklets A and B: 1 hour 45 minutes

**INSTRUCTIONS TO CANDIDATES**

Do not turn over this page until you are told to do so.

Follow all instructions carefully.

Answer all questions.

Shade your answers in the Optical Answer Sheet (OAS) provided.

This booklet consists of 19 printed pages, excluding the cover page.

**Booklet A (28 × 2 marks)**

For each question from 1 to 28, four options are given. One of them is the correct answer. Make your choice (1, 2, 3 or 4). Shade your answer on the Optical Answer Sheet. (56 marks)

- 1 The table shows the characteristics of four things, A, B, C and D. A tick (✓) indicates the presence of the characteristic.

Thing	needs air, food and water	can make food	can move from place to place	has four legs
A	✓		✓	✓
B				✓
C	✓		✓	
D	✓	✓		

Which of the following correctly represents A, B, C and D?

	A	B	C	D
(1)	bee	hibiscus plant	chair	giraffe
(2)	giraffe	chair	hibiscus plant	bee
(3)	chair	bee	giraffe	hibiscus plant
(4)	giraffe	chair	bee	hibiscus plant

2 . Study the diagram.

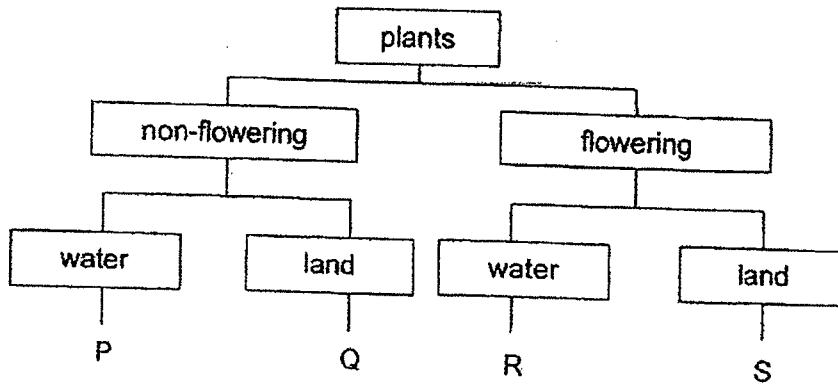

Plant G reproduces from spores and grows on the branches of a tall tree.

Based on the characteristics of plant G, which letter, P, Q, R or S, represents plant G?

- (1) P
- (2) Q
- (3) R
- (4) S

3 The diagram shows the human digestive system.

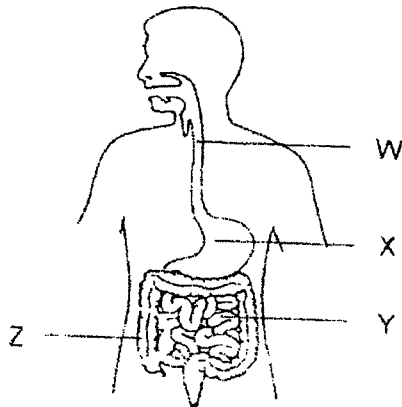

Which of the following correctly shows the functions of the organs?

	absorption of digested food	absorption of water
(1)	W	X
(2)	X	Y
(3)	Y	Z
(4)	Z	Y

- 4 Which plant part is **not** matched correctly to its functions?

	plant part	function
(1)	seed	to grow into a new plant
(2)	leaf	to make food for the plant
(3)	stem	to anchor the plant firmly to the ground
(4)	root	to absorb water and mineral salts from the soil

- 5 The diagrams show the stages of the development of a seed.

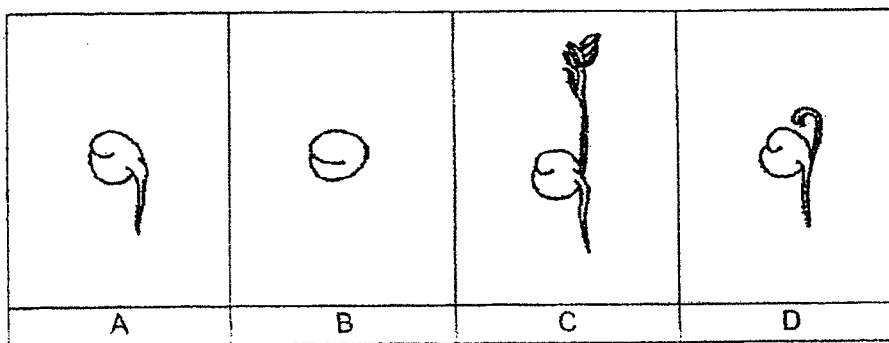

Which of the following shows the correct order of growth of a seed?

- (1) B → A → C → D  
 (2) B → A → D → C  
 (3) B → D → A → C  
 (4) B → D → C → A

- 6 Squirrels store a large number of nuts during winter. The squirrels often eat the nuts halfway because the bottom part of the nut tastes bitter. As the winter turns to spring, these half-eaten nuts can still germinate and grow into young plants.

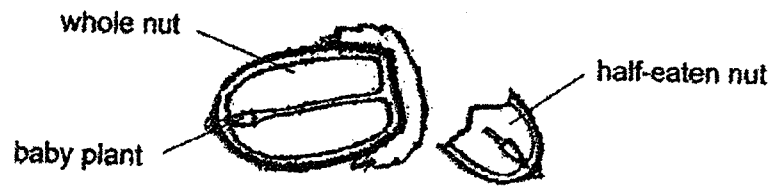

Which are possible reasons why the half-eaten nuts can still germinate and grow into young plants?

- A They receive light to germinate.
- B There is food stored for the young plant.
- C The baby plant is found at the bottom of each nut.
- D There is warmth for germination when winter turns to spring.

- (1) A and C only
- (2) B and D only
- (3) B, C and D only
- (4) A, B, C and D

- 7 Raja conducted an experiment using two insect-pollinated flowers, P and Q, from the same plant. The diagram shows the parts of one flower.

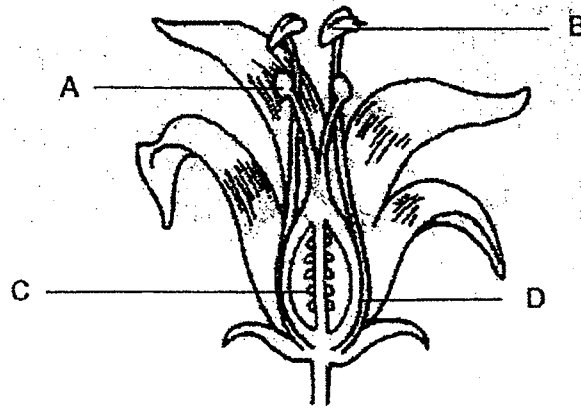

He removed a part from flower P and another part from flower Q. He recorded his observations of the development of the flower over time.

flower	develops into a fruit
P	yes
Q	no

Which of the following shows the parts removed from the flowers?

	flower P	flower Q
(1)	A	B
(2)	C	D
(3)	C	A
(4)	B	D

8 The diagrams show the human and the plant reproductive systems.

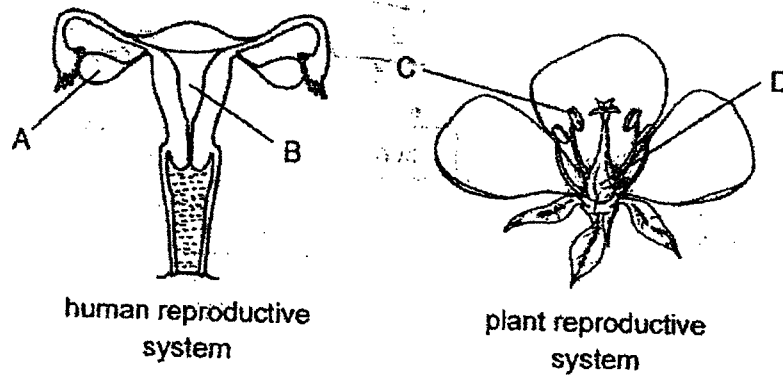

Which statement is correct about both reproductive systems?

	part	statement
(1)	A and C	Both parts produce female reproductive cells.
(2)	A and D	Both parts need to be present for fertilisation to occur.
(3)	B and C	Both parts produce male reproductive cells.
(4)	B and D	The male and female reproductive cells fuse in these parts.

9 The table shows some characteristics of Jane's parents and herself.

	has dimples	able to roll tongue	long hair
Jane's father	No	Yes	No
Jane's mother	Yes	No	Yes
Jane	Yes	Yes	No

Based on the table, how many characteristics did Jane inherit from each of her parents?

- (1) one from father and one from mother
- (2) one from father and two from mother
- (3) two from father and one from mother
- (4) two from father and two from mother

10 The diagram shows how water and food are transported in a plant.

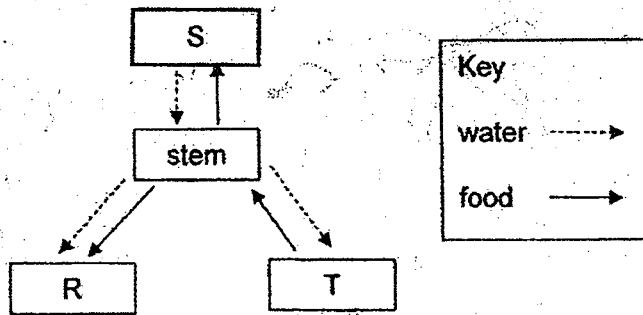

Which of the following correctly shows the parts of the plant?

	R	S	T
(1)	roots	flowers	leaves
(2)	leaves	roots	flowers
(3)	flowers	leaves	roots
(4)	flowers	roots	leaves

11 The diagram shows how food and various gases are transported in the human body.

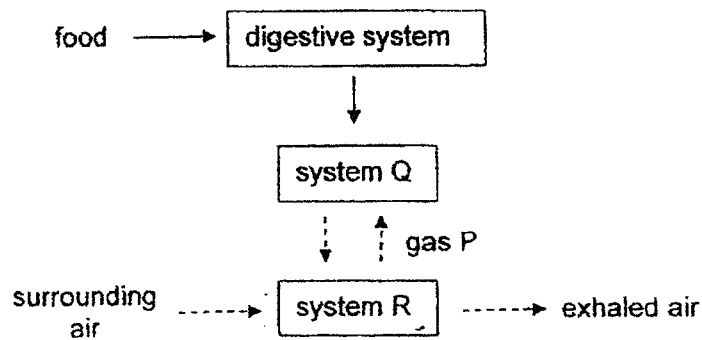

What are systems Q and R and gas P?

	system Q	system R	gas P
(1)	circulatory	respiratory	oxygen
(2)	respiratory	circulatory	oxygen
(3)	circulatory	respiratory	carbon dioxide
(4)	respiratory	circulatory	carbon dioxide

- 12 Diagrams 1 and 2 show how gases are transported in the circulatory system of a fish and a human respectively.

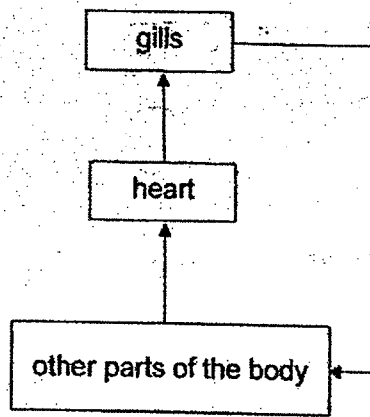

diagram 1

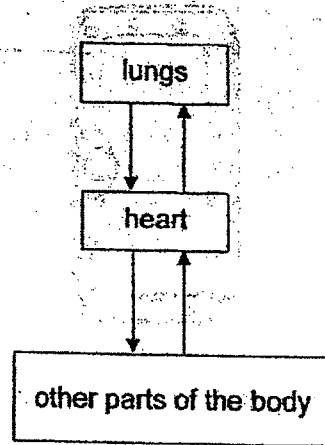

diagram 2

Based on the diagrams, which statement(s) is/are correct?

- A A fish has a single circulation but a human has a double circulation.
- B Exchange of gases takes place in the gills for the fish and lungs for the human.
- C The human circulatory system transports substances around the body but the fish circulatory system does not transport substances around the body.

- (1) A only
- (2) A and B only
- (3) B and C only
- (4) A, B and C

13 The diagram shows two cells.

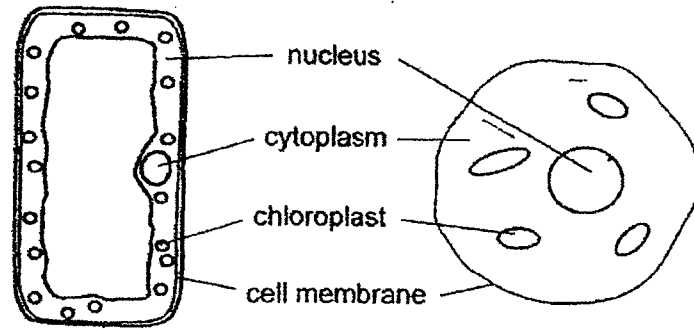

Which part is labelled correctly?

- (1) nucleus
- (2) cytoplasm
- (3) chloroplast
- (4) cell membrane

14 The table shows the characteristics of two cells, G and H. A tick (✓) indicates the presence of the characteristic.

parts of the cell	cell G	cell H
cell wall	✓	
nucleus	✓	✓
chloroplast		
cell membrane	✓	✓

Which of the following correctly represents cells G and H?

	cell G	cell H
(1)	cheek cell	root cell
(2)	root cell	cheek cell
(3)	root cell	leaf cell
(4)	leaf cell	cheek cell

- 15 The diagram shows a certain process that takes place in green plants.

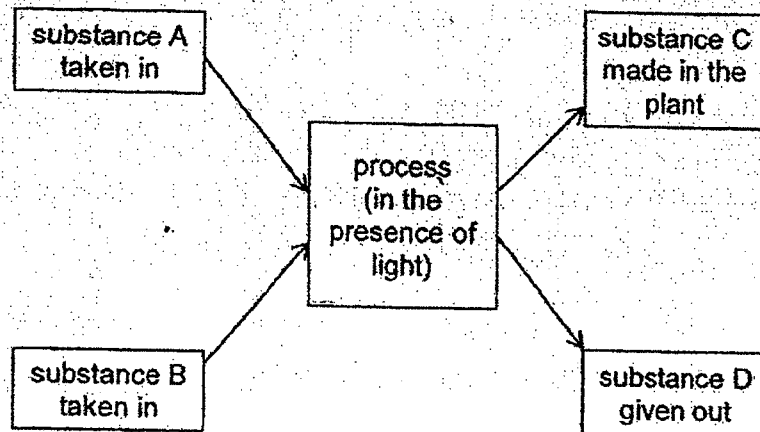

Which of the following correctly identifies substances A, B, C and D?

	substance A	substance B	substance C	substance D
(1)	food	water	oxygen	carbon dioxide
(2)	oxygen	food	carbon dioxide	water
(3)	carbon dioxide	water	food	oxygen
(4)	carbon dioxide	food	oxygen	water

- 16 Wei Yang plucked a leaf from a plant and placed it in a beaker of hot water.

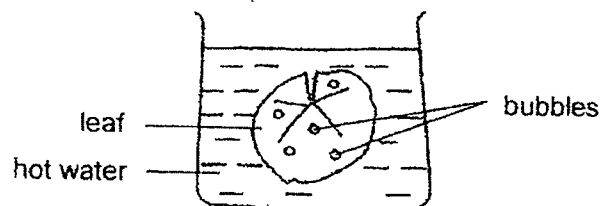

He observed that the bubbles formed only on the upper surface of the leaf.

Which statement is correct?

- (1) Bubbles formed in the water and landed on the upper surface of the leaf.
- (2) Air escaped through tiny openings found on both surfaces of the leaf.
- (3) The leaf had tiny openings on the upper surface but not on the lower surface.
- (4) Air entered the lower surface of the leaf and escaped through the upper surface.

- 17 Pete painted the glass jar black and watered the plant before placing the set-up in the sun. He measured the amount of oxygen in the glass jar from 7 am to 7 pm.

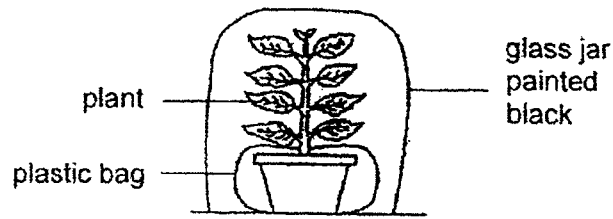

Which graph shows how the amount of oxygen in the glass jar changed from 7 am to 7 pm?

(1)

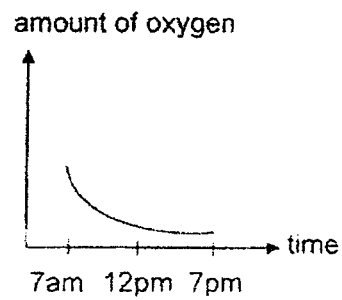

(2)

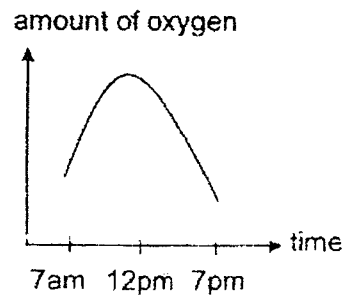

(3)

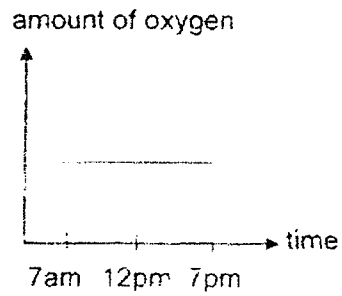

(4)

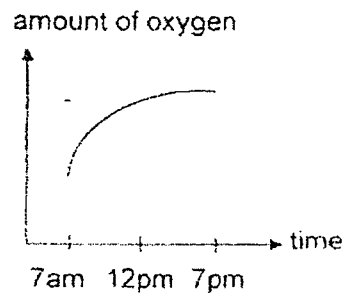

- 18 Devi wanted to find out if adding fertiliser to four similar plants P, Q, R and S, would affect the rate of photosynthesis. The table shows the conditions for the four plants.

	plant			
	P	Q	R	S
amount of water (ml)	60	60	60	0
amount of light (units)	4000	0	4000	2000
amount of fertiliser (g)	0	12	6	12

Which two plants should she use for her experiment?

- (1) P and R
  - (2) P and S
  - (3) Q and R
  - (4) Q and S
- 19 The diagram shows a leaf on a plant. At the start of the experiment, there was no food on the leaf.

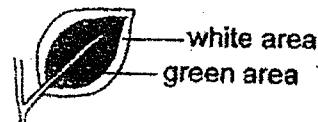

Next, the leaf was partly covered by black papers as shown.

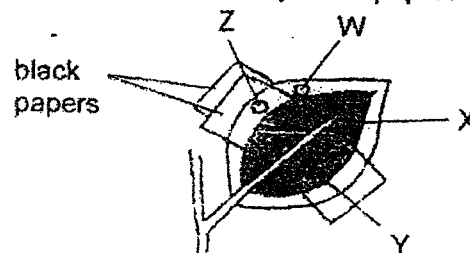

The plant was then put in the sun. After several hours, the leaf was plucked and the black papers were removed. The leaf was tested for food.

Which part(s), W, X, Y and Z, is/are food mostly found?

- (1) W only
- (2) X only
- (3) W and X only
- (4) Y and Z only

20 Five magnets are arranged as shown.

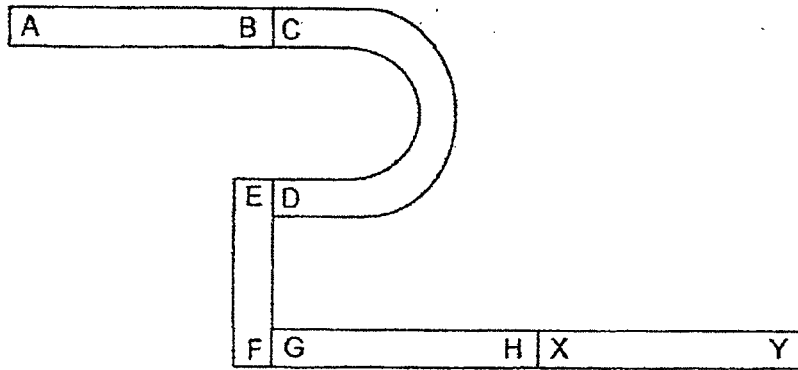

Which arrangement is not possible?

(1)

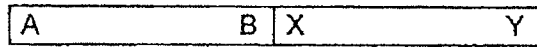

(2)

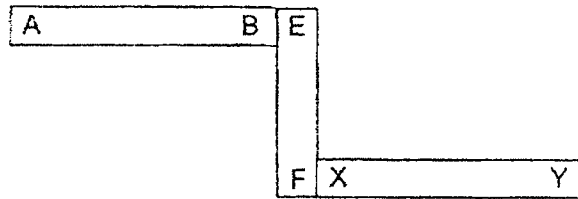

(3)

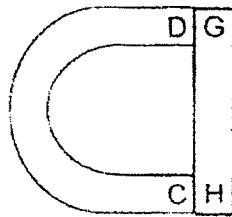

(4)

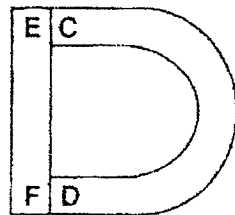

21 Study the diagram.

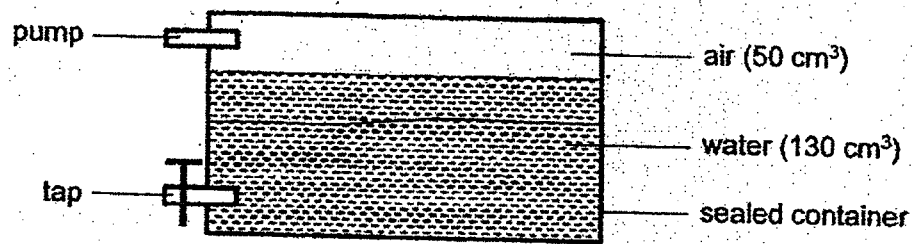

Mayah used the tap to remove 30 cm<sup>3</sup> of water. She then used the pump to add 20 cm<sup>3</sup> of air into the container.

What was the final volume of air in the container?

- (1) 50 cm<sup>3</sup>
- (2) 70 cm<sup>3</sup>
- (3) 80 cm<sup>3</sup>
- (4) 100 cm<sup>3</sup>

22 Shapes P, Q and R are made of cardboard. They are placed at different distances from the torch.

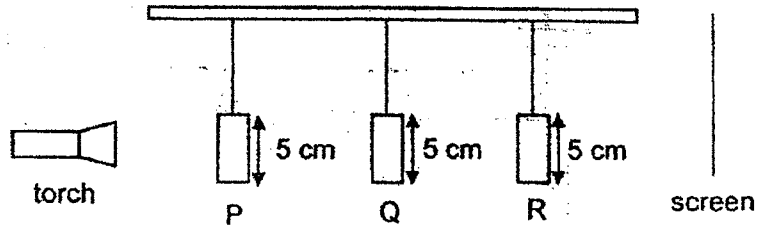

The shapes of the objects are as shown.

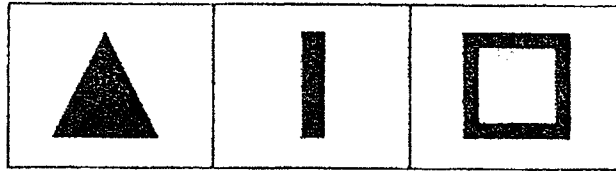

The diagram below shows the shadows that were cast on the screen.



Which of the following correctly represents shapes, P, Q and R?

	P	Q	R
(1)			
(2)			
(3)			
(4)			

23 A beaker of ice was heated for 30 minutes and then left on the table to cool to room temperature. The changes in the temperature were recorded on a graph.

Which graph correctly shows the changes in the temperature over a period of time?

(1)

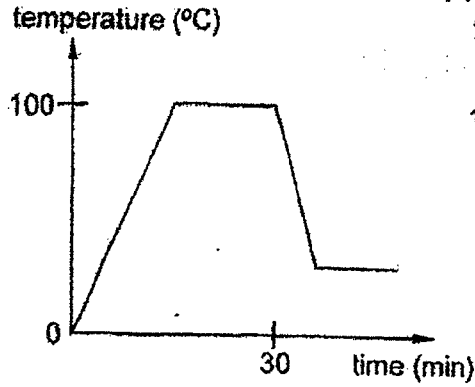

(2)

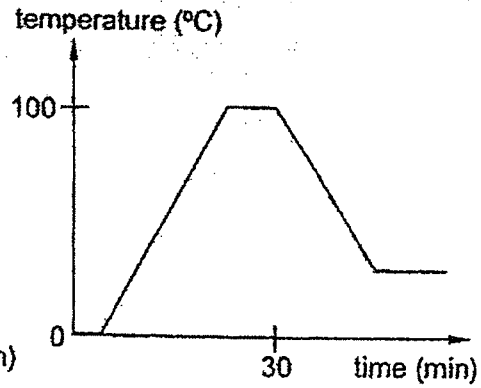

(3)

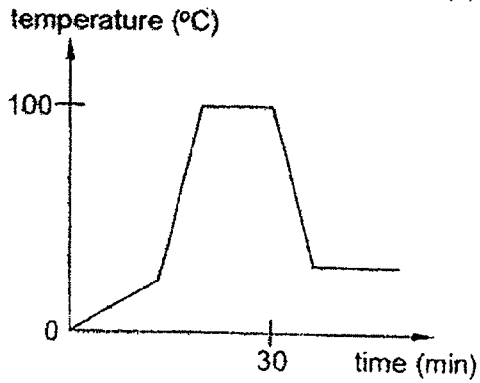

(4)

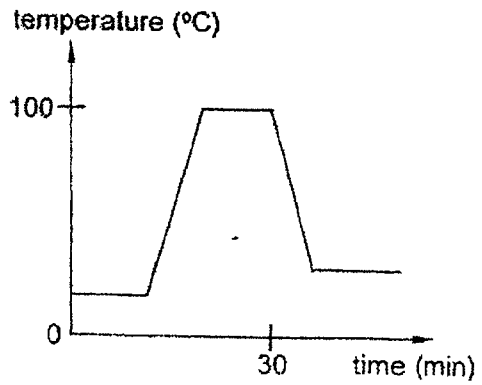

24 Study the diagram.

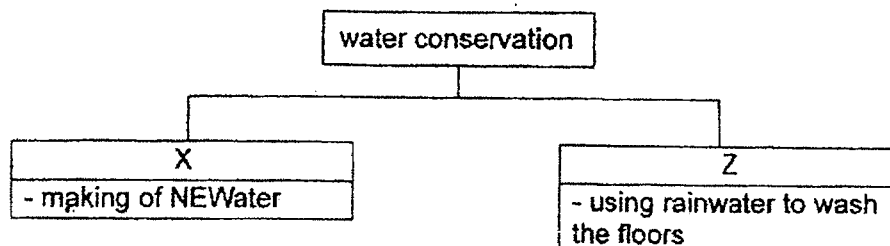

What do X and Z represent?

	X	Z
(1)	recycling	reducing
(2)	reducing	reusing
(3)	reusing	recycling
(4)	recycling	reusing

25 The table shows the melting and boiling points of substances A, B and C.

substance	melting point (°C)	boiling point (°C)
A	42	78
B	28	63
C	54	90

At which temperature will the three substances be in the same state?

- (1) 32°C
- (2) 60°C
- (3) 75°C
- (4) 80°C

26 Which of the following actions can we take to conserve electricity?

- A use air-conditioners
- B use energy-saving light bulbs
- C switching on the water heater only when you need it
- D switching on the electrical appliances when they are not in use

- (1) A and B only
- (2) B and C only
- (3) A, C and D only
- (4) B, C and D only

27 Bulbs D, E and F and switches P, Q and R are connected in a circuit as shown. All the components in the circuit are working properly.

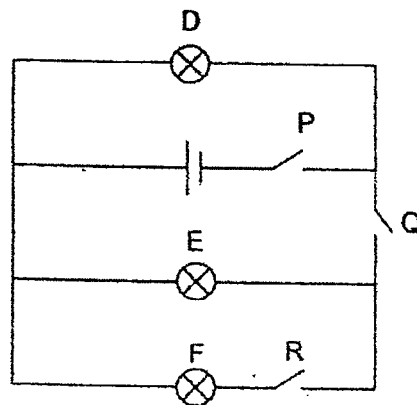

Which of the following is correct?

	Does the bulb light up?			Switch		
	D	E	F	P	Q	R
(1)	yes	yes	no	closed	closed	open
(2)	no	yes	no	open	closed	open
(3)	yes	no	yes	closed	open	closed
(4)	no	no	yes	open	open	closed

- 28 Suling wants to find out how the number of batteries will affect the brightness of the bulbs.

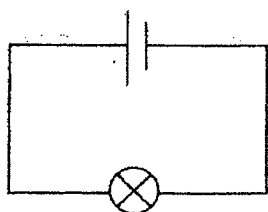

circuit R

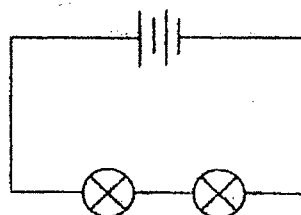

circuit S

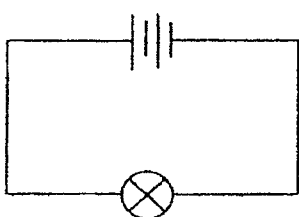

circuit T

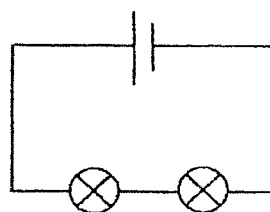

circuit U

Which circuits should she use for her experiment?

- (1) R and S
- (2) R and U
- (3) S and U
- (4) T and U

End of Booklet A



**CATHOLIC HIGH SCHOOL**  
**END-OF-YEAR EXAMINATION (2022)**

**PRIMARY FIVE**

**SCIENCE**

**BOOKLET B**

Name: \_\_\_\_\_ ( )

Class: Primary 5 - \_\_\_\_\_

Date: 28 October 2022

Parent's Signature: \_\_\_\_\_

Booklet A	56
Booklet B	44
<b>Total</b>	<b>100</b>

13 questions

44 marks

Total Time for Booklets A and B: 1 hour 45 minutes

**INSTRUCTIONS TO CANDIDATES**

Do not turn over this page until you are told to do so.  
 Follow all instructions carefully.  
 Answer all questions.  
 Write your answers in this booklet.

This booklet consists of 16 printed pages, excluding the cover page.

**Booklet B (44 marks)**

For questions 29 to 41, write your answers in this booklet.

The number of marks available is shown in brackets [ ] at the end of each question or part question. (44 marks)

29 Study the diagram.

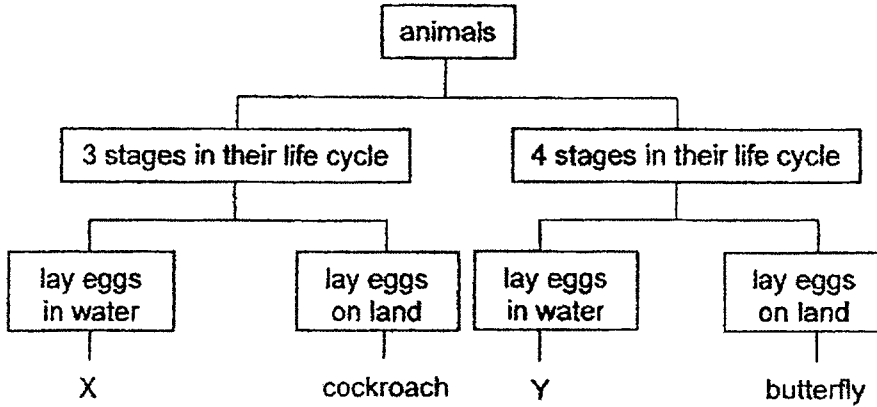

(a) Based on the diagram, state one difference between animals X and Y. [1]

---



---

The graph shows the mass of a beetle at different stages of its life cycle.

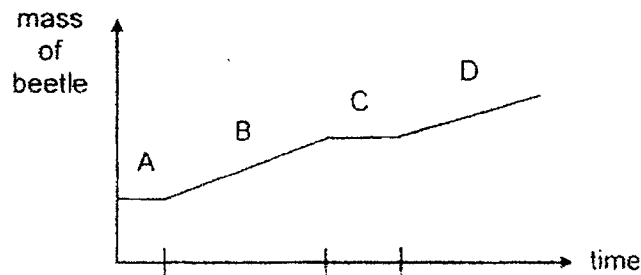

(b) Name stage C. Give a reason why there is no gain in mass during stage C. [1]

---



---

(Go on to the next page)

SCORE	2
-------	---

30 Siva observed plants P, Q and R growing on a piece of land as shown in diagram 1. After a few months, he visited the same piece of land and made the observations shown in diagram 2.

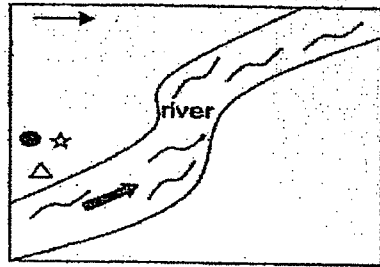

diagram 1

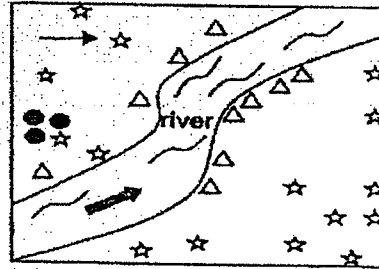

diagram 2

Key	
△ plant P	➡ direction of water flow
☆ plant Q	→ direction of wind
● plant R	

(a) Based on the physical characteristics of the three fruits shown, which fruit is likely to be the fruit of plant Q? Put a tick (✓) in the appropriate box.

[1]







(b) Explain your choice in (a).

[2]

---



---



---

(c) Explain why it is important for seeds to be dispersed.

[1]

---



---

(Go on to the next page)

SCORE	4
-------	---

31 The diagram shows the direction of blood flow in some parts of the human body:

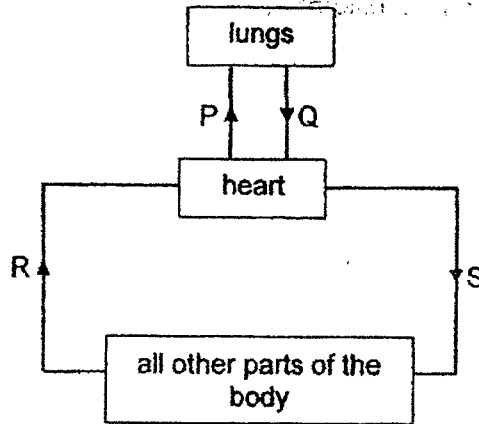

(a) Which arrow, P, Q, R or S, represents the flow of blood that contains the greatest amount of carbon dioxide? Give a reason. [1]

---



---

(Go on to the next page)

SCORE	
-------	--

Continue from question 31

Muthu wanted to find out how his pulse rate would change with different activities. He recorded his pulse rate immediately after each activity in the table.

activity	pulse rate per minute
P	75
Q	85
R	95
S	115

(b) Suggest one variable that Muthu had to keep constant.

[1]

---

(c) Muthu's pulse rate at rest was 65 beats per minute. Explain why his pulse rate increased when doing activity S.

[2]

---



---



---

(Go on to the next page)

SCORE	3
-------	---

32 Jasmine wanted to find out how different coloured lights affect the rate of photosynthesis. She set up a tank as shown in a dark room. She then introduced some fish into each section with the same amount of water plant.

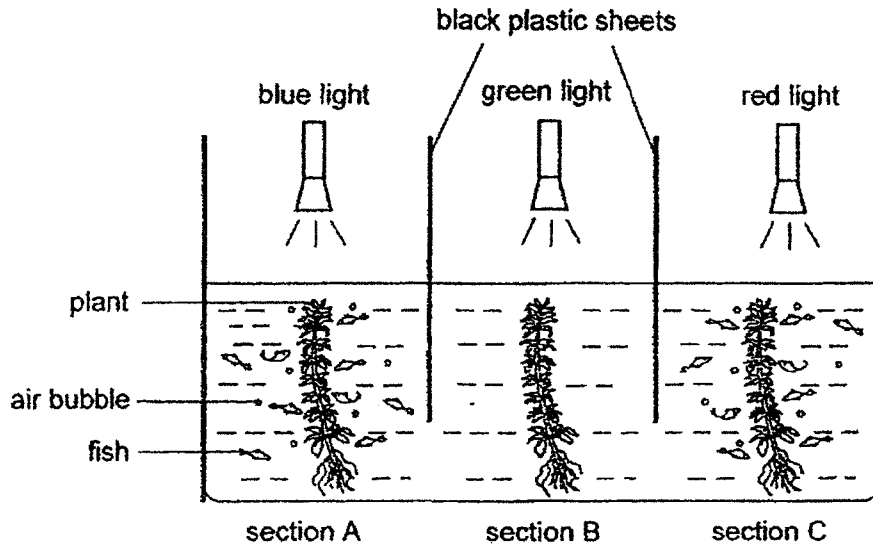

(a) Explain why the fish were found in sections with blue and red lights. [1]

---



---

(b) Which coloured light(s) could be used for photosynthesis? [1]

---

(c) Jasmine's teacher suggested that she repeated her experiment with the same set-up. Why did her teacher say that? [1]

---



---

(Go on to the next page)

SCORE	3
-------	---

Continue from question 32

Jasmine set up another experiment as shown in diagram 1 to find out how the rate of photosynthesis of a plant is affected by light intensity. Diagram 2 shows some bubbles observed in the test tube at the end of the experiment.

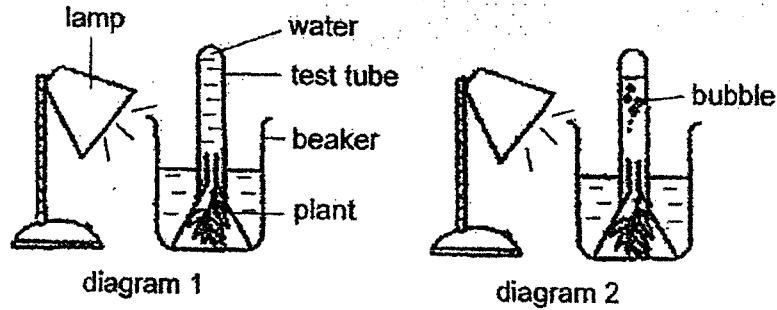

She recorded the number of bubbles produced per minute.

light intensity (units)	number of bubbles produced per minute
10	1
20	3
30	4
40	5
50	6

(d) State the relationship between the light intensity and the rate of photosynthesis. [1]

---



---

(e) Suggest one other change Jasmine could make to the set-up in order to collect more bubbles. [1]

---



---

(Go on to the next page)

SCORE	2
-------	---

33. Huimin placed two similar plants, A and B, in two identical pots containing the same amount of blue-coloured water. She made a 2-cm cut to the stem of plant A and a 1-cm cut to the stem of plant B.

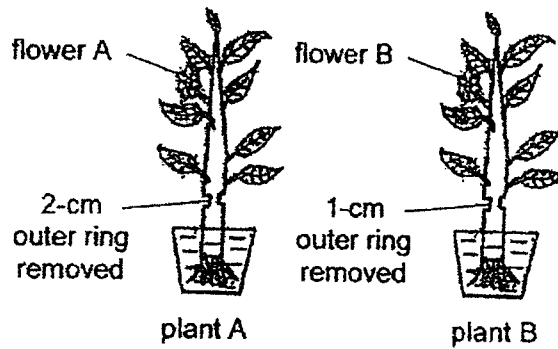
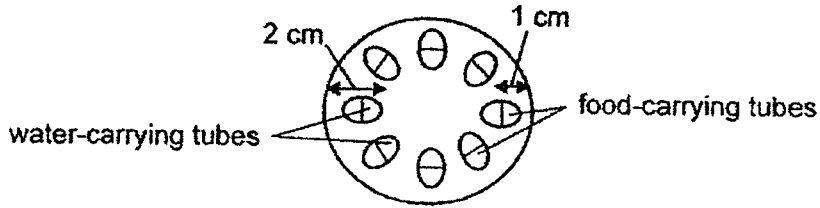

A day later, she noticed flower A remained white while flower B had turned blue.

- (a) Explain why flower A remained white. [1]

---



---

- (b) Huimin also found that the stem below the cut section of plants A and B shrivelled after a few days. Explain why. [1]

---



---

- (c) Suggest a control set-up. [1]

---



---

(Go on to the next page)

SCORE	3
-------	---

34 Chitra conducted an experiment by putting similar blocks of different masses onto three materials, J, K and L.

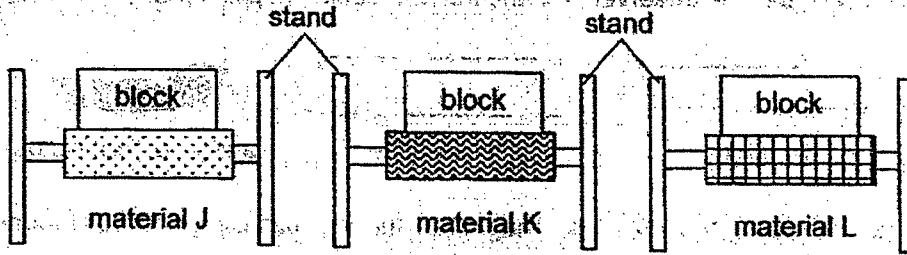

She recorded the mass that each material could hold before it broke in the table as shown.

Material	Mass of blocks each material could hold before it broke (g)
J	1200
K	2600
L	600

(a) State the property that Chitra was testing. [1]

\_\_\_\_\_

(b) Put a tick (✓) in the box(es) below to indicate the changed variable. [1]

variables	changed
type of material	
mass of blocks	
thickness of material	

(c) Which material should Chitra choose to make a chair? Explain why. [1]

\_\_\_\_\_  
 \_\_\_\_\_

(Go on to the next page)

SCORE	3
-------	---

35 Dave was given an iron bar, a bar magnet and a bowl of iron filings as shown. His teacher asked him to pick up the iron filings from the bowl using the iron bar. He observed that the iron bar could not pick up any iron filings.

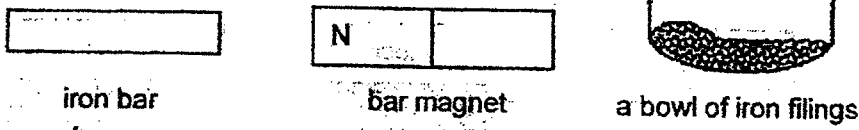

(a) Describe how he could magnetise the iron bar using the bar magnet so that he could pick up the iron filings from the bowl. [2]

---



---



---

(b) Dave then decided to use a glass rod instead of the iron bar for part (a). However, the method could not work. Explain why. [1]

---



---

Next, his teacher gave him object X. She told him to put the bar magnet and object X near to each other. He observed that object X was attracted to the bar magnet as shown in the diagram.

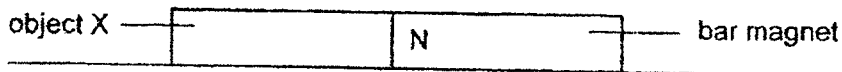

(c) Dave concluded that object X was a magnet. Do you agree with him? Give a reason. [1]

---



---

(Go on to the next page)

SCORE	4
-------	---

36 Junwei placed a balloon into a plastic bottle.

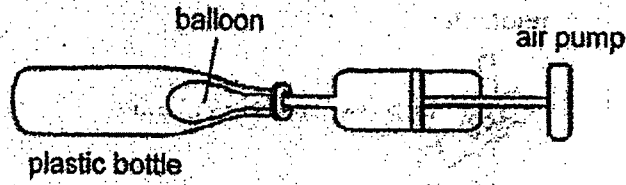

(a) Junwei tried inflating the balloon using the air pump but found it difficult to do so. Explain why. [1]

---



---

(b) Without adding or removing anything in the set-up, what could Junwei do to make it easier for him to inflate the balloon inside the plastic bottle? [1]

---



---

(c) Explain your answer in part (b). [1]

---



---

(Go on to the next page)

SCORE	3
-------	---

37 Study the set-up.

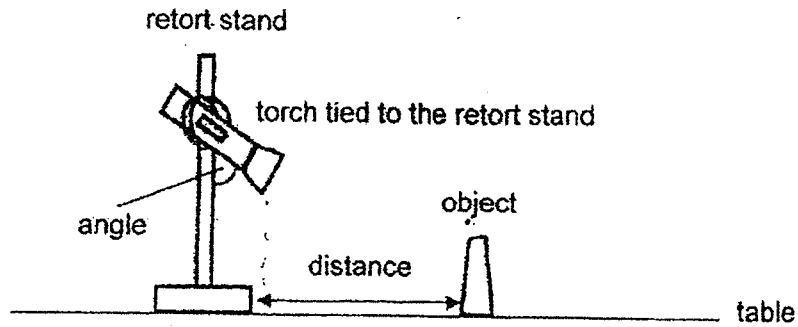

The table shows the results of the experiment.

distance of object from torch (cm)	length of shadow cast on the table (cm)
10	7
20	15
30	22

(a) What was the aim of the experiment? [1]

---



---

(b) Based on the experiment, why was the shadow formed on the table? [1]

---



---

(c) Give a reason how keeping the angle of the torch shining at the object constant make the experiment a fair test [1]

---



---

(Go on to the next page)

SCORE	3
-------	---

38. Ahmad had three rods, A, B and C, made of different materials. When he touched the rods with his hands, rod A felt the coldest, followed by rod C and then rod B.

(a) Give a reason why Ahmad's hand felt cold when he touched the rods. [1]

---



---

Then, Ahmad heated the rods to 90°C. He placed each rod into a beaker of water.

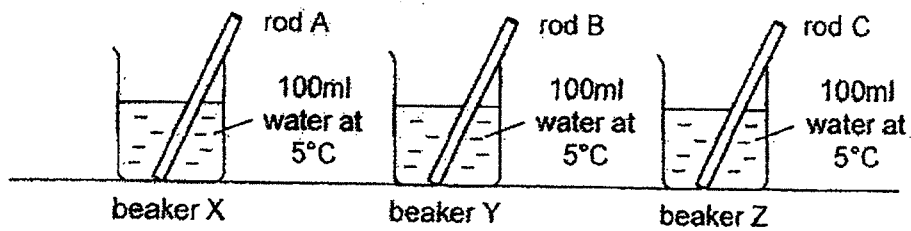

He left the beakers in his room and measured the temperature of water in each beaker over a period of time. The graph shows the results.

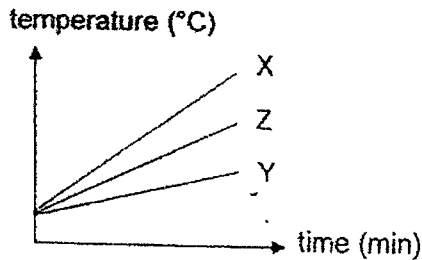

(b) Based on the results, which rod should be placed in a cup of hot tea to cool the tea the fastest? Explain why. [2]

---



---



---

(Go on to the next page)

SCORE	3
-------	---

- 39 Mrs Chen took a freshly-baked cake out of the hot oven and immediately placed it in a glass container as shown.

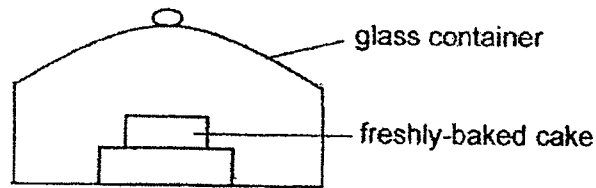

Some water droplets were observed on the inner surface of the glass container a few minutes later.

- (a) Explain how the droplets of water were formed. [2]

---



---



---

Mrs Chen and her daughter then baked another cake and left it to cool in the kitchen for half an hour before putting it in another glass container.

- (b) Compared to part (a), would the amount of water droplets observed on the inner surface of the glass container increase, decrease or remain the same a few minutes after the cake was placed in the glass container? Explain your answer. [1]

---



---

(Go on to the next page)

SCORE	3
-------	---

Continue from question 39

After the baking session, Mrs Chen's daughter washed her hair. Then, she tied her wet hair as shown in diagram 1.

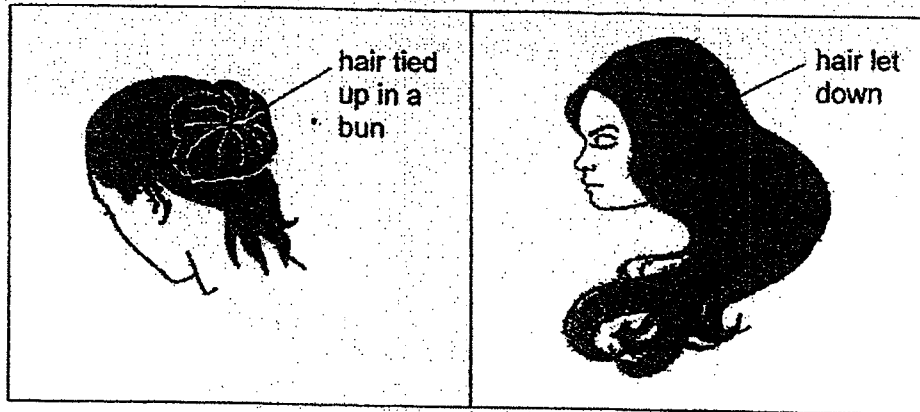

diagram 1

diagram 2

- (c) Mrs Chen told her that her hair would dry faster if she let it down as shown in diagram 2. Do you agree with her mother? Explain why. [1]

---



---

- (d) State another way the daughter could dry her hair faster. [1]

---



---

(Go on to the next page)

SCORE	2
-------	---

- 40 The graphs show the relationship between the number of bulbs and the brightness of the bulbs in circuit A and circuit B. All the bulbs and batteries are identical.

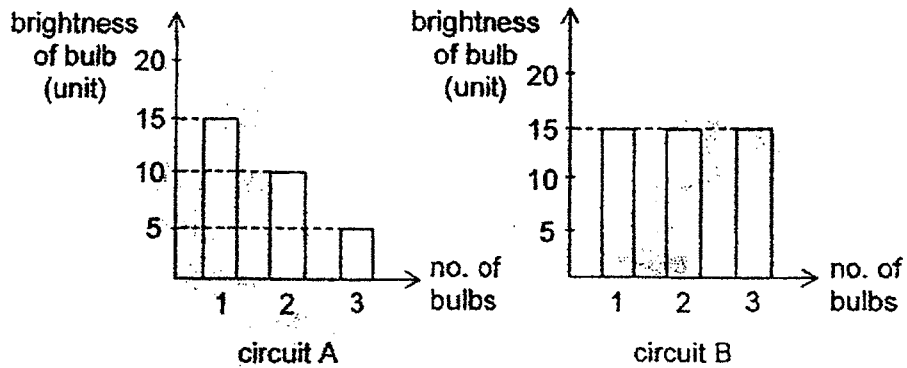

- (a) Based on the above graphs, state the arrangement of the bulbs in each of the circuits. [1]

circuit A: \_\_\_\_\_

circuit B: \_\_\_\_\_

- (b) Complete the circuit diagram of circuit B in the box. The batteries have been drawn for you. [1]

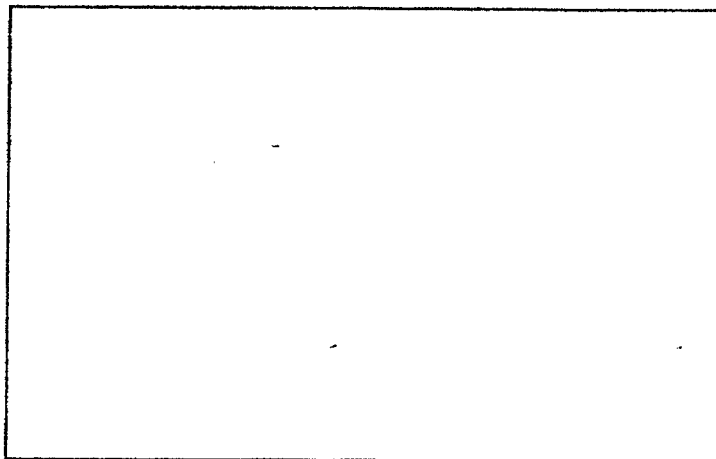

(Go on to the next page)

SCORE	2
-------	---

- 41 Jack made a circuit maze with strips of plastic on a cardboard as shown. The four corners labelled P, Q, R and S were made of aluminium foil.

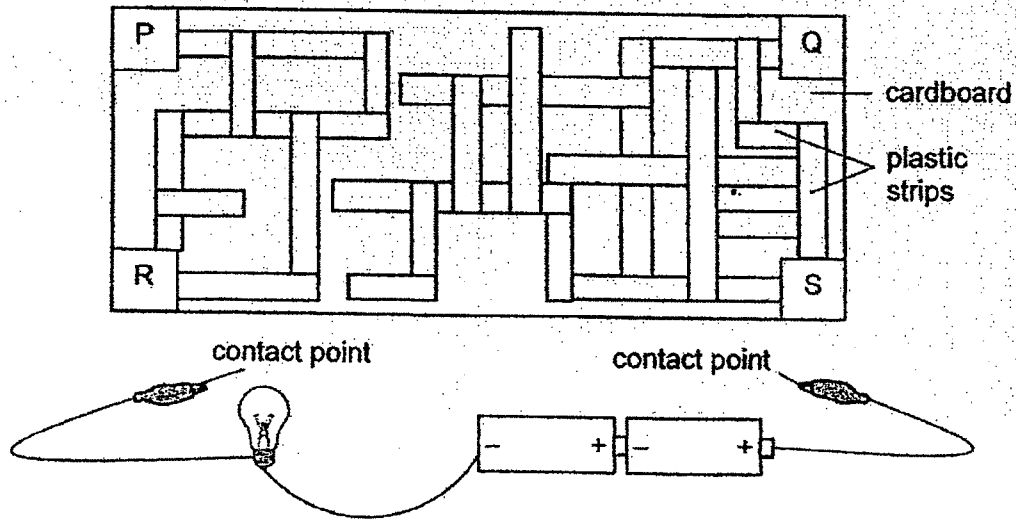

- (a) When Jack clipped the contact points to corners Q and S in the circuit maze, the bulb did not light up. Explain why. [1]

---



---

- (b) Suggest what Jack should do to solve the problem in part (a). [1]

---



---

- (c) Once Jack had solved the problem, he clipped the contact points to corners R and S. He noticed that the bulb still did not light up. Explain why. [1]

---



---

End of Booklet B

SCORE	3
-------	---

1  
2  
3

### ANSWER KEY

**YEAR** : 2022  
**LEVEL** : Primary 5  
**SCHOOL** : Catholic High School (Primary)  
**SUBJECT** : SCIENCE  
**TERM** : End of Year Examination

#### Booklet A

Q1	4	Q2	2	Q3	3	Q4	3	Q5	2
Q6	3	Q7	4	Q8	2	Q9	1	Q10	4
Q11	1	Q12	2	Q13	4	Q14	2	Q15	3
Q16	3	Q17	1	Q18	1	Q19	2	Q20	4
Q21	3	Q22	1	Q23	2	Q24	4	Q25	2
Q26	2	Q27	1	Q28	3				

#### Booklet B

Q29	<p>(a) Animal X has 3-stage life cycle but animal Y has 4-stage life cycle.</p> <p>(b) Pupa stage. The pupa does not eat.</p>
Q30	 <p>(a) <input checked="" type="checkbox"/></p> <p>(b) Fruit Q has hook-like structures that can hook onto the body covering of animals or human clothing. The fruit loosens and drops off when the animal moves to different locations.</p> <p>(c) This is to reduce overcrowding so that the young plants and the adult plant do not compete for sunlight, water, nutrients and space.</p>
Q31	<p>(a) Arrow P. Blood rich in carbon dioxide produced by all parts of the body is transported to the heart and then the lungs to be exhaled.</p> <p>(b) The duration for each activity/the time he took to do for each activity.</p> <p>(c) His heart needs to pump harder to carry blood faster to supply more oxygen and more digested food to various parts of the body to release more energy.</p>
Q32	<p>(a) The plants with blue and red lights could carry out photosynthesis and produced oxygen for the fish.</p>

	<p>(b) blue and red lights</p> <p>(c) To ensure that the results are more reliable.</p> <p>(d) As the light intensity increases, the photosynthesis also increases.</p> <p>(e) – add more water plants - add baking soda where water plant is</p>
Q33	<p>(a) The water-carrying tubes of plant A were removed so the blue-coloured water absorbed by the roots could not be transported to the flower.</p> <p>(b) As the food-carrying tubes were cut off, food made by the leaves could not be transported to the other parts of the plant below the cut/roots.</p> <p>(c) A similar set-up with no cuts on the plant.</p>
Q34	<p>(a) strength</p> <p>(b) tick : type of material</p> <p>(c) Material K. Material K could hold the greatest mass of blocks before it broke so it was the strongest material.</p>
Q35	<p>(a) Stroke the iron bar with one pole of the magnet repeatedly.</p> <p>(b) Glass is a non-magnetic material so it cannot be magnetised.</p> <p>(c) No. There was no repulsion.</p>
Q36	<p>(a) There was air in the bottle and air occupies space.</p> <p>(b) He could poke a hole in the plastic bottle.</p> <p>(c) The air in the bottle could escape from the plastic bottle so that the balloon could take up the space previously occupied by the air in the bottle.</p>
Q37	<p>(a) To find out how the distance of object from the torch affects the length of shadow cast on the table.</p> <p>(b) Light travels in a straight line. The light from the torch was blocked by the object, causing the shadow to be formed on the table.</p> <p>(c) To ensure that the object received the same amount of light.</p>
Q38	<p>(a) Ahmad's hand lost heat to the rods.</p> <p>(b) Rod A. The temperature of water in the beaker increased the fastest so rod A was the best conductor of heat as it conducted the heat away from the hot tea to the rod the fastest.</p>
Q39	<p>(a) The warm water vapour from the cake then came into contact with the cooler inner surface of the glass container, lost heat and condensed to form water droplets.</p> <p>(b) Decrease. Some of the water would have evaporated from the cake so less water vapour could condense</p>

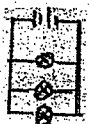
	<p>(c) Yes. The exposed surface area of the wet hair would be greater so the rate of evaporation of water would be faster.</p> <p>(d) She could dry her hair with a dryer.</p>
Q40	<p>(a) Circuit A : series Circuit B : parallel</p>  <p>(b)</p>
Q41	<p>(a) The plastic strips were electrical insulators so there was an open circuit and electric current could not flow through the circuit.</p> <p>(b) Replace the plastic strips with metal strips.</p> <p>(c) The strips were not touching each other, so there is still an open circuit so electric current could not flow through the circuit.</p>

