



**NAN HUA PRIMARY SCHOOL**  
**END OF YEAR EXAMINATION 2022**  
**PRIMARY FIVE**  
**MATHEMATICS**

**PAPER 1**  
**(BOOKLET A)**

**Total Time for Booklets A and B: 1 hour.**

**INSTRUCTIONS TO CANDIDATES**

1. Write your name and index number in the space provided.
2. Do not turn over the page until you are told to do so.
3. Follow all instructions carefully.
4. Answer all questions.
5. Shade your answers in the Optical Answer Sheet (OAS) provided.
6. The use of calculators is **NOT** allowed.

**Name :** \_\_\_\_\_ (            )

**Class :** 5M \_\_\_\_\_

**Date :** 28 October 2022

**Parent's Signature :** \_\_\_\_\_

*This booklet consists of 7 printed pages.*

Questions 1 to 10 carry 1 mark each. Questions 11 to 15 carry 2 marks each.  
For each question, four options are given. One of them is the correct answer.  
Make your choice (1, 2, 3 or 4) and shade your answer on the Optical Answer Sheet.  
(20 marks)

---

- 1 In 527.196, which digit is in the hundredths place?
- (1) 1
  - (2) 5
  - (3) 6
  - (4) 9
- 2 Find the value of  $3 + 4 \times 12 - 8$ .
- (1) 19
  - (2) 28
  - (3) 43
  - (4) 76
- 3 200 students went to a concert. 120 of the students are male. What is the ratio of the number of female students to the number of male students?
- (1) 2:3
  - (2) 2:5
  - (3) 3:2
  - (4) 5:3

4 Find the value of  $0.015 \times 4000$ .

- (1) 0.6
- (2) 6
- (3) 60
- (4) 600

5 A picture is drawn on a square grid.

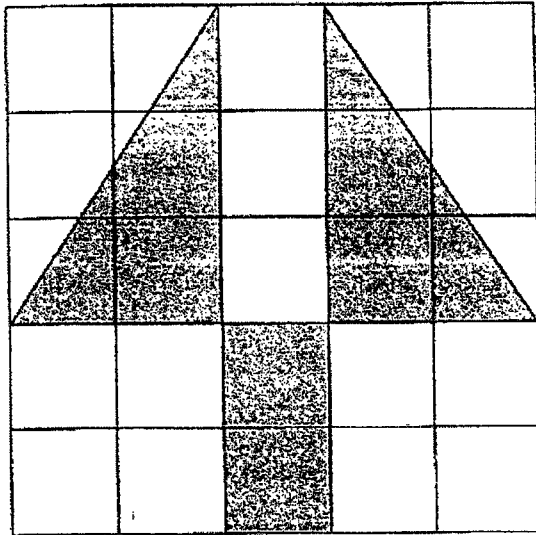

What percentage of the square grid is not shaded?

- (1) 8%
- (2) 17%
- (3) 32%
- (4) 68%

- 6 Bala receives a weekly allowance of \$60. He saves \$12 each week. What percentage of Bala's allowance did he spend?
- (1) 12%
  - (2) 20%
  - (3) 48%
  - (4) 80%
- 7 Mr Tan drove for 4h 35min and reached Malacca at 02 45. What time did Mr Tan start driving?
- (1) 6.20 a.m.
  - (2) 6.20 p.m.
  - (3) 10.10 a.m.
  - (4) 10.10 p.m.
- 8 The table below shows the rate for printing T-shirts at a printing shop.

Quantity	Charge
First 20 T-shirts	\$10 each
Every additional T-shirt	\$8 each

The Book Club printed 50 T-shirts for their 50 members. How much did the club pay for the T-shirts?

- (1) \$250
- (2) \$400
- (3) \$440
- (4) \$500

- 9 The table below shows the number of mistakes some children made in a test.

All	Ben	Calli	Dorothy	Enwel	Faridah
0	4	2	0	3	3

What is the average number of mistakes made by the children in the test?

- (1) 6  
 (2) 2  
 (3) 3  
 (4) 12
- 10 Which statement about the figure below is true?

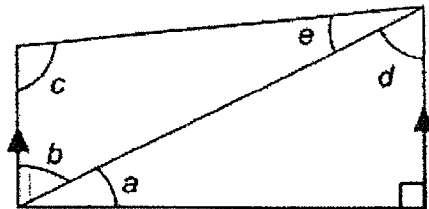

- (1)  $\angle c = 90^\circ$   
 (2)  $\angle a = \angle e$   
 (3)  $\angle c + \angle d + \angle e = 180^\circ$   
 (4)  $\angle a + \angle b + \angle c = 180^\circ$

- 11 Which figure below has the most number of lines of symmetry?

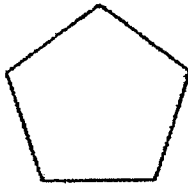

(1)

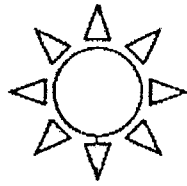

(2)



(3)

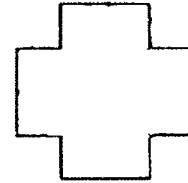

(4)

- 12 Mrs Ng is 45 years old. She is 5 times the age of her son. What is the ratio of Mrs Ng's age to their total age 3 years later?

- (1) 4 : 5
- (2) 5 : 6
- (3) 6 : 7
- (4) 9 : 10

- 13 Aini bought a blouse at \$24 and a skirt that cost twice as much. The amount of money she had left was \$50 when rounded to the nearest \$10. What was the possible amount of money she had at first?

- (1) \$86
- (2) \$90
- (3) \$116
- (4) \$126

- 14 In the figure below, AOB, COD and EOF are straight lines.  $\angle FOD = 52^\circ$ .  
Find  $\angle AOC + \angle BOE$ .

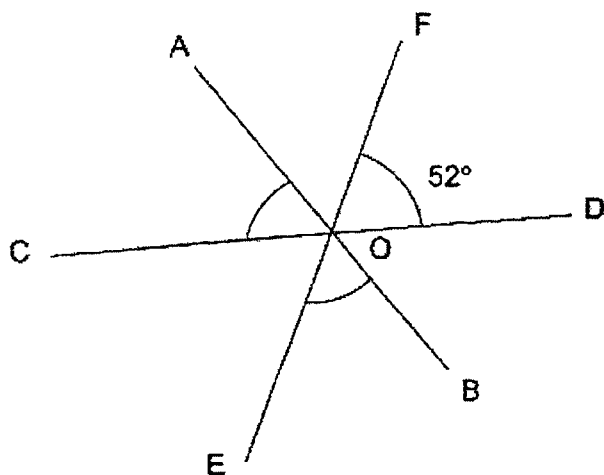

- (1)  $52^\circ$   
(2)  $104^\circ$   
(3)  $128^\circ$   
(4)  $180^\circ$
- 15 Ken started saving some pocket money on Monday. Each day, he saved \$0.30 more than the day before. He saved a total of \$15.50 from Monday to Friday. How much did he save on Tuesday?
- (1) \$2.50  
(2) \$2.80  
(3) \$3.10  
(4) \$3.40





NAN HUA PRIMARY SCHOOL  
 END OF YEAR EXAMINATION 2022  
 PRIMARY FIVE  
 MATHEMATICS

PAPER 1  
 (BOOKLET B)

Total Time for Booklets A and B: 1 hour

**INSTRUCTIONS TO CANDIDATES**

1. Write your name and index number in the space provided.
2. Do not turn over the page until you are told to do so.
3. Follow all instructions carefully.
4. Answer all questions.
5. Write your answers in this booklet.
6. The use of calculators is **NOT** allowed.

**Marks Obtained**

Paper 1	Booklet A		/ 45
	Booklet B		
Paper 2			/ 55
Total			/ 100

Name : \_\_\_\_\_ (                    )

Class : 5M \_\_\_\_\_

Date : 28 October 2022

Parent's Signature: \_\_\_\_\_

*This booklet consists of 11 printed pages.*

Questions 16 to 20 carry 1 mark each. Write your answers in the spaces provided. For questions which require units, give your answers in the units stated.

(5 marks)

Do not write  
in this space

16  $\frac{6}{8} = \frac{\square}{12}$

What is the missing number in the box?

Ans : \_\_\_\_\_

17 Find the value of  $\frac{3}{4} - \frac{1}{8}$ .

Ans : \_\_\_\_\_

18 Susan's mass is 24 kg. Susan's mass is 8 kg less than Karen's mass. Find the ratio of Karen's mass to Susan's mass. Give your answer in its simplest form.

Ans : \_\_\_\_\_

19 At a sale, Mr Samy wanted to buy a television set that cost \$1300 before discount. He was given a 20% discount. How much did Mr Samy have to pay for the television set?

Do not write in this space

Ans : \$ \_\_\_\_\_

20 The box below is filled with some 1-cm cubes. What is the volume of the box?

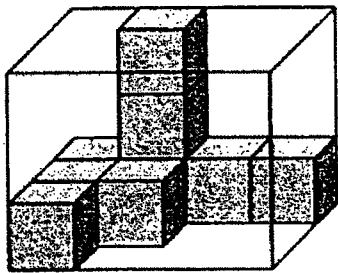

Ans : \_\_\_\_\_ cm<sup>3</sup>

(Go on to the next page)

Questions 21 to 30 carry 2 marks each. Show your working clearly and write your answers in the spaces provided. For question which require units, give your answers in the units stated. (20 marks)

Do not write in this space

21 (a) Arrange these numbers in decreasing order.

14 827, 17 482, 14 278

Ans : (a) \_\_\_\_\_ , \_\_\_\_\_ , \_\_\_\_\_

(b) Round 39 506 to the nearest thousand.

Ans : (b) \_\_\_\_\_

22 (a) A 5 m rope is cut into 9 equal pieces. What is the length of each piece?

Ans : (a) \_\_\_\_\_ m

(b) Express 3006 cm in metres.

Ans : (b) \_\_\_\_\_ m

- 23 (a) Multiply. Express your answer as a fraction in its simplest form.

$$\frac{5}{9} \times \frac{3}{10}$$

Do not write  
in this space

Ans : (a) \_\_\_\_\_

- (b) Express  $\frac{1}{6}$  as a decimal correct to 2 decimal places.

Ans : (b) \_\_\_\_\_



(Go on to the next page)

24 (a) Measure and write down the size of  $\angle ABC$ .

Do not write in this space

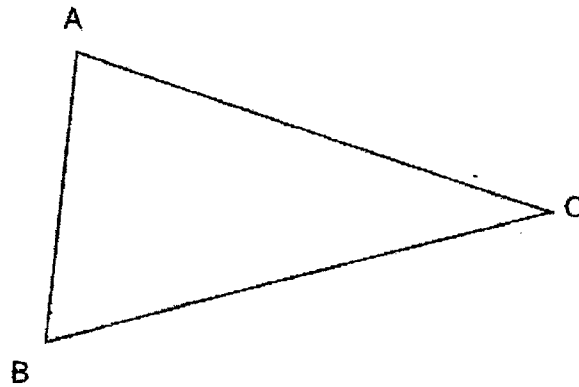

Ans : (a) \_\_\_\_\_ °

The square grid shows the positions of points A, B, C, D, E, F, G and H.

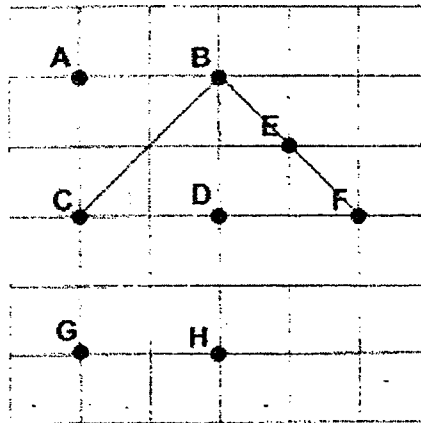

(b) Aini was standing at one of the points facing F. When she turned  $90^\circ$  clockwise, she ended up facing point C. At which point was Aini standing at?

Ans : (b) \_\_\_\_\_



- 25 The table below shows the number of buns sold by a baker on the different days of a week. Some of the data is missing. Fill in the missing data with the information given.

Mon	Tue	Wed	Thu	Fri	Sat	Sun
52	60	43	(a)	65	(b)	72

- (a) The baker sold a total of 267 buns from Monday to Friday. How many buns did he sell on Thursday?

Ans : (a) \_\_\_\_\_

- (b) The average number of buns sold on Saturday and Sunday is 70 buns. How many buns were sold on Saturday?

Ans : (b) \_\_\_\_\_

(Go on to the next page)

Do not write  
in this space

- 26 GHJK is a parallelogram and FGH is an isosceles triangle.  $\angle FHG = 40^\circ$  and  $\angle HJK = 80^\circ$ . Find  $\angle FGK$ .

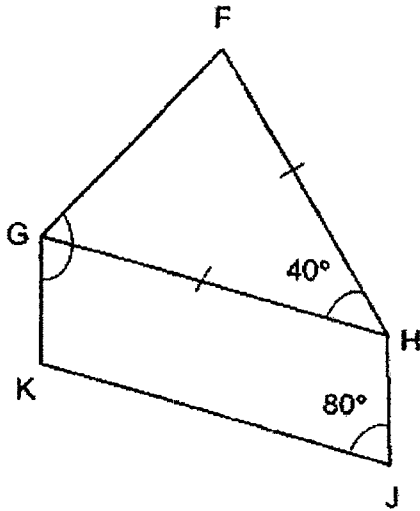

Do not write in this space

Ans : \_\_\_\_\_°

- 27 Draw a cuboid that has half the volume of the cuboid shown on the isometric grid.

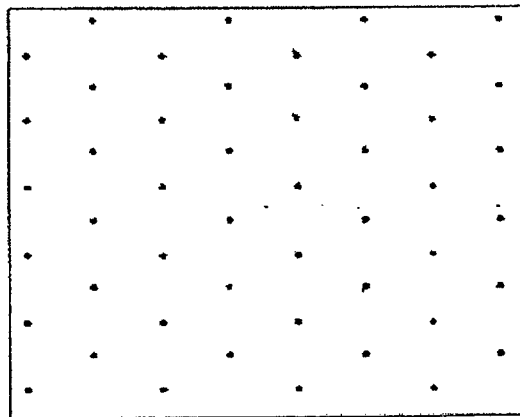
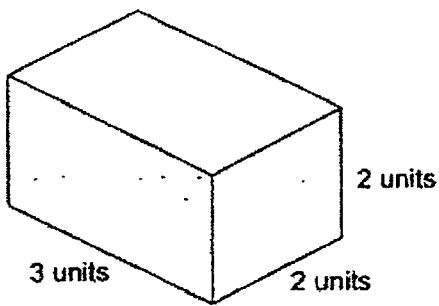

- 28 The figure below is made up of an equilateral triangle, a square and a rectangle. The length of the rectangle is twice its breadth. The area of the square is  $36 \text{ cm}^2$ . Find the perimeter of the figure.

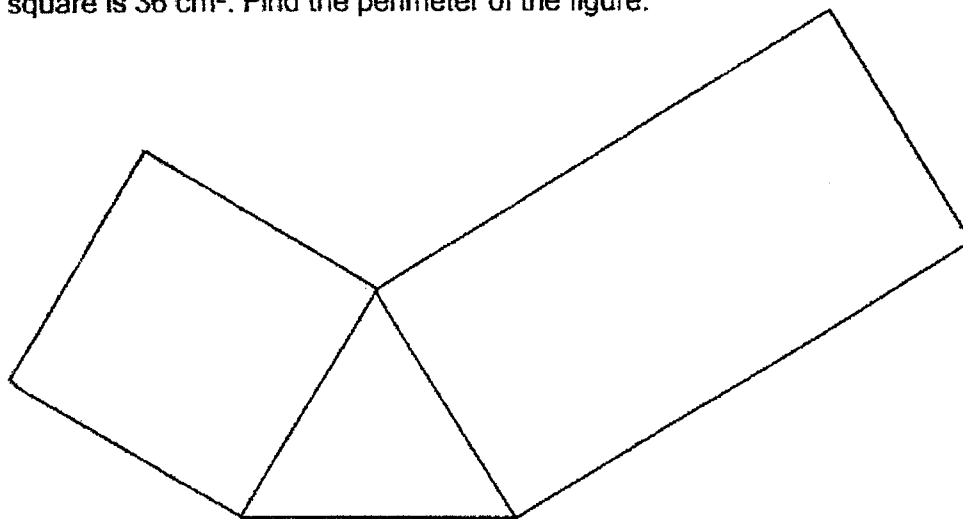

Do not write  
in this space

Ans : \_\_\_\_\_ cm



(Go on to the next page)

- 29 A triangle ABC is drawn on the square grid.

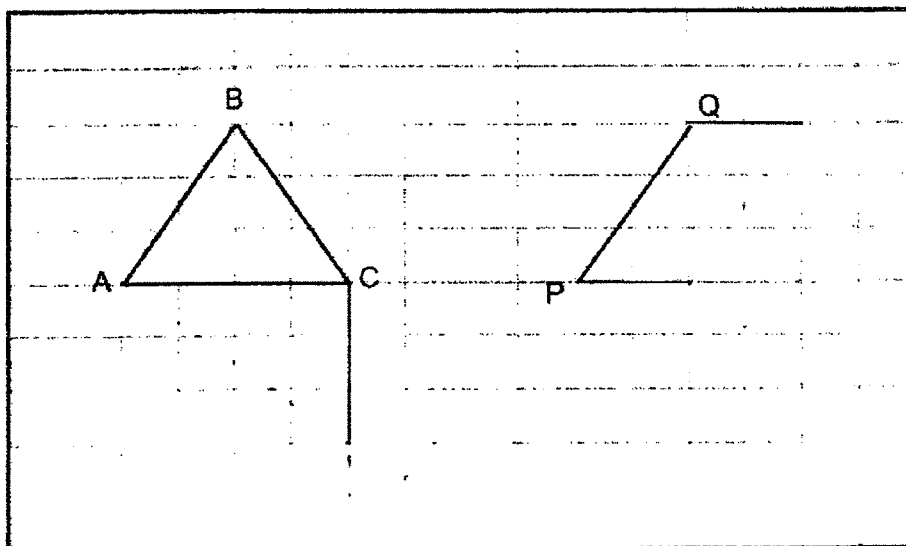

Do not write  
in this space

- (a) Using the line PQ, draw a parallelogram PQRS such that it has the same perimeter as triangle ABC.
- (b) Draw a triangle ADC such that triangle ADC has the same area as triangle ABC and  $\angle ACD = 90^\circ$ .  
Triangle ADC does not overlap triangle ABC.



30 The graphs below show the total number of bottles Machines A and B filled from the start. Both machines started working at the same time.

Do not write in this space

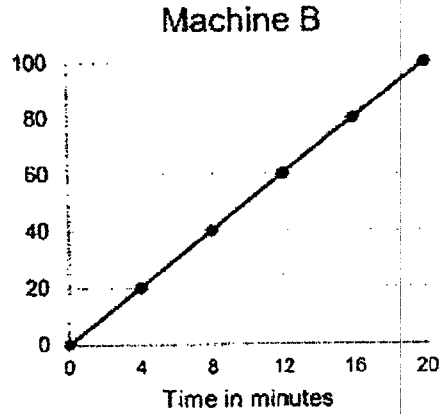
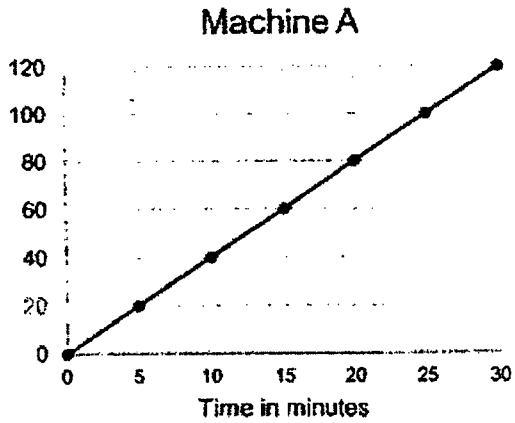

(a) How many more bottles did Machine B fill than Machine A in 10 minutes?

Ans : (a) \_\_\_\_\_

(b) How long will it take for both machines to fill 180 bottles together?

Ans : (b) \_\_\_\_\_ min

End of Paper





**NAN HUA PRIMARY SCHOOL**  
**END OF YEAR EXAMINATION 2022**  
**PRIMARY FIVE**  
**MATHEMATICS**

**PAPER 2**

**Total Time for Paper 2: 1 hour 30 minutes**

**INSTRUCTION TO CANDIDATES**

1. Write your name and index number in the space provided.
2. Do not turn over the page until you are told to do so.
3. Follow all instructions carefully
4. Answer all questions.
5. Write your answers in this booklet.
6. The use of an approved calculator is allowed.

**Marks Obtained**

Total	Max Mark
	55

Name : \_\_\_\_\_ (            )

Class : 5M \_\_\_\_\_

Date : 28 October 2022

Parent's Signature : \_\_\_\_\_

*This booklet consists of 15 printed pages.*

Questions 1 to 5 carry 2 marks each. Show your working clearly and write your answers in the space provided. For questions which require units, give your answers in the units stated. (10 marks)

Do not write in this space

1 What is the sum of all the common factors of 16 and 36?

Ans: \_\_\_\_\_

2 The figure below is made up of 3 triangles.

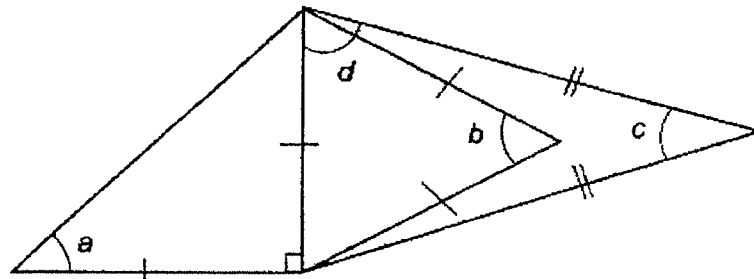

Each of the statements below is either true, false or impossible to tell from the information given. For each statement, put a tick (✓) to indicate your answer.

Statement	True	False	Not possible to tell
$\angle a + \angle b + \angle c$ is less than $180^\circ$ .			
$\angle a + \angle b + \angle d$ is more than $180^\circ$ .			

3

- 3 Joseph spent  $\frac{1}{4}$  of his money on a pair of shoes and  $\frac{1}{2}$  of the remainder on a basketball. He was left with \$84. How much did he spend on the two items?

Do not write  
in this space

Ans: \$ \_\_\_\_\_

- 4 At a party, there were 24 adults. There were 15 more boys than adults. The number of girls was twice the number of adults. Find the ratio of the number of girls to the number of boys to the number of adults in the simplest form.

Ans: \_\_\_\_\_

(Go on to the next page)

4

5 Find the area of the shaded part.

Do not write  
in this space

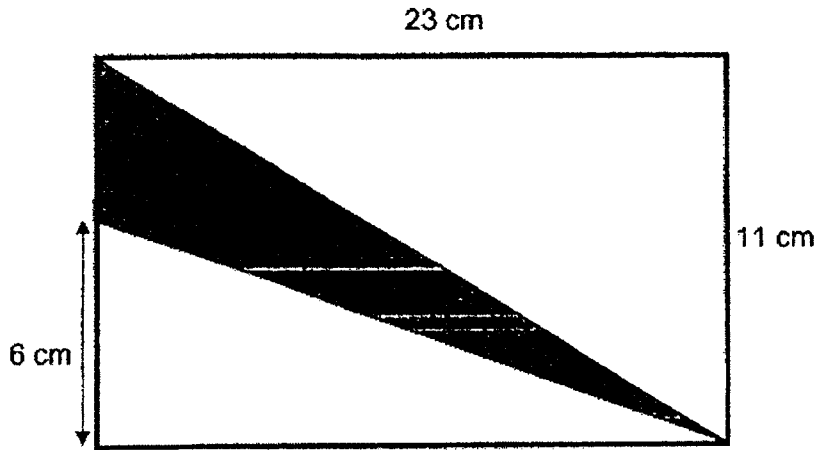

Ans: \_\_\_\_\_ cm<sup>2</sup>

For questions 6 to 17, show your working clearly and write your answers in the spaces provided. The number of marks available is shown in brackets [ ] at the end of each question or part-question. (45 marks)

Do not write  
in this space

- 6 A group of boys had an average of 130 game cards. Another boy with 210 game cards joined the group and the average number of game cards became 150. How many boys were there in the group at first?

Ans: \_\_\_\_\_ [3]

- 7 Mrs Rani borrows \$72 000 from the bank to buy a car. The bank charges 2.8% interest per year. How much interest does Mrs Rani have to pay each month?

Ans: \_\_\_\_\_ [3]

(Go on to the next page)

- 8 In the figure below,  $ABC$  is an isosceles triangle and  $CDEF$  is a rhombus.  $AC = BC$  and  $\angle CFE = 134^\circ$ . Find  $\angle BAC$ .

Do not write  
in this space

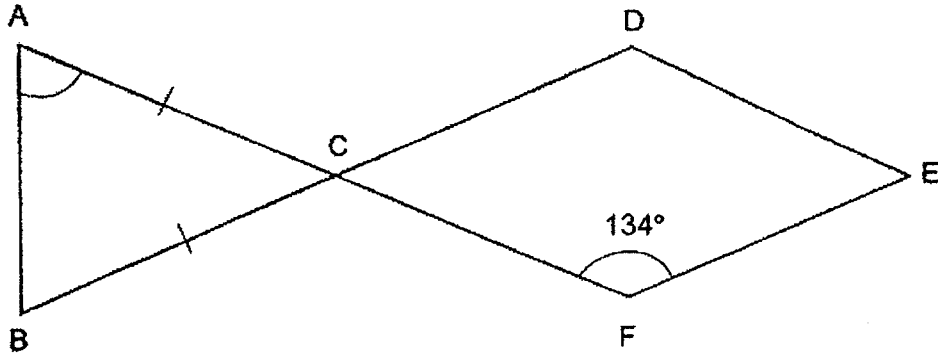

Ans: \_\_\_\_\_ [3]



7

- 9 Container X is a cubical tank of edge 11 cm. It was completely filled with water. The water was then poured into Container Y until it was  $\frac{3}{4}$  full. Do not write in this space

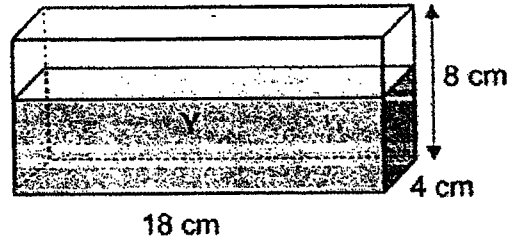
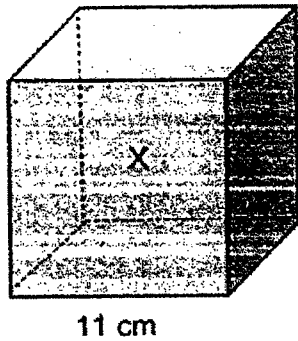

- (a) How much water was there in Container Y?

Ans : (a) \_\_\_\_\_ [1]

- (b) How much water was left in Container X?

Ans: (b) \_\_\_\_\_ [2]



(Go on to the next page)

- 10 At first, a tank was half-filled with water. A tap was turned on for 25 minutes for more water to flow into the tank. It was then turned off. The line graph shows the volume of water in the tank over 25 minutes.

Do not write  
in this space

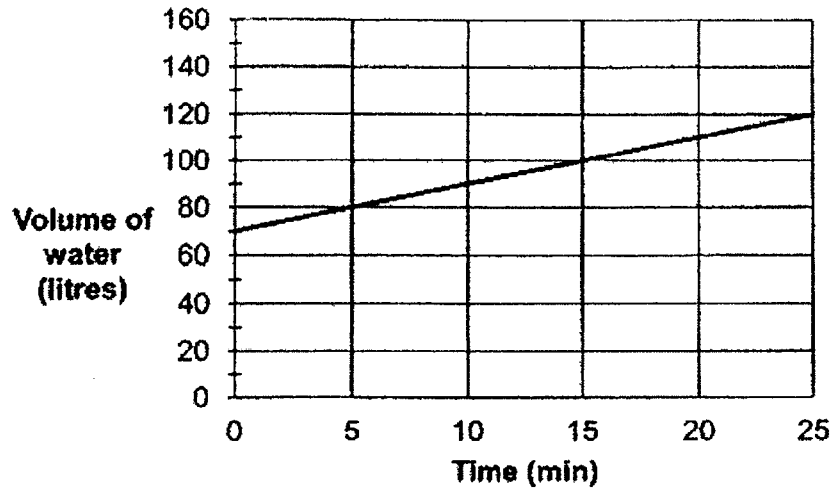

- (a) How many litres of water flowed into the tank in one minute?

Ans : (a) \_\_\_\_\_ [1]

- (b) How many more minutes must the tap be turned on to fill the tank to its brim?

Ans: (b) \_\_\_\_\_ [2]



- 11 In a Mathematics quiz, there were a total of 40 questions. Participants were awarded 4 marks for each correct answer, 1 mark for each question left blank and deducted 2 marks for each wrong answer. Emily left 7 questions blank and scored a total of 103 marks for the quiz. How many questions did she answer correctly.

Do not write  
in this space

Ans: \_\_\_\_\_ [4]

(Go on to the next page)

- 12 Jack had \$9.60 less than Jill at first. After Jill gave some of her money to Jack, he had \$30 more than her. Jack's money became 4 times of Jill's money.

Do not write  
in this space

(a) How much money did they have in all?

Ans : (a) \_\_\_\_\_ [1]

(b) How much money did Jill give Jack?

Ans: (b) \_\_\_\_\_ [3]

- 13 The picture below shows the distance between Mr Ho's house, the library and his office.

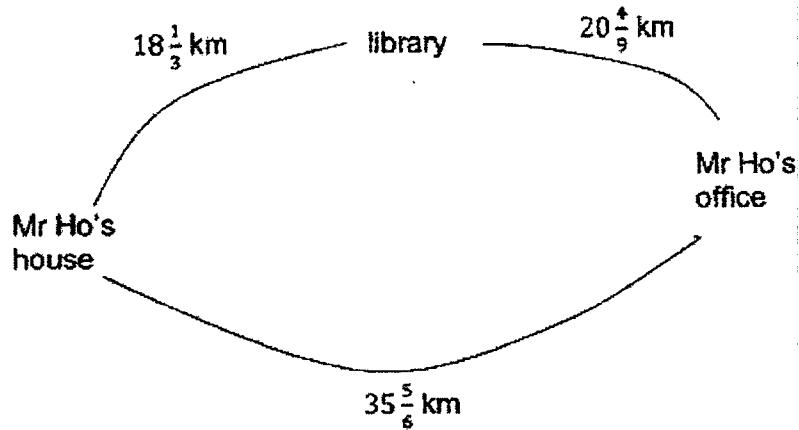

- (a) What is the total distance Mr Ho travels to his office and back home on days that he does not go to the library?

Ans (a) : \_\_\_\_\_ [2]

- (b) On Fridays, Mr Ho stops over at the library on his way home. How much longer does he need to travel on Fridays?

Ans (b) : \_\_\_\_\_ [2]



(Go on to the next page)

14 The bar graph below shows the different coloured shirts sold by a shop in a day.

Do not write in this space

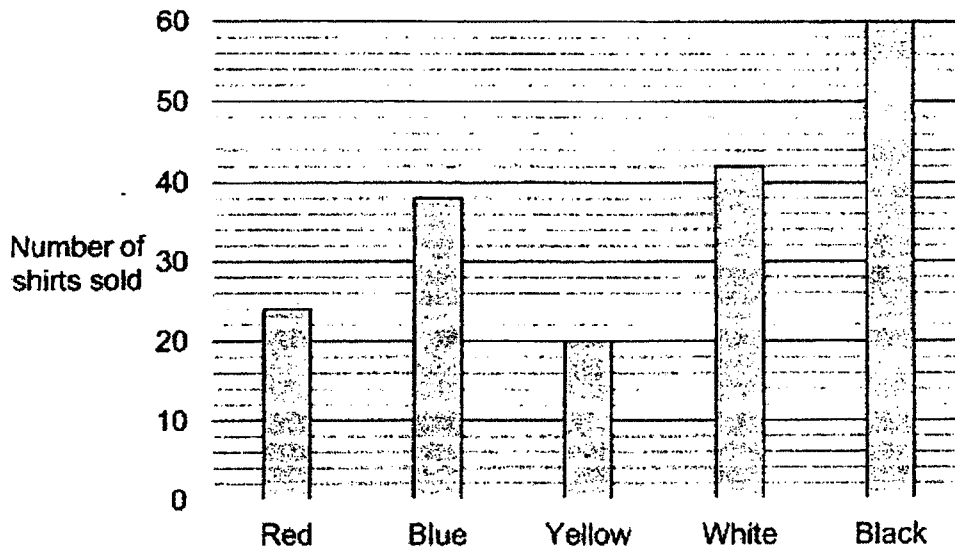

(a) What fraction of the shirts sold were black?  
Leave your answer as the simplest form.

Ans : (a) \_\_\_\_\_ [2]

The table shows the price of the shirts for each colour.

Colour of shirt	Price
Red	\$10
Blue	\$10
Yellow	\$10
White	\$5
Black	\$6

(b) How much did the shop collect from the sale of all the shirts?

Ans : (b) \_\_\_\_\_ [2]



- 15 The figure below shows a square being divided into two smaller squares, A and B and two rectangles, C and D. Do not write in this space

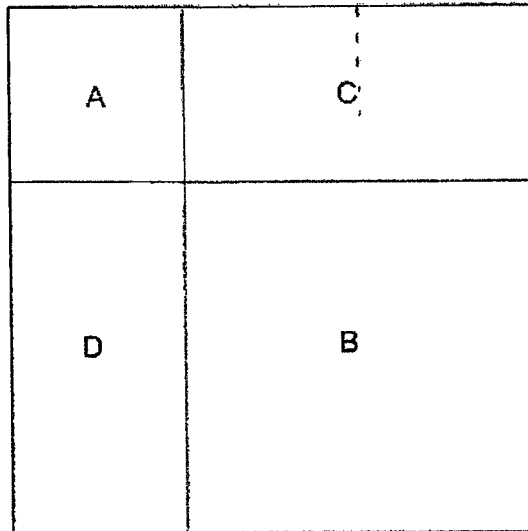

The area of B is 4 times the area of A. The perimeter of D is 62 cm longer than the perimeter of A.

- (a) Find the perimeter of square A.

Ans : (a) \_\_\_\_\_ [2]

- (b) Find the total area of the figure...

Ans : (b) \_\_\_\_\_ [2]



(Go on to the next page)

- 16 Kumar and Larry were paid a total of \$3850 for a job they did. Kumar was paid \$2030 more than Larry.

Do not write  
in this space

(a) How much was Larry paid for the job?

Ans : (a) \_\_\_\_\_ [1]

- (b) Kumar and Larry were paid based on the number of days they worked. Kumar worked 3 times as many days as Larry. Kumar was paid \$5 more than Larry per day. How many days did Kumar work?

Ans : (b) \_\_\_\_\_ [4]

- 17 Kaiwen spent  $\frac{1}{2}$  of her money on 6 cupcakes and 6 cookies. The price of a cookie is  $\frac{1}{3}$  the price of a cupcake. She bought some more cookies with  $\frac{2}{3}$  of her remaining money. How many cookies did she buy altogether?

Do not write  
in this space

Ans: \_\_\_\_\_ [5]

End of Paper



SCHOOL : NAN HUA PRIMARY SCHOOL  
 LEVEL : PRIMARY 5  
 SUBJECT : MATHEMATICS  
 TERM : 2022 SA2

PAPER 1 BOOKLET A

Q 1	Q2	Q3	Q4	Q5	Q6	Q7	Q8	Q9	Q10
4	3	1	3	4	4	4	3	2	3

Q 11	Q12	Q13	Q14	Q15
2	1	4	3	2

PAPER 1 BOOKLET B

Q16)	9	
Q17)	$\frac{5}{8}$	
Q18)	4 : 3	
Q19)	$\$1300 \times 0.20 = \$260$ $\$1300 - \$260 = \$1040$	
Q20)	$3 \times 4 \times 3 = 36\text{cm}^3$	
Q21)	a) 17482 , 14827 , 14278 b) 40000	
Q22)	a) $\frac{5}{9}$ m b) $3006 \div 100 = 30.06\text{m}$	
Q23)	a) $\frac{1}{6}$ b) 0.17	
Q24)	a) $70^\circ$ b) B	
Q25)	a) $267 - 52 - 60 - 43 - 65 = 267 - 220$ $= 47$	

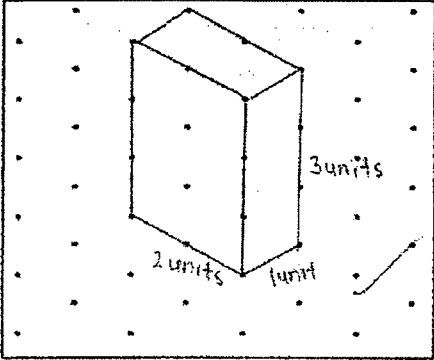
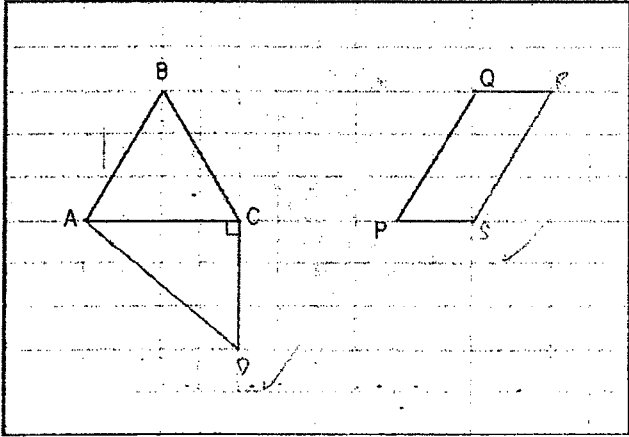
	<p>b) <math>70 \times 2 = 140</math>  <math>140 - 72 = 68</math></p>
Q26)	<p><math>180^\circ - 40^\circ = 140^\circ</math>  <math>140^\circ \div 2 = 70^\circ</math>  <math>70^\circ + 80^\circ = 150^\circ</math></p>
Q27)	<p><math>3 \times 2 \times 2 = 12</math>  <math>12 \div 2 = 6</math></p> 
Q28)	<p><math>6\text{cm} + 6\text{cm} + 6\text{cm} + 6\text{cm} + 12\text{cm} + 6\text{cm} + 12\text{cm} = 30\text{cm} + 24\text{cm}</math>  <math>= 54\text{cm}</math></p>
Q29)	
Q30)	<p>a) <math>20 \div 4 = 5</math>  <math>10 \times 5 = 50</math>  <math>50 - 40 = 10</math></p> <p>b) A: <math>20 \div 5 = 4</math>  B: <math>20 \div 4 = 5</math></p> <p>Total: <math>4 + 5 = 9</math> bottles in 1 min  <math>180 \div 9 = 20\text{min}</math></p>

PAPER 2

Q1)	16: ①, ②, ④, 8 36: ①, ②, 3, ④, 6, 9 $1 + 2 + 4 = 7$							
Q2)	<table border="1" style="margin-left: auto; margin-right: auto;"> <tbody> <tr> <td style="text-align: center;">√</td> <td></td> <td></td> </tr> <tr> <td></td> <td></td> <td style="text-align: center;">√</td> </tr> </tbody> </table>	√					√	
√								
		√						
Q3)	$1.5u = \$84$ $1u = \$56$ $1u + 1.5u = 2.5u$ $2.5u = \$56 \times 2.5$ $= \$140$							
Q4)	16 : 13 : 8							
Q5)	Total Area: $23 \times 11 = 253$ Part 1: $\frac{23 \times 11}{2} = 126.5$ Part 2: $(6 \times 23) \div 2 = 69$ Part 3: $253 - 126.5 - 69 = 57.5\text{cm}^2$							
Q6)	$130X + 210 = 150(X + 1)$ $130X + 210 = 150X + 150$ $20X = 60$ $X = 3$							
Q7)	$\$72000 \times 2.8\% = \$2016$ $\$2016 \div 12 = \$168$							
Q8)	$360^\circ - 134^\circ = 92^\circ$ $92^\circ \div 2 = 46^\circ$ <i>&lt; DCF is opposite angles to &lt; ACB</i> $180^\circ - 46^\circ = 134^\circ$ $134^\circ \div 2 = 67^\circ$							
Q9)	a) $18 \times 4 \times 8 = 576$ $576 \times \frac{3}{4} = 432\text{cm}^3$ b) $11 \times 11 \times 11 = 1331$ $1331 - 432 = 899\text{ml}$							

Q10)	<p>a) <math>80\ell - 70\ell = 10\ell</math>  <math>10\ell \div 5 = 2\ell</math></p> <p>b) <math>70 \times 2 = 140</math>  <math>140 - 120 = 20</math>  <math>20 \div 2 = 10\text{minutes}</math></p>
Q11)	<p><math>7 \times 1 = 7</math>  <math>103 - 7 = 96</math>  <math>40 - 7 = 33</math></p> <p>Assume she scored all the 33 questions correctly  <math>33 \times 4 = 132</math>  <math>4 \rightarrow -2</math>  Diff: <math>4 + 2 = 6</math>  <math>132 - 96 = 36</math>  <math>36 \div 6 = 6</math>  <math>33 - 6 = 27</math> questions</p>
Q12)	<p>a) <math>3u = \\$30</math>  <math>1u = \\$10</math>  <math>5u = \\$50</math></p> <p>b) <math>4u = \\$10 \times 4 = \\$40</math>  <math>\\$40 - \\$20.20 = \\$19.80</math></p>
Q13)	<p>a) <math>35\frac{5}{6}\text{km} + 35\frac{5}{6}\text{km} = 71\frac{2}{3}\text{km}</math></p> <p>b) <math>74\frac{11}{18} - 71\frac{2}{3} = 74\frac{11}{18} - 71\frac{12}{18} = 2\frac{17}{18}\text{km}</math></p>
Q14)	<p>a) <math>24 + 38 + 20 + 42 + 60 = 184</math>  <math>\frac{60}{184} = \frac{30}{92} = \frac{15}{46}</math></p> <p>b) <math>24 \times \\$10 + 38 \times \\$10 + 20 \times \\$10 + 42 \times \\$5 + 60 \times \\$6 = \\$1390</math></p>
Q15)	<p>a) Assume on side of square A as X: <math>X + 2X = X + X + 31</math>  <math>3X = 2X + 31</math>  <math>X = 31</math>  <math>31 \times 4 = 124\text{cm}</math></p> <p>b) <math>2X + 1X = 3X</math>  <math>3X = 31 \times 3 = 93</math>  <math>93 \times 93 = 8649\text{cm}^2</math></p>
Q16)	<p>a) <math>\\$3850 - \\$2030 = \\$1820</math>  <math>\\$1820 \div 2 = \\$910</math></p>

	<p>b) L: 1u days = \$910        K: 3u days = \$910 + \$2030 = \$2940        1u days = \$2940 ÷ 3 = \$980        * Diff K - L in        1u days = \$980 - \$910        = \$70        1u = \$70 ÷ 5 = 14        K worked 3u days = 3 x 14 = 42days</p>
Q17)	<p><math>1 - \frac{1}{2} = \frac{1}{2}</math>  <math>\frac{1}{2} \times \frac{2}{3} = \frac{1}{3}</math>        Assume she had X dollars at first        6 cupcake + 6 cookies = <math>\frac{1}{2}X</math> --- ①        3 cookies = 1 cupcake --- ②        ② x 2 : 6 cookies = 2 cupcakes - ②'        sub ②' into ①:        6 cupcakes + 2 cupcakes = <math>\frac{1}{2}X</math>        8 cupcakes = <math>\frac{1}{2}X</math>        1 cupcakes = <math>\frac{1}{16}X</math>        sub this into ② :        3 cookies = <math>\frac{1}{16}X</math>        1 cookies = <math>\frac{1}{48}X</math>  <math>\frac{1}{3} \div \frac{1}{48} = 16</math>        16 + 6 = 22</p>

