



MARIS STELLA HIGH SCHOOL (PRIMARY)

END-OF-YEAR EXAMINATION

SCIENCE

1 NOVEMBER 2022

BOOKLET A

NAME: _____ ()

CLASS: Primary 4 ()

28 questions

56 marks

Total Time for Booklets A & B: 1 h 45 min

DO NOT OPEN THIS BOOKLET UNTIL YOU ARE TOLD TO DO SO.

FOLLOW ALL INSTRUCTIONS CAREFULLY.

For each question from 1 to 28, four options are given. One of them is the correct answer. Make your choice (1, 2, 3 or 4). Shade the correct oval (1, 2, 3 or 4) on the Optical Answer Sheet (OAS). (56 marks)

- 1 A snail hides itself in its shell when touched.

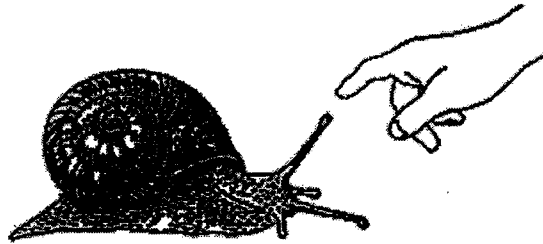

This shows that the snail is a living thing because it can _____.

- (1) grow
 - (2) breathe
 - (3) respond
 - (4) reproduce
- 2 Which of the animals shown below is not an insect?

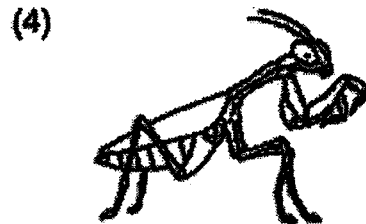
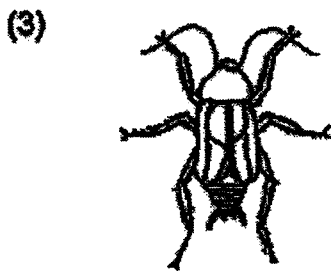
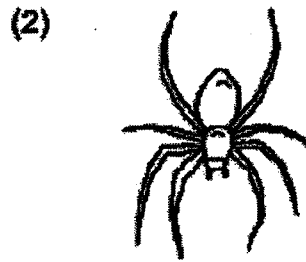

3 Study the classification chart below.

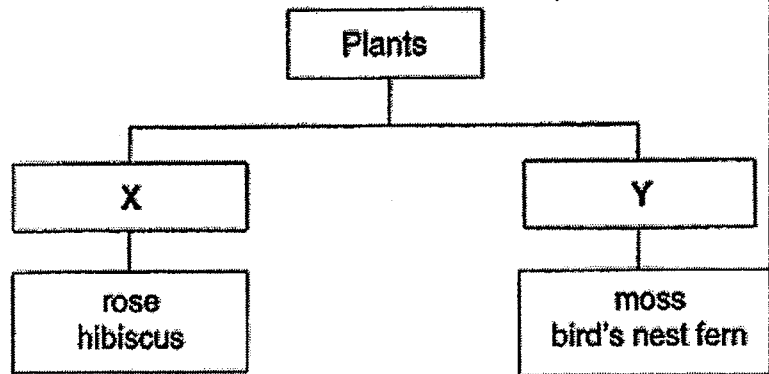

What would a suitable heading for X and Y be?

	X	Y
(1)	cannot make its own food	can make its own food
(2)	can make its own food	cannot make its own food
(3)	flowering plants	non-flowering plants
(4)	non-flowering plants	flowering plants

4 Which of the following statements is correct about all bacteria?

- (1) They cause illnesses.
- (2) They are microscopic.
- (3) They are non-living things.
- (4) They make their own food.

5 Which of the following is true about most amphibians?

- (1) They have wings.
- (2) They give birth to young alive.
- (3) They can live on land and in water.
- (4) They have scales as their outer covering.

6 Jeremy made the following observations on the life cycle of an animal.

- The young looks like the adult.
- There are 3 stages in its life cycle.

Which animal was Jeremy likely to have observed?

- (1) frog
- (2) butterfly
- (3) mosquito
- (4) grasshopper

7 Which of the following represents the life cycle of a beetle?

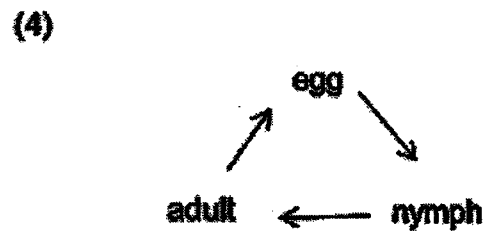
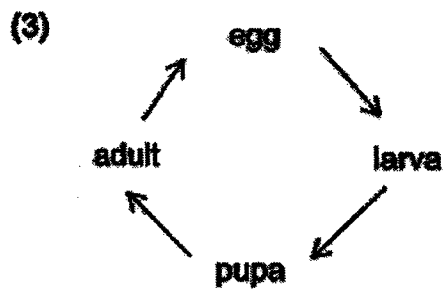
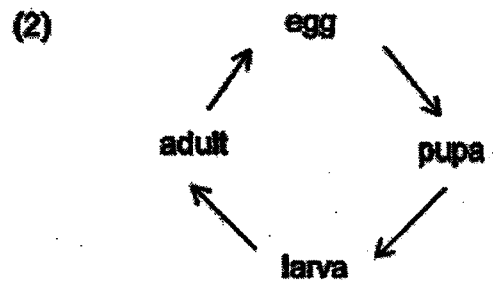
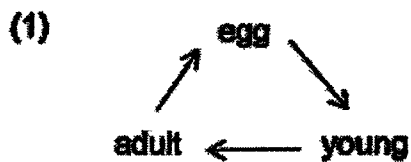

8 The diagram below shows the growth of a young plant with two missing stages A and B.

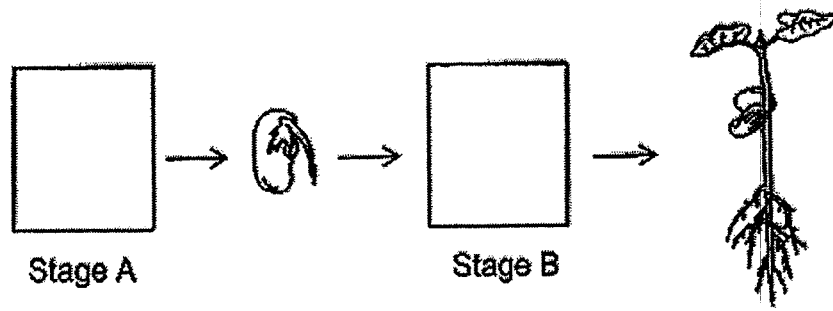

Which one of the following shows the correct stages for A and B?

	Stage A	Stage B
(1)		
(2)		
(3)		
(4)		

9 The diagram below shows a plant.

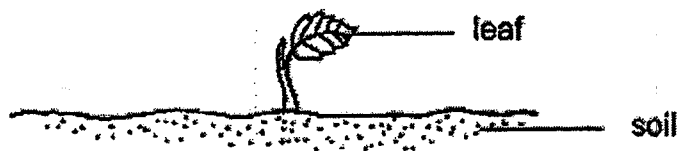

The leaf helps the plant to _____

- (1) make food
- (2) grow upright
- (3) absorb water
- (4) anchor to the soil

10 Study the diagram below. X and Y represent substances that move from the small intestine to different parts of the body.



What do X and Y represent in the above diagram?

	X	Y
(1)	digested food	digested food
(2)	undigested food	undigested food
(3)	undigested food	digested food
(4)	digested food	undigested food

11 Which human system protects the lungs and heart in our body?

(1)

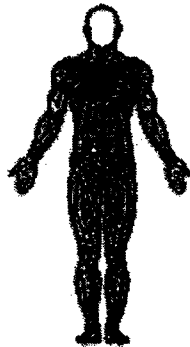

(2)

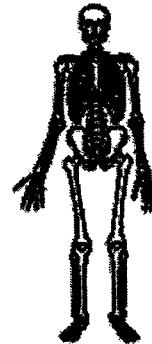

(3)

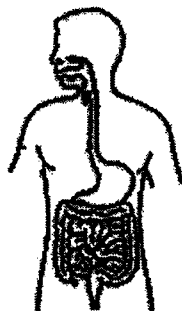

(4)

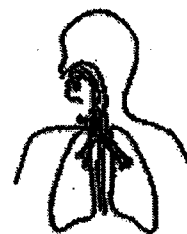

12 Study the classification table below.

S	T	U
tracing paper frosted glass	milk carton textbook	glass window spectacles lens

The objects above have been classified according to their _____.

- (1) strength
- (2) flexibility
- (3) transparency
- (4) ability to absorb water

13 Four balls made of materials, A, B, C and D, were placed in a beaker of water as shown below.

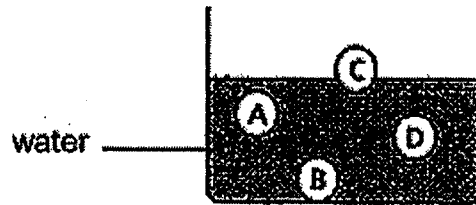

The picture below shows a lifebuoy used to rescue a person from drowning.

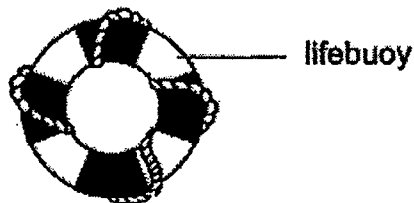

Which of the materials will be most suitable for making a lifebuoy?

- (1) A
- (2) B
- (3) C
- (4) D

14 Which one of the following objects can be bent easily without breaking?

(1) a glass sheet



(2) a ceramic spoon



(3) a wooden ruler



(4) a fabric towel



15 Study the diagram below.

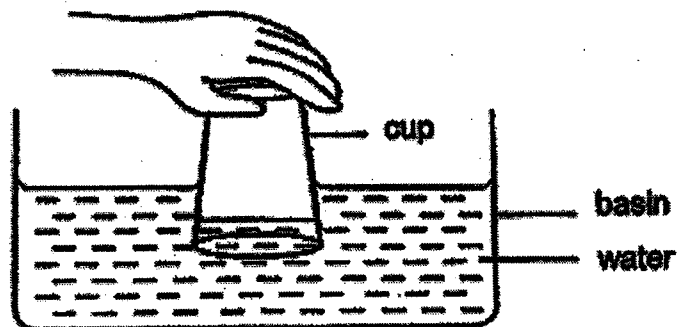

The water level is lower in the cup than in the basin because _____.

- (1) air cannot be compressed
- (2) air in the cup takes up space
- (3) water does not have a definite shape
- (4) water does not have a definite volume

16 Which of the following item(s) makes use of magnets to work?

- A compass
- B storybook
- C canned drink

- (1) A only
- (2) A and C only
- (3) B and C only
- (4) A, B and C

17 Kieran wants to measure the volume of a 5 g marble.

Which apparatus should he use for to measure the volume accurately?

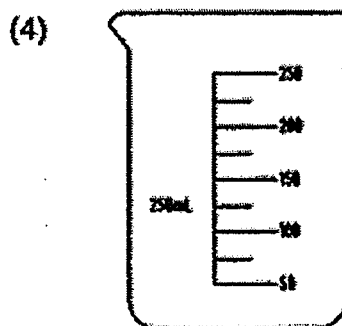
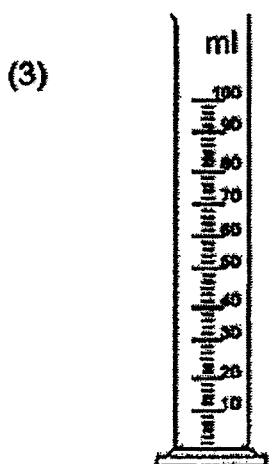
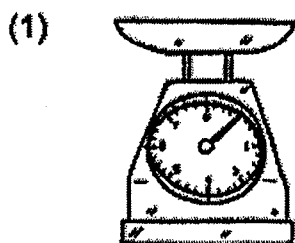

- 18 Which of the following similarities is correct for both air and a pencil?
- (1) They take up space.
 - (2) They do not have mass.
 - (3) They have fixed volumes.
 - (4) They have definite shapes.
- 19 Using the stroking method, two iron bars are made into temporary magnets using either one or two magnets as shown in the diagrams below.

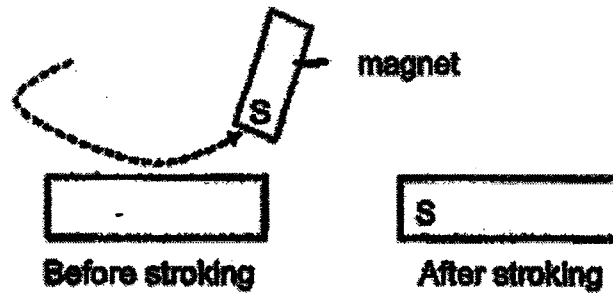

Diagram 1: Using one magnet

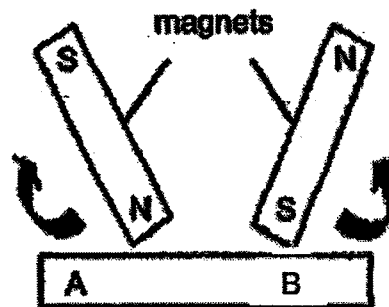
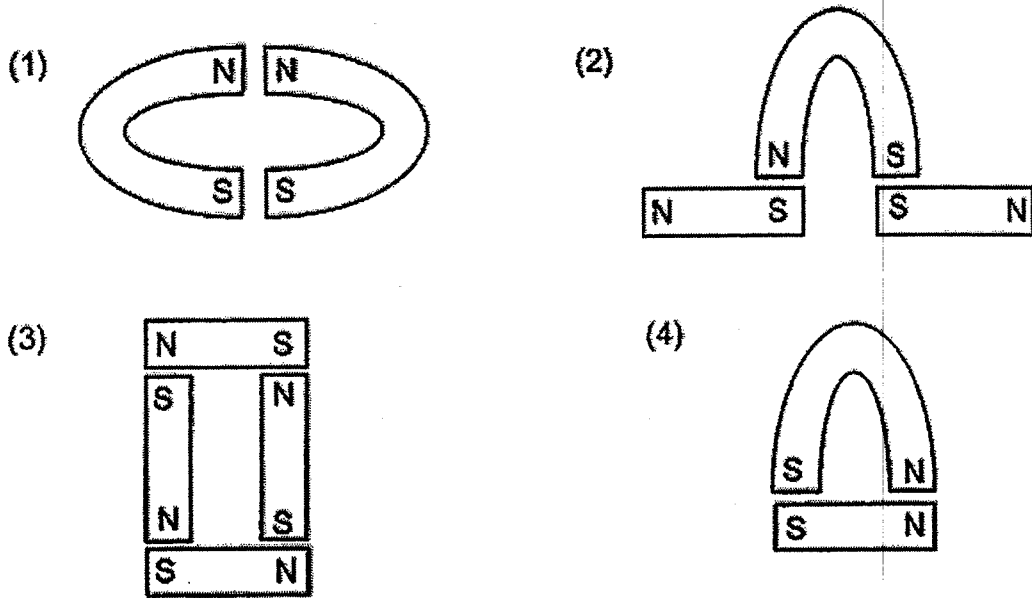

Diagram 2: Using two magnets

Which one of the following correctly shows the poles at A and B in Diagram 2?

	A	B
(1)	N-pole	N-pole
(2)	N-pole	S-pole
(3)	S-pole	N-pole
(4)	S-pole	S-pole

20 In which arrangement will all the magnets pull towards each other?



21 Bars X, Y and Z were hung equal distance from each other as shown.

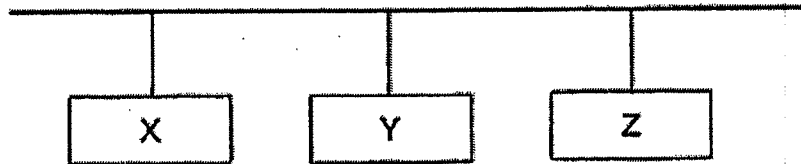

When bar X was slightly pushed, the observation below was made.

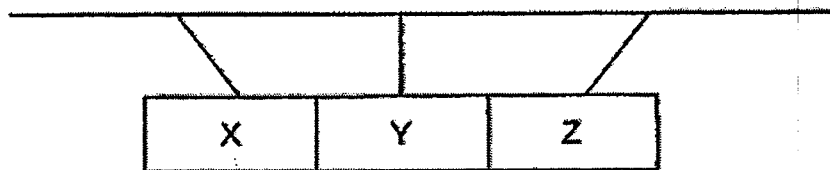

Which statements are possibly correct?

- A All three bars are magnets.
- B Bars X and Z are magnets while bar Y is magnetic.
- C Bar Y is a magnet while X and Z are non-magnetic.
- D Bar X is non-magnetic, Y is magnetic and Z is a magnet.

- (1) A and B only
- (2) B and C only
- (3) C and D only
- (4) A and D only

- 22 Three different sheets of material, X, Y and Z, are individually placed between a light source and a light sensor as shown.



The amount of light detected by the light sensor is shown in the table below.

Material	Amount of light detected (unit)
X	500
Y	120
Z	0

Which of the following statements is correct?

- (1) Material Z is opaque.
 - (2) Materials X and Y are transparent.
 - (3) Material Z allows most light to pass through.
 - (4) Material Y allows more light to pass through it than material X.
- 23 Galen set up an experiment as shown below.

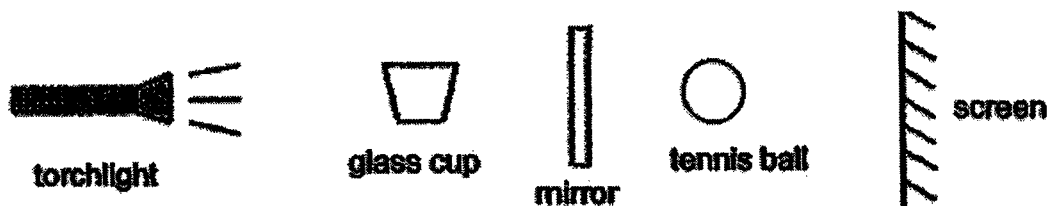

Which of the following shadows would be formed on the screen?

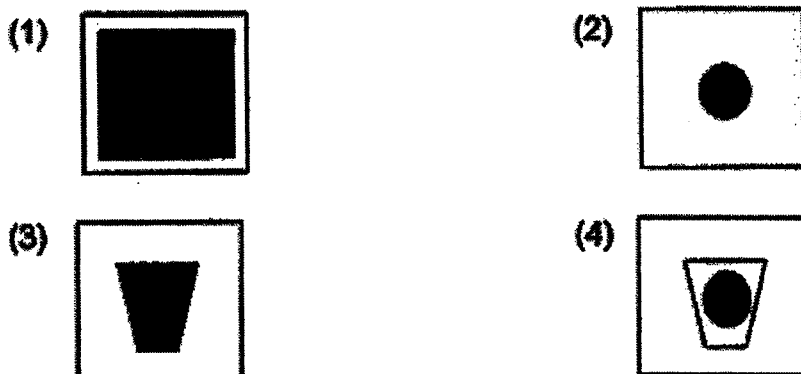

24 Look at the picture below.

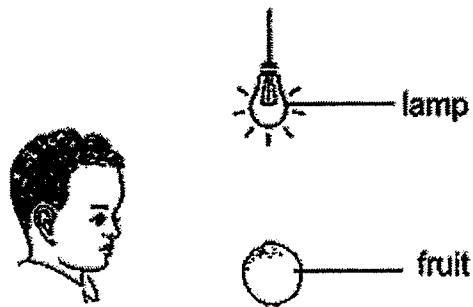

Which of the following explains why the boy can see the fruit in a dark room?

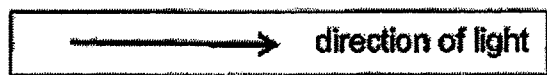

(1)

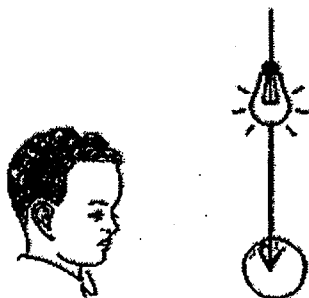

(2)

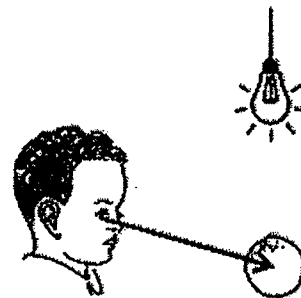

(3)

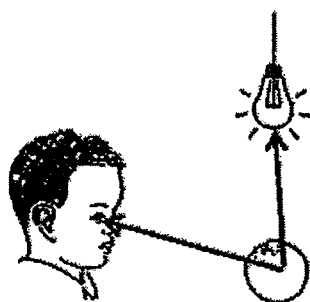

(4)

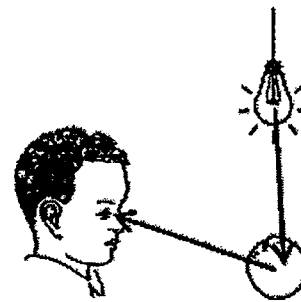

25 Jia Ming wants to measure the temperature of water in a beaker.

Which of the following diagrams shows the correct position of the thermometer when taking the temperature reading?

(1)

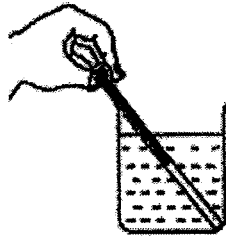

(2)

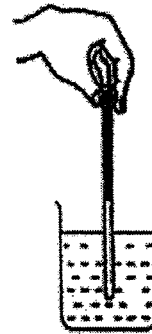

(3)



(4)



26 Two identical cups were filled with equal amount of water at different temperatures. After pouring all the water from cup A to cup B, the temperature of water in B was measured immediately.

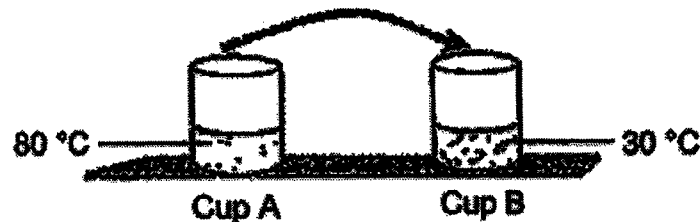

What is the temperature of the water measured in cup B after all the water in cup A was poured into cup B?

- (1) 30 °C
- (2) 50 °C
- (3) 80 °C
- (4) 110 °C

27 Which one of the following is a source of heat?

- (1) the Sun
- (2) a sweater
- (3) a woollen cap
- (4) a wooden block

28 Michael heated a beaker of water using a Bunsen burner as shown. He recorded the change in temperature of the water over a period of time in the graph below.

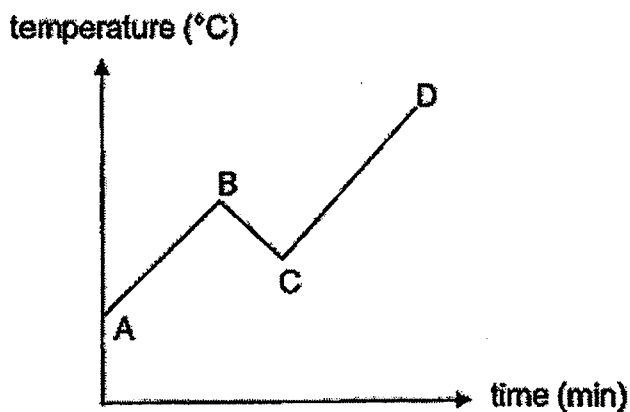
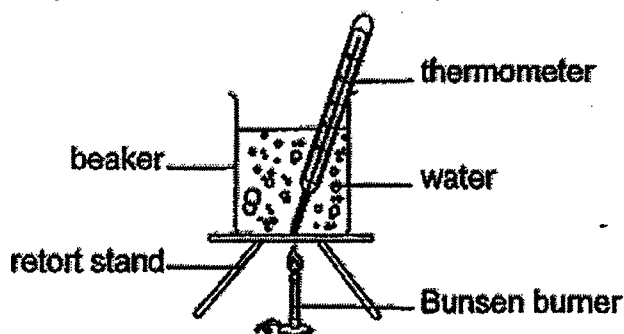

During the time the water was heated, Michael removed the Bunsen burner for a short while before he continued heating it.

At which point on the graph was the Bunsen burner removed?

- (1) A
- (2) B
- (3) C
- (4) D

End of Booklet A



MARIS STELLA HIGH SCHOOL (PRIMARY)

END-OF-YEAR EXAMINATION

SCIENCE

1 NOVEMBER 2022

BOOKLET B

NAME: _____ ()

CLASS: Primary 4 ()

12 questions

44 marks

Total Time for Booklets A & B: 1 h 45 min

DO NOT OPEN THIS BOOKLET UNTIL YOU ARE TOLD TO DO SO.

FOLLOW ALL INSTRUCTIONS CAREFULLY.

Booklet A: _____ / 56

Booklet B: _____ / 44

Grand Total: _____ / 100

Parent's Signature: _____

For questions 29 to 40, write your answers in this booklet. The number of marks available is shown in brackets [] at the end of each question or part question.

(44 marks)

- 29 Philip wanted to observe how caterpillars grow. He placed two caterpillars with several leaves for the caterpillars to feed on in an uncovered container.

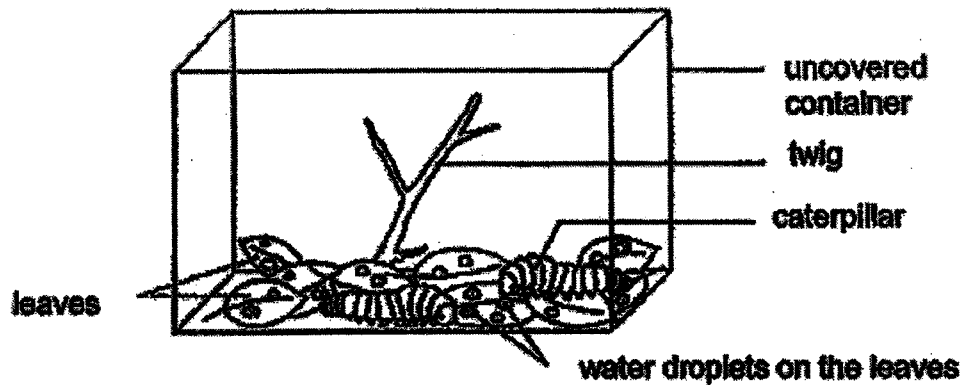

- (a) After a few days, will the amount of leaves in the container *increase, decrease or remain the same?* [1]

- (b) Based on the set-up above, state one thing that the caterpillars need to survive. [1]

- (c) To ensure the survival of the caterpillars, Philip should not seal the top of the container. Give a reason why. [1]



(Go on to the next page)

30 Study the flowchart below.

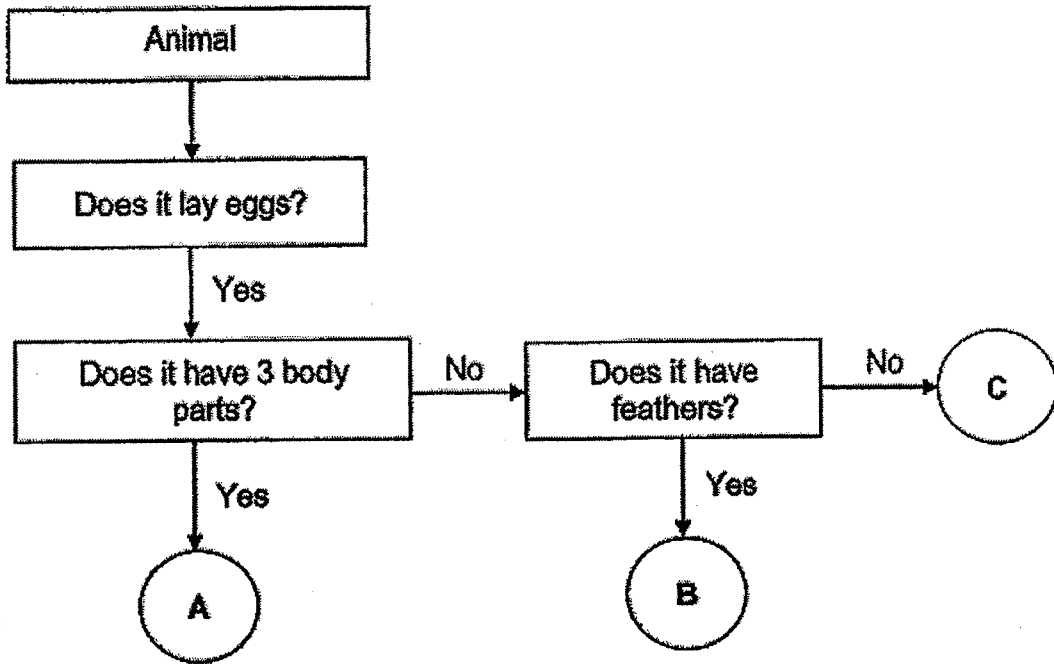

(a) Which animal group does A and B belong to? [2]

Animal A : _____

Animal B : _____

(b) State one similarity between animals B and C. [1]

(c) Siti concluded that animal C is not a cat. Based on the flowchart, explain how Siti came to this conclusion. [1]

31 The diagram below shows the stages in the life cycle of a cockroach.

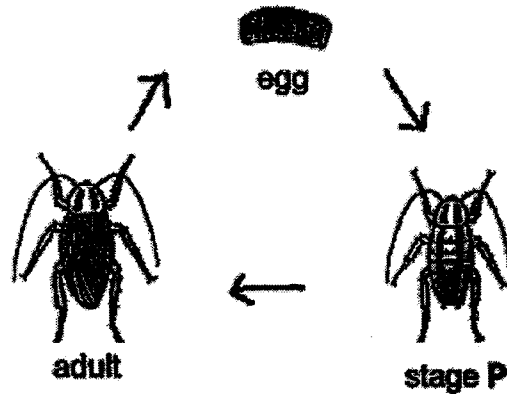

(a) Name stage P. [1]

(b) Which animal has the same number of stages as the life cycle of a cockroach? Tick (✓) the correct box(es). [1]

chicken

frog

grasshopper

(c) State one difference between the life cycle of a butterfly and the life cycle of a cockroach. [1]

(d) Why do living things undergo life cycles? [1]

	4
--	---

(Go on to the next page)

- 32 Maria placed two plants, A and B, in the soil as shown. The roots of plant A were cut off but not plant B. She watered both plants with the same amount of water daily for four weeks.

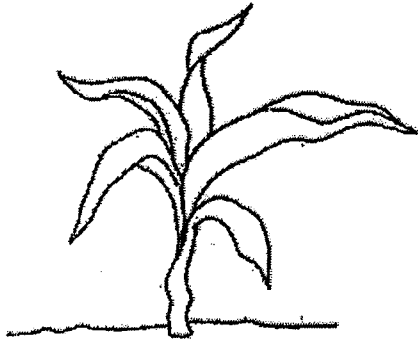

Plant A

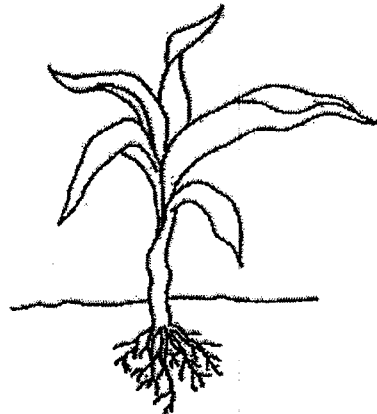

Plant B

- (a) Name the plant part which keeps the plant upright. [1]

- (b) Which plant, A or B, will grow healthier after four weeks? Explain your answer. [2]



(Go on to the next page)

33 The diagram below shows the human digestive system. A, B, C and D are different parts of the digestive system.

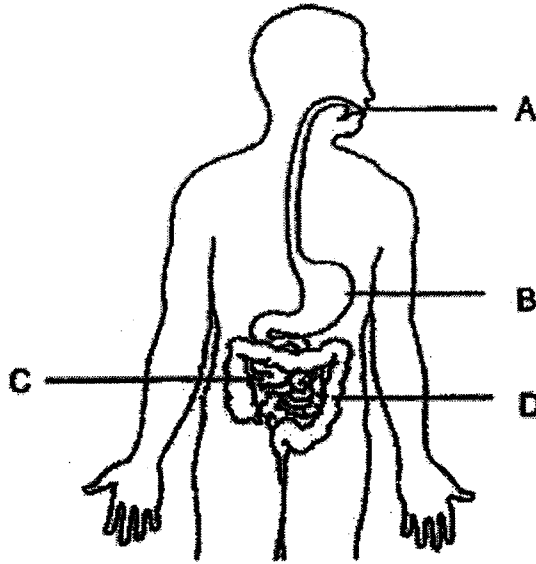

(a) Identify the part where [2]

(i) digestion is completed : _____

(ii) there is no digestion : _____

(b) Name the part inside A that chews food into smaller pieces. [1]

(c) State the function of part D of the digestive system. [1]

34 The table below shows the properties of materials P, Q and R.

Material	Allows most light to pass through	Breaks easily	Bends easily without breaking
P	Yes	No	No
Q	No	No	Yes
R	No	Yes	No

- (a) Based on the table above, what materials are Q and R likely to be? [2]
Fill in Q and R in the table below.

	Material
ceramic	
rubber	

The picture below shows a milk bottle. The markings outside the milk bottle allows the user to see the volume of the milk in the bottle.

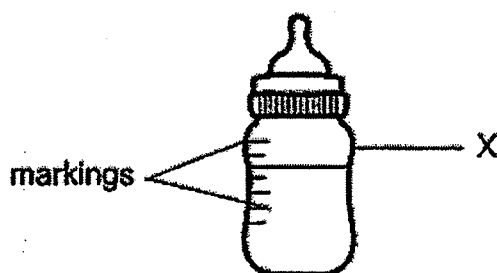

- (b) Which material, P, Q or R, is most suitable to make part X of a milk bottle? Explain your answer. [2]

	4
--	---

(Go on to the next page)

35 Study the flowchart below.

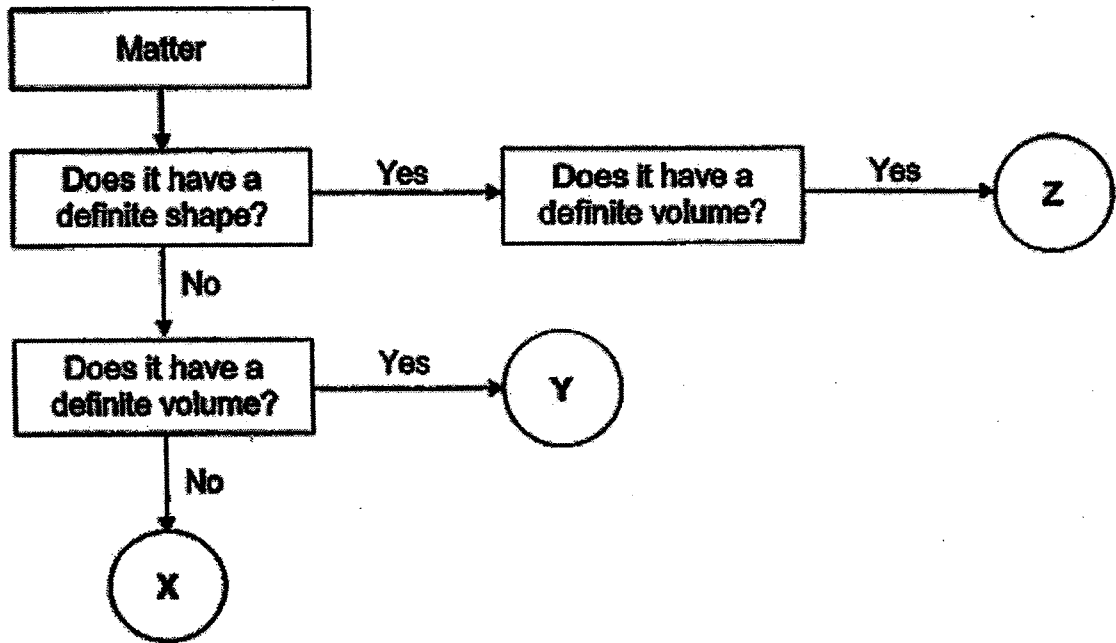

(a) Identify the state of matter for letters X and Z. [2]

X: _____

Z: _____

(b) State one difference between Y and Z. [1]

(c) Which matter, X, Y or Z, represents air? [1]



(Go on to the next page)

- 36 Jane wants to investigate how the number of strokes on an iron rod affects its magnetism. She stroked two similar iron rods, P and Q, with the same magnet as shown in the figure below.

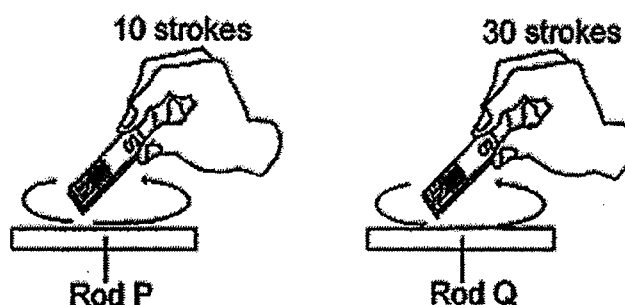

Both rods became magnets and were used to attract iron pins. She then held the rods above two trays of iron pins as shown.



- (a) Circle the correct answer below. [1]

Rod P attracted

(less pins than / the same number of pins as / more pins than) rod Q.

- (b) Explain your answer in (a). [1]

- (c) To ensure a fair test, which variables need to remain the same? [2]

Tick (✓) the correct boxes.

- number of strokes by the magnet
- direction of strokes by the magnet
- distance between the iron rod and pins
- number of pins attracted by the iron rods

	4
--	---

(Go on to the next page)

- 37 Mizah set up an experiment shown below. A shadow of the wooden block was cast on the screen when she turned on the lamp. The height of the shadow was recorded.

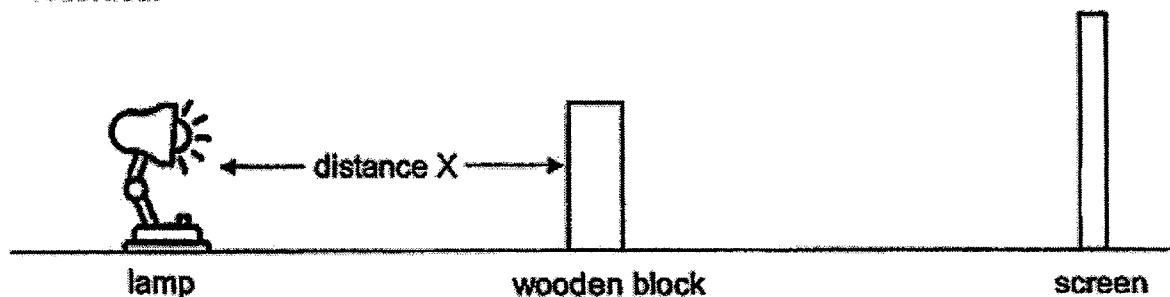

Mizah repeated the experiment with different distance X by shifting the position of the wooden block. The table below shows her results.

Distance X (cm)	5	10	15	20	25
Height of shadow (cm)	35	30	25	20	?

- (a) Based on the information given, what is the relationship between distance X and the height of the shadow? [1]

- (b) What is the height of the shadow when distance X is 25 cm? [1]

- (c) Mizah replaced the wooden block with a similar sized piece of frosted glass. Will a shadow be formed? Explain why. [1]



(Go on to the next page)

- 38 Marianne conducted an experiment using the set-up below. The flask was filled with air.

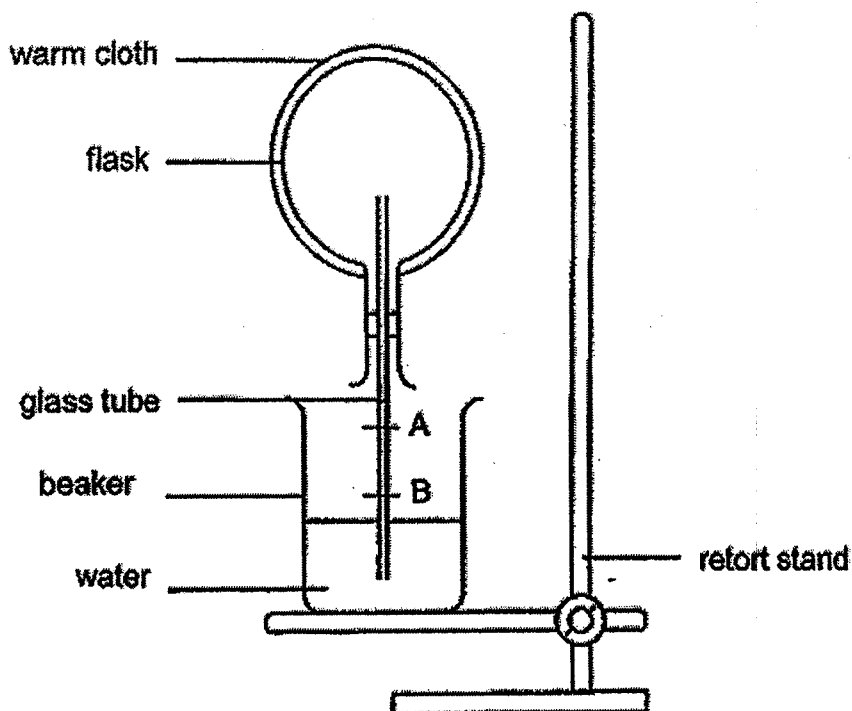

Marianne wrapped the flask with a warm cloth. She noticed that the water level in the glass tube moved from A to B.

- (a) Explain why the water level moved from A to B. [2]

- (b) After 2 hours, what will happen to the water level in the glass tube at B? Explain why. [2]

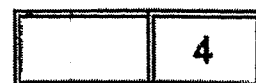

(Go on to the next page)

- 39 Frank filled a beaker with water as shown in the diagram.

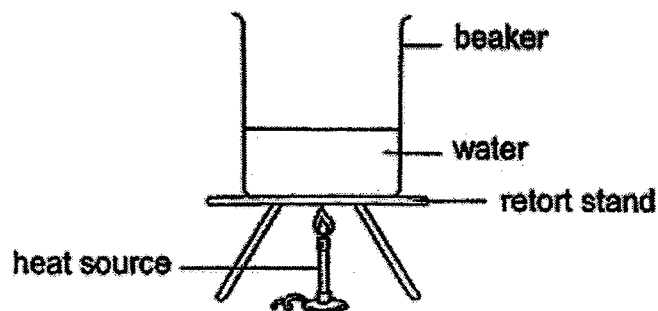

- (a) Fill in the blanks using the correct words in the box. [2]

gas	solid	decreases
increases	remains unchanged	

- (i) When heat is removed from the water, its temperature _____.
- (ii) The beaker of water is put in the freezer. After some time, the water will change its state to become _____.

	2
--	---

(Go on to the next page)

Then, Frank carried out an investigation with 2 containers of the same size but made of different materials, A and B. He filled each container with the same volume of hot water and left them on the table.

He measured the temperature of the water every minute and plotted the results in the graph below.

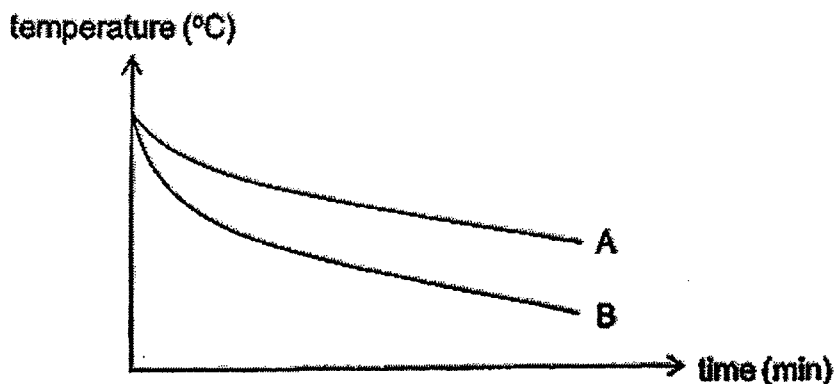

(b) Based on the information above, put a tick (✓) in the correct boxes. [2]

Statement	True	False	Not possible to tell
Material A is a poorer conductor of heat than material B.			
Cold water will stay cold longer when poured into a cup made of material B.			

	2
--	---

(Go on to the next page)

- 40 A metal ball was heated over a flame for 10 minutes and immediately placed into a container of water at room temperature.

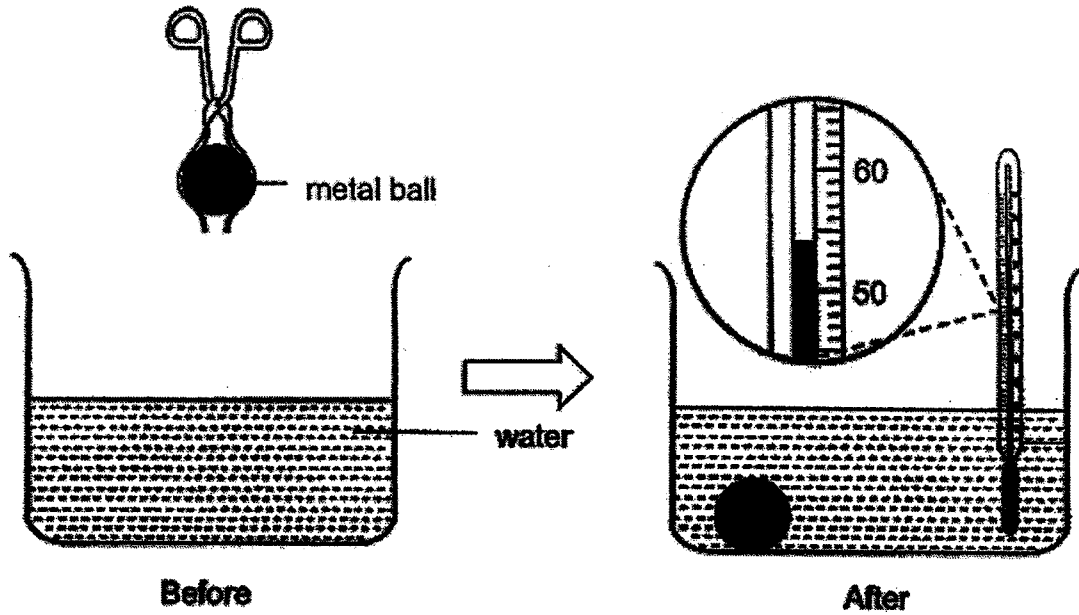

- (a) What is the temperature of the water shown on the thermometer? [1]

- (b) Give a reason why the temperature of the water changed when the ball was placed in. [1]

- (c) Based on the experiment, what can you conclude about heat transfer? [1]

SCHOOL : MARIS STELLA PRIMARY SCHOOL
LEVEL : PRIMARY 4
SUBJECT : SCIENCE
TERM : 2022 SA2

SECTION A

Q 1	Q2	Q3	Q4	Q5	Q6	Q7	Q8	Q9	Q10
3	2	3	2	3	4	3	2	1	4
Q11	Q12	Q13	Q14	Q15	Q16	Q17	Q18	Q19	Q20
2	3	3	4	2	1	3	1	3	3
Q 21	Q22	Q23	Q24	Q25	Q26	Q27	Q28		
1	1	1	4	4	2	1	2		

Section B

Q29)	<ul style="list-style-type: none"> a) It will decrease. b) Food c) Caterpillars need air to survive.
Q30)	<ul style="list-style-type: none"> a) Animal A : Insects Animal B : Birds b) Both lay eggs c) A cat is a mammal and does not lay eggs.
Q31)	<ul style="list-style-type: none"> a) Nymph b) Chicken and grasshopper c) Butterfly has four-stage life cycle while a cockroach has three-stage life cycle. d) This is to allow continuity of its kind.
Q32)	<ul style="list-style-type: none"> a) Stem b) B. It has roots to absorb water. Plant A does not have roots. So it cannot grow healthier.
Q33)	<ul style="list-style-type: none"> a) i) C ii) D b) Teeth c) Take in water from the undigested food

Q34)	<p>a) Ceramic → R Rubber → Q</p> <p>b) P. As it is the only one that allows light to pass through and the user can see the bottle easily and does not break easily.</p>
Q35)	<p>a) X : Gas Z : Solid</p> <p>b) Y does not have a definite shape but Z has a definite shape.</p> <p>c) X</p>
Q36)	<p>a) Less pins than</p> <p>b) The more number of strokes on the magnet, the stronger the magnetism it has.</p> <p>c) Direction of strokes by the magnet Distance between the iron rod and pins</p>
Q37)	<p>a) The longer the distance X increases, the height of the shadow decreases.</p> <p>b) 15 cm</p> <p>c) Yes. The frosted glass can block some light)</p>
Q38)	<p>a) The air expanded and air occupies space pushing the water.</p> <p>b) The water level will go up. Air in the flask lost heat to the surrounding and contracted.</p>
Q39)	<p>a) i) decreases ii) solid</p> <p>b) True False</p>
Q40)	<p>a) 54°C</p> <p>b) The metal ball lost heat to the water.</p> <p>c) A hotter object will lose heat to a colder object.</p>