

HENRY PARK PRIMARY SCHOOL
END OF THE YEAR EXAMINATION 2022
PRIMARY 4
SCIENCE
SECTION A (56 MARKS)

INSTRUCTIONS TO CANDIDATES

1. Do not turn over this page until you are told to do so.
2. Follow all instructions carefully.
3. Answer all questions.
4. Shade your answers on the Optical Answer Sheet (OAS) provided.

Name: _____ ()

Class: Primary 4 ()

Date: 28 October 2022

Total Time for Booklets A and B: 1 h 45 min

Sections	Marks
A	/ 56
B	/ 44
Total	/ 100

Parent's Signature: _____

Booklet A (50 marks)

For each question from 1 to 28, four options are given. One of them is the correct answer. Make your choice (1, 2, 3 or 4). Shade the correct oval (1, 2, 3 or 4) on the Optical Answer Sheet.

- 1 Which one of the following is a living thing?



(1)



(2)

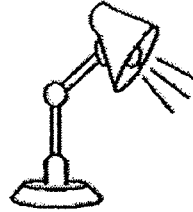

(3)



(4)

- 2 Which organ system is shown in the diagram?

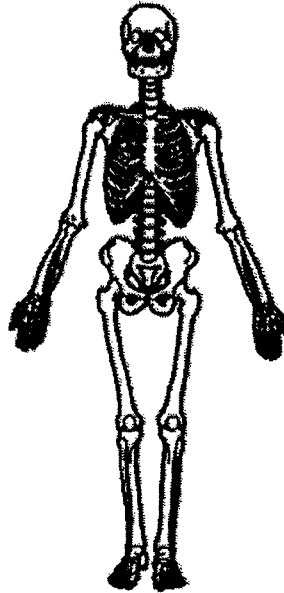

- (1) skeletal system
- (2) muscular system
- (3) digestive system
- (4) respiratory system

3 In which part of the digestive system is digested food absorbed into the blood?

- (1) gullet
- (2) stomach
- (3) large intestine
- (4) small intestine

4 Tom made the following observations on the life cycle of an animal.

- There are three stages in the life cycle.
- The young looks like the adult.

Which animal was Tom observing?

- (1) frog
- (2) chicken
- (3) butterfly
- (4) beetle

5 The arrows (→) in the diagram below show the direction of movement of a substance in plants.

roots → stem → leaves

What is this substance?

- (1) soil
- (2) food
- (3) water
- (4) sunlight

6 Which one of the following is the best conductor of heat?

- (1) A glass rod
- (2) A metal rod
- (3) A plastic rod
- (4) A wooden rod

- 7 Ronald places a metal spoon in a cup of iced tea.

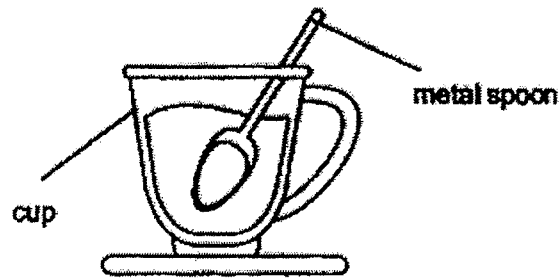

a cup of iced tea

The spoon becomes colder after a while.

Which one of the following explains this?

- (1) The cup loses heat to the iced tea.
- (2) The iced tea gains heat from the cup.
- (3) The spoon loses heat to the iced tea.
- (4) The spoon gains heat from the iced tea.

- 8 Which one of the following is a source of light?



eyes

(1)



mirror

(2)



fire

(3)



moon

(4)

- 9 An object is placed in front of a light source. A shadow is formed on the screen as shown below.

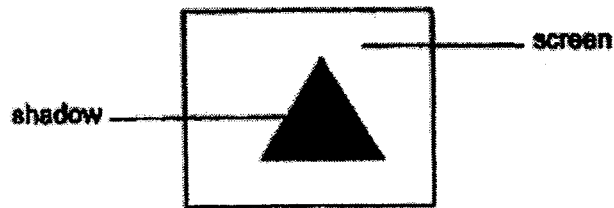

Which one of the following shows the object that could have been used to form the shadow?

(1)



(2)



(3)

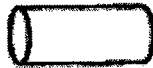

(4)



- 10 The diagram shows a rod magnet brought near a plastic cube.



Rod magnet



Plastic cube

What will happen to the plastic cube?

- (1) It will move up.
- (2) It will not move.
- (3) It will move to the left.
- (4) It will move to the right.

11 The diagram shows a plant with two leaves, S and T.

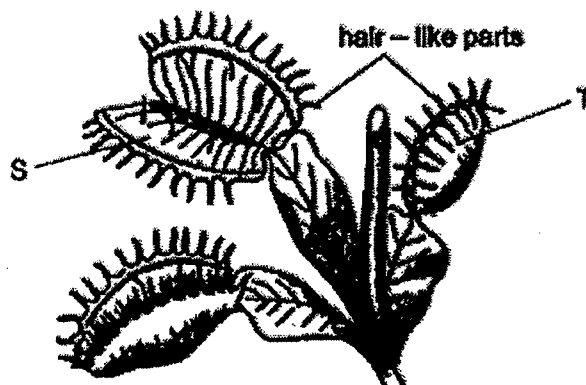

After an insect landed on leaf S, it closed and became like leaf T.

Which characteristic of living things does this show?

- (1) Living things grow.
- (2) Living things reproduce.
- (3) Living things respond to changes.
- (4) Living things need air, food and water.

12 Study the flowchart below.

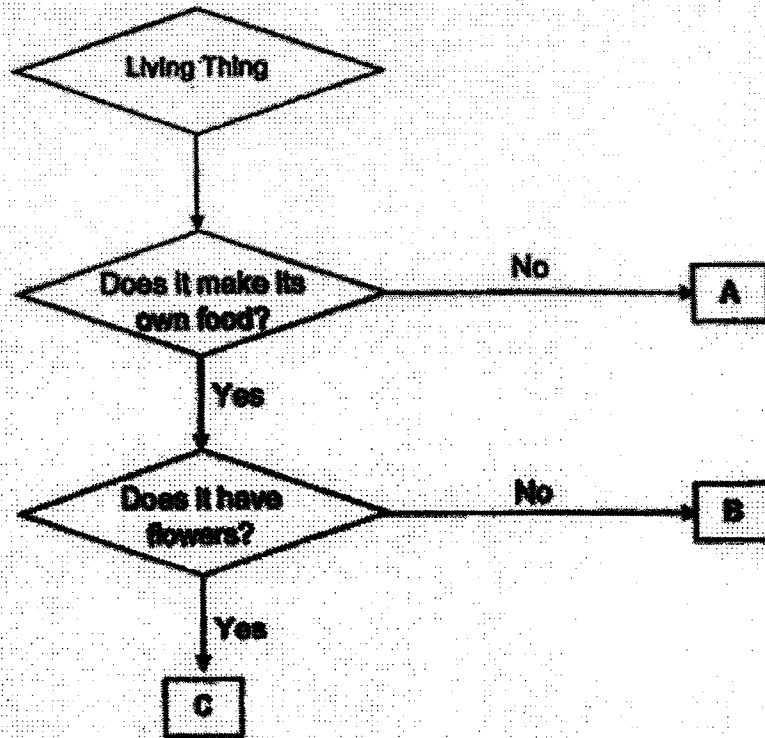

Which of the following correctly identifies A, B and C?

	A	B	C
(1)	fern	mushroom	rose
(2)	fern	rose	mushroom
(3)	mushroom	fern	rose
(4)	mushroom	rose	fern

- 13 The diagram shows a pond in Mary's school.

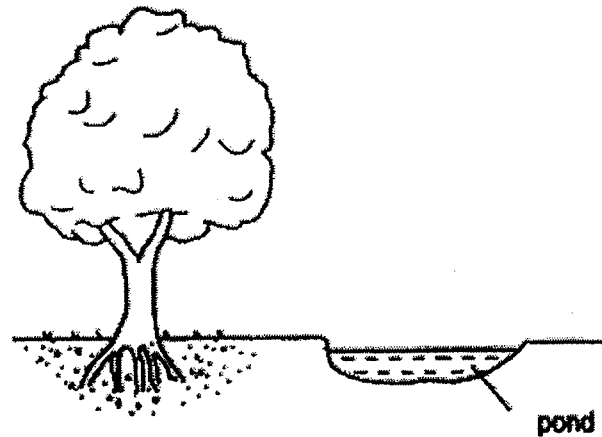

Mary observed 3 types of animals, X, Y and Z, living near the pond.

Only animals Y and Z lay their eggs in the pond. The young of animals Y and Z live in water.

The table shows the number of days needed for their eggs to hatch.

Animal	Observation
	Number of days needed for eggs to hatch
X	3
Y	1
Z	21

On day 15, what would Mary most likely find in the pond?

- (1) young of animals X and Y
- (2) young of animals of Y and Z
- (3) young of animal Y and eggs of animal Z
- (4) young of animal X and eggs of animal Z

14 The diagram shows the life cycle of a mosquito.

Jim sprayed oil onto the possible breeding grounds of mosquitoes in order to prevent mosquitoes from breeding.

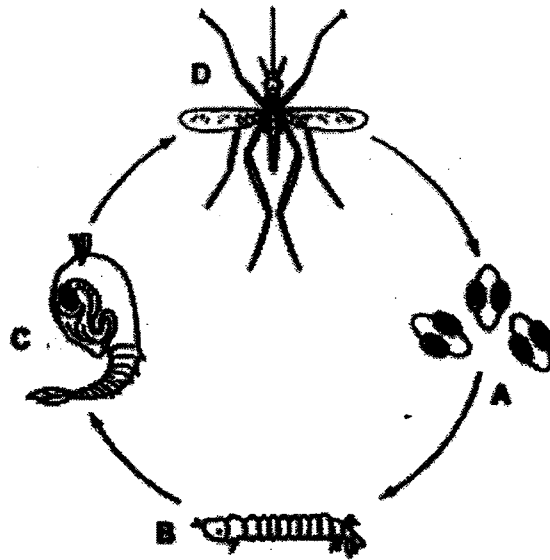

In which of the following stages does this method help to reduce the number of mosquitoes?

- (1) A and D
- (2) B and D
- (3) B and C
- (4) C and D

15 The diagram below shows a plant at different stages.

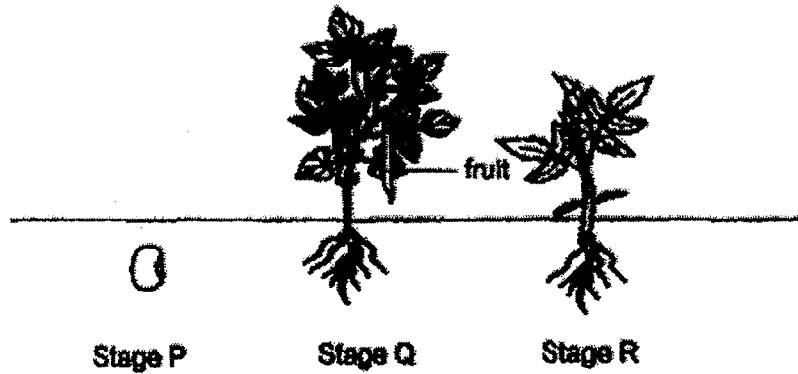

Which of the following statement(s) below is/ are correct?

- A The plant reproduces by seeds.
- B The plant needs sunlight in all three stages.
- C The plant can make its own food at Stage R.

- (1) A and B only
- (2) B and C only
- (3) A and C only
- (4) A, B and C

- 16 The diagram below shows a plant with four parts, A, B, C and D.

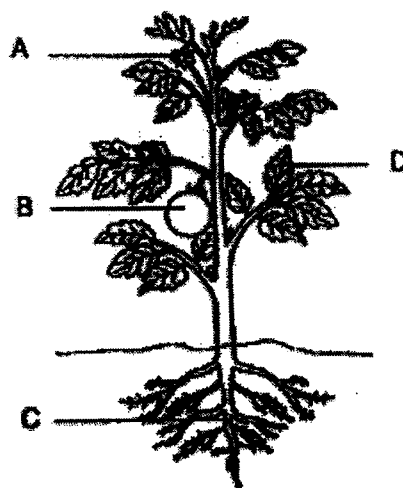

Which statement correctly describes what happens when one part is damaged?

- (1) When part C is damaged, the plant will wither.
- (2) When part B is damaged, the plant cannot make food.
- (3) When part A is damaged, the plant cannot stay upright.
- (4) When part D is damaged, the plant cannot take in water.

- 17 The diagram below shows the human digestive system.

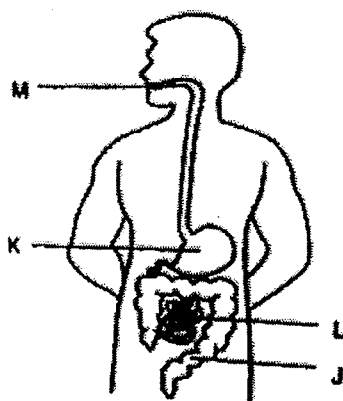

Which of the following correctly identifies where digestion occurs and where water is removed?

	where digestion occurs	where water is removed
(1)	K and M	M
(2)	K and L	K
(3)	K, L and M	L
(4)	K, L and M	J

- 18 After Mr Pang removed a section of his small intestine, he lost a lot of weight and had to eat more frequently.

Based on the information given above, which of the following are possible effects after the removal of a section of the small intestine?

- A The absorption of food will be less.
- B The absorption of food will be more.
- C The digestion of food will be faster.
- D The digestion of food will be slower.

- (1) A and C
- (2) A and D
- (3) B and C
- (4) B and D

10 Study the flowchart below.

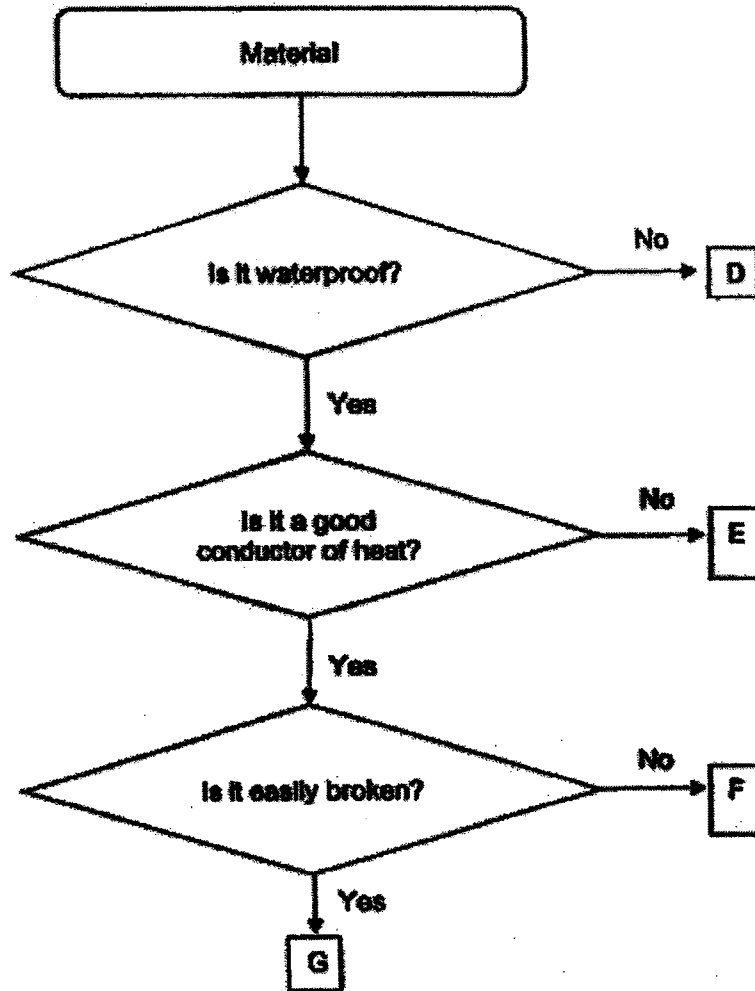

Which material should Siti use to make parts X and Y of a frying pan?



	Part X	Part Y
(1)	D	E
(2)	E	F
(3)	F	E
(4)	F	G

- 20 Alicia wanted to test the strength of bags made of four different materials, P, Q, R and S.

She placed 50-gram weights, one at a time, into each bag until it tore.

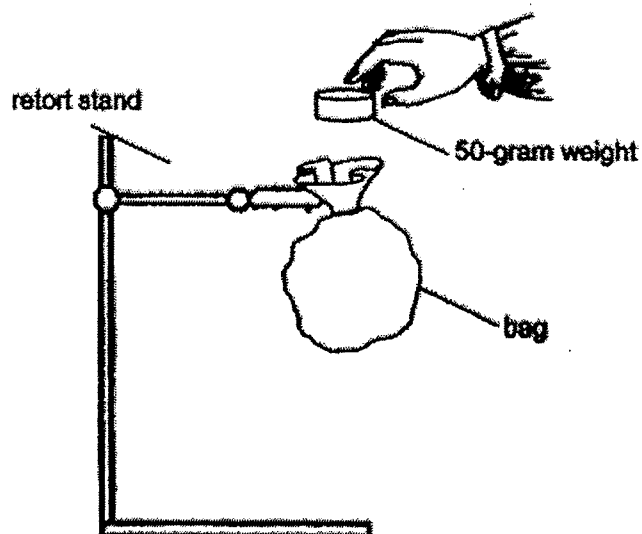

The table below shows the number of weights the bags could hold before they tore.

Material of bag	P	Q	R	S
Number of 50-gram weights	10	5	3	8

Based on the results, which material, P, Q, R or S is most suitable for making a pouch to hold a very large number of coins?

- (1) P
- (2) Q
- (3) R
- (4) S

- 21 The diagrams show three set-ups with magnets W, X, Y and Z.
The magnets have the same mass.

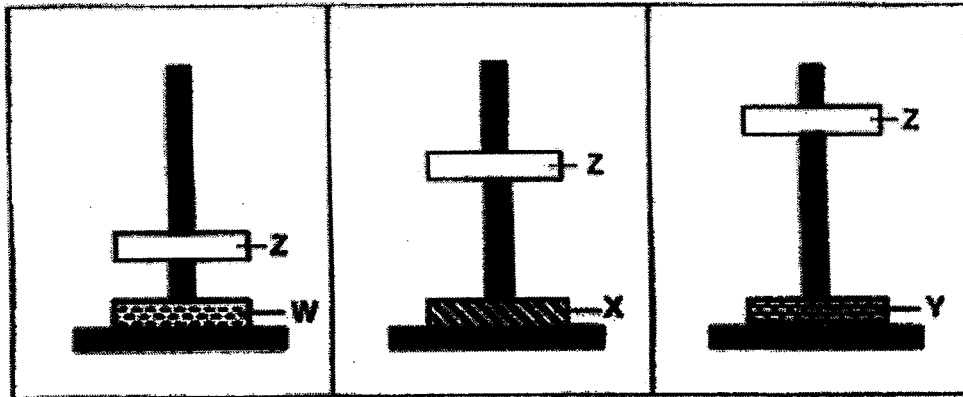

Which one of the following statement(s) is/are correct?

- A Magnet W is stronger than X and Y.
 B Magnet Y is stronger than W and X.
 C Magnet X is weaker than W but stronger than Y.
- (1) A only
 (2) B only
 (3) B and C only
 (4) A, B and C

- 22 Emma placed three iron bars on a wooden table as shown below. Two of the iron bars are magnets.

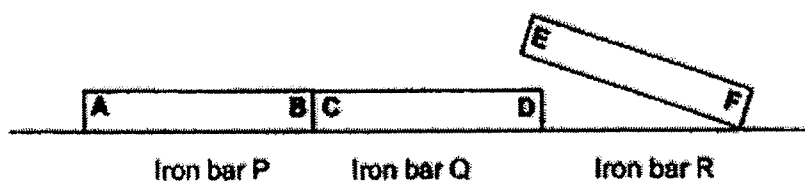

End F of iron bar R was brought close to each end of the other two iron bars.
Based on the information given, which of the following observations is possible?

Observations when end F was brought near				
	End A	End B	End C	End D
(1)	attract	repel	attract	repel
(2)	attract	attract	repel	attract
(3)	repel	repel	repel	attract
(4)	repel	attract	attract	repel

- 23 One night, Jason walked from point A to point C, passing a lamppost at point B as shown in the diagram below.

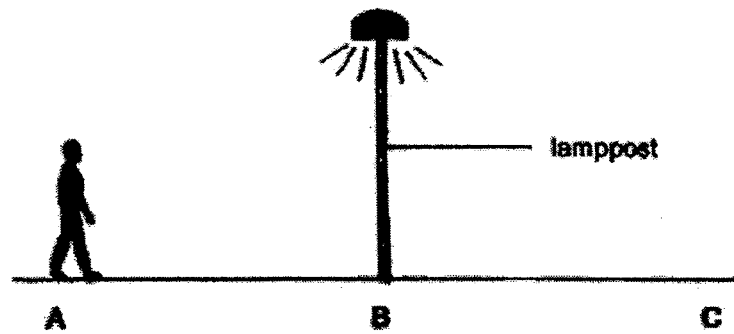

The lamppost is the only light source nearby. Which of the graphs below shows how the length of his shadow changes from points A to C?

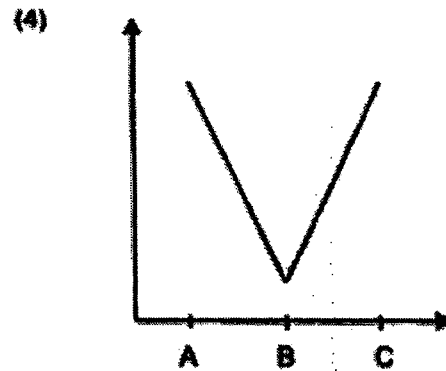
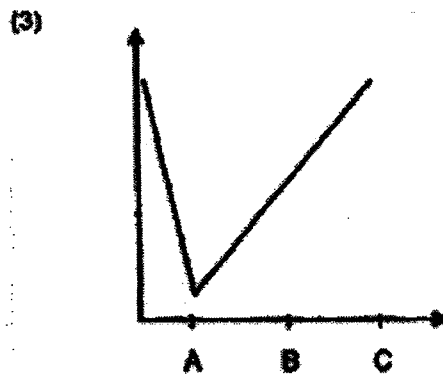
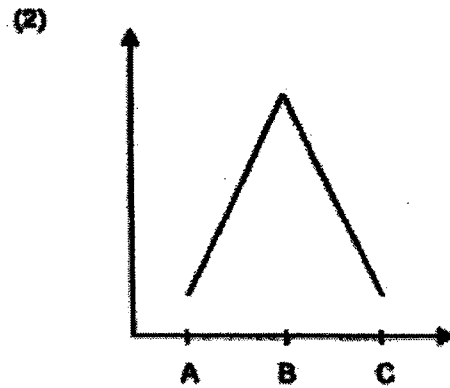
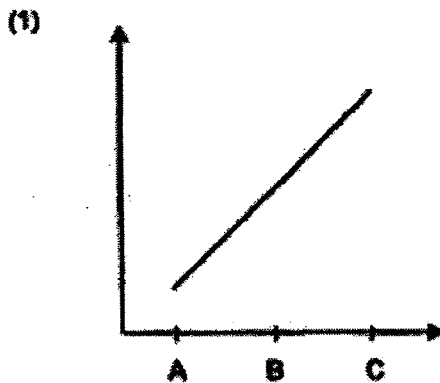

- 24 The diagram shows a light source and a light sensor placed on a piece of wooden board.

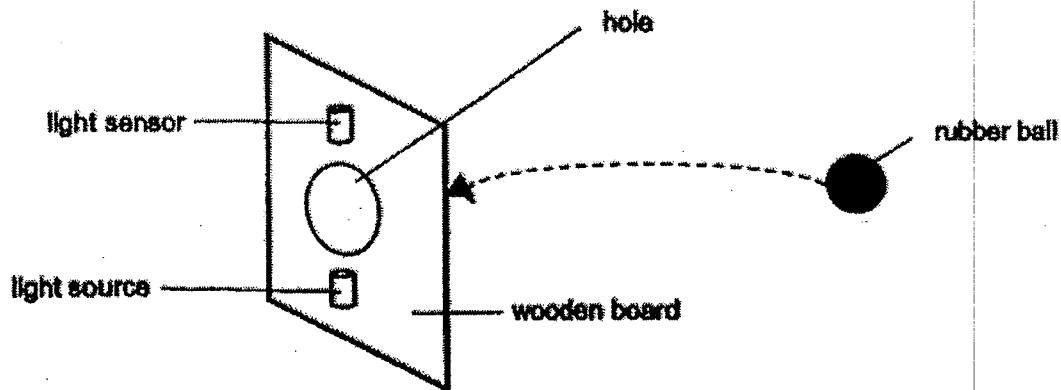

Ken used the set-up to count the number of rubber balls that were thrown, one at a time, through the hole. The results were recorded and shown in the graph below.

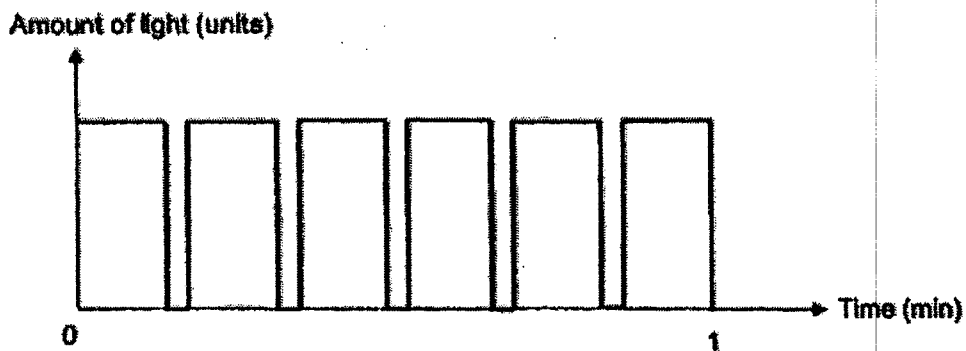

Based on the graph, how many rubber balls were thrown through the hole within 1 minute?

- (1) 5
- (2) 6
- (3) 11
- (4) 12

25 The table below shows the characteristics of objects P and Q.

A tick (✓) represents the presence of the characteristic.

Characteristic	Object	
	P	Q
Occupies space	✓	✓
Can be compressed		✓
Takes the shape of its container	✓	✓

Objects P and Q can be represented by A, B or C in the flowchart below.

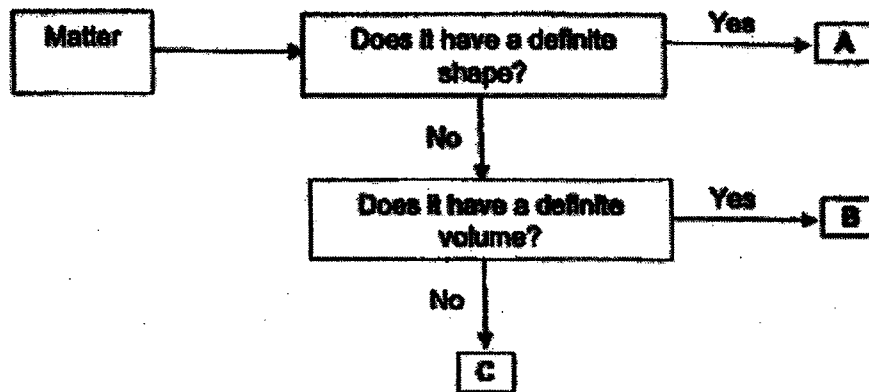

Based on the flowchart above, which letters A, B or C represent objects P and Q?

	Object P	Object Q
(1)	A	B
(2)	A	C
(3)	B	C
(4)	C	B

- 26 Bala received three parcels, A, B and C, that contained glass marbles, wooden blocks and plastic cubes respectively. He was also given a beam balance to measure the mass of the parcels.

Parcel size	A	B	C
Parcel Contents	glass marbles	wooden blocks	plastic cubes
Total parcel mass	350g	600g	350g

Which of the following diagrams is correct?

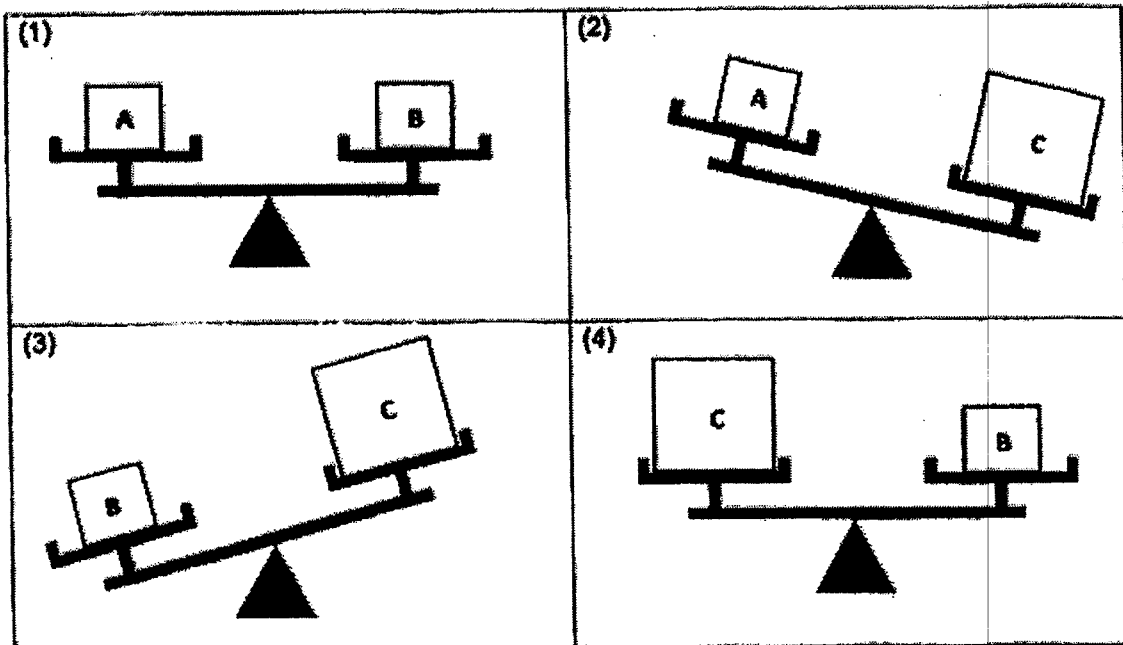

27 Study the diagram below.

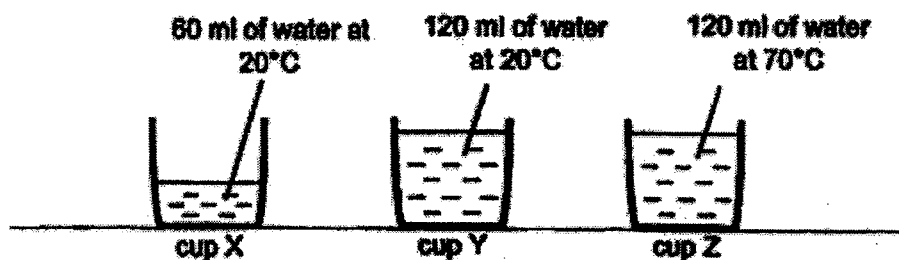

Three students made the following statements.



Ali

The water in cup X contains less heat than the water in cup Y.



Ben

The water in cups Y and Z contain the same amount of heat.



Calli

The water in cup Z contains the most amount of heat.

Which of the student(s) is/are correct?

- (1) Ben only
- (2) Calli only
- (3) All and Ben only
- (4) All and Calli only

28 The diagram shows container A placed in a basin of water.

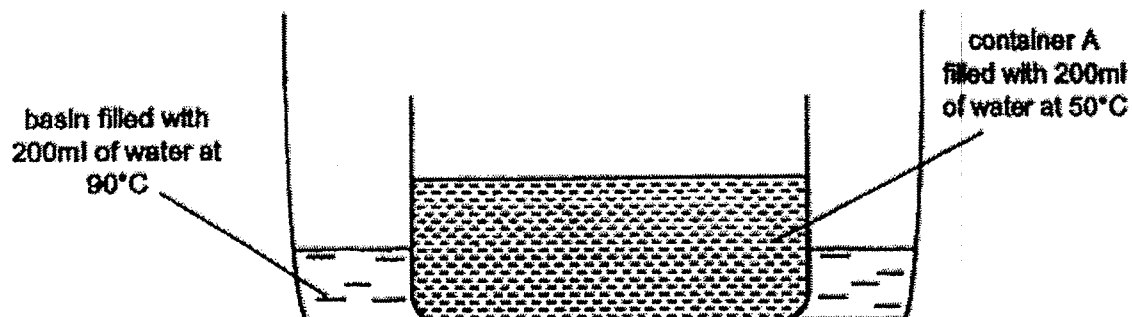

The whole set-up was placed in a room. The temperature of the room is 23°C. After five hours, what could the temperature of the water in container A and the basin be?

Temperature of water in		
	Container A	Basin
(1)	90°C	50°C
(2)	50°C	50°C
(3)	23°C	23°C
(4)	50°C	23°C

End of Booklet A

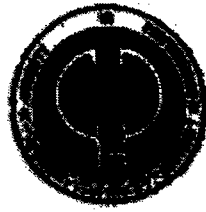

**HENRY PARK PRIMARY SCHOOL
END OF THE YEAR EXAMINATION 2022**

PRIMARY 4

SCIENCE

SECTION B (44 MARKS)

INSTRUCTIONS TO CANDIDATES

1. Do not turn over this page until you are told to do so.
2. Follow all instructions carefully.
3. Answer all questions.

Name: _____ ()

Class: Primary 4 ()

Date: 28 October 2022

Total Time for Booklets A and B: 1 h 45 min

Marks for Section B: _____

Booklet B (44 marks)

For questions 28 to 41, write your answers in the space provided.

29 Draw lines to match the following animals to the correct groups. [3]

Animal

Animal Group



● reptile

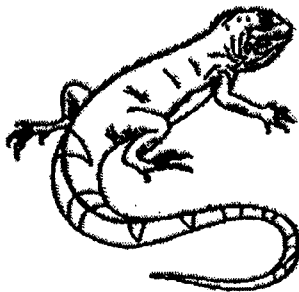

● bird



● insect

● mammal

- 30 The diagram shows a raincoat. It has water droplets on it.

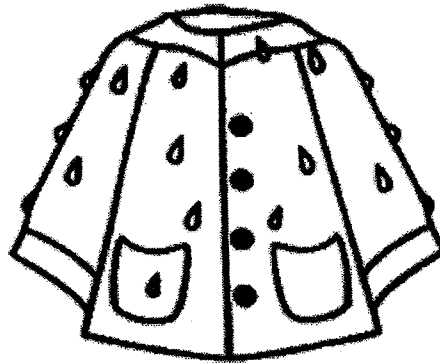

Fill in the blanks using the correct words in the box.

water	heat	waterproof	magnetic
-------	------	------------	----------

- (a) The raincoat does not absorb _____ [1]
- (b) The raincoat is made of a _____ material. [1]

- 31 Alice placed two ring magnets, A and B, through a holder as shown below.

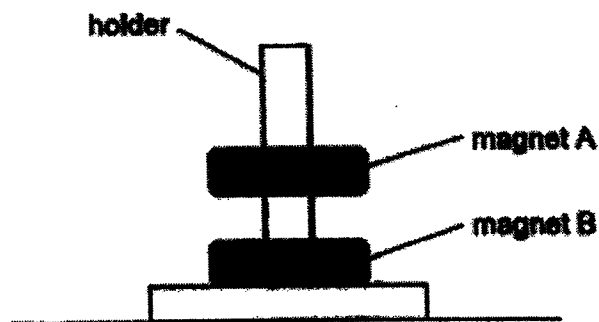

- (a) The holder was made of rubber and did not attract the magnets.
Rubber is a _____ material. [1]
- (b) Why was magnet A floating above magnet B?
Magnet B was _____ magnet A. [1]

32 The diagram below shows the young and adult of some animals.

Draw lines to match the young with the correct adult.

[3]

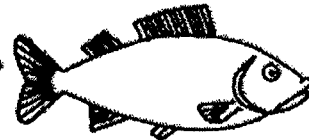

33 Study the classification chart below.

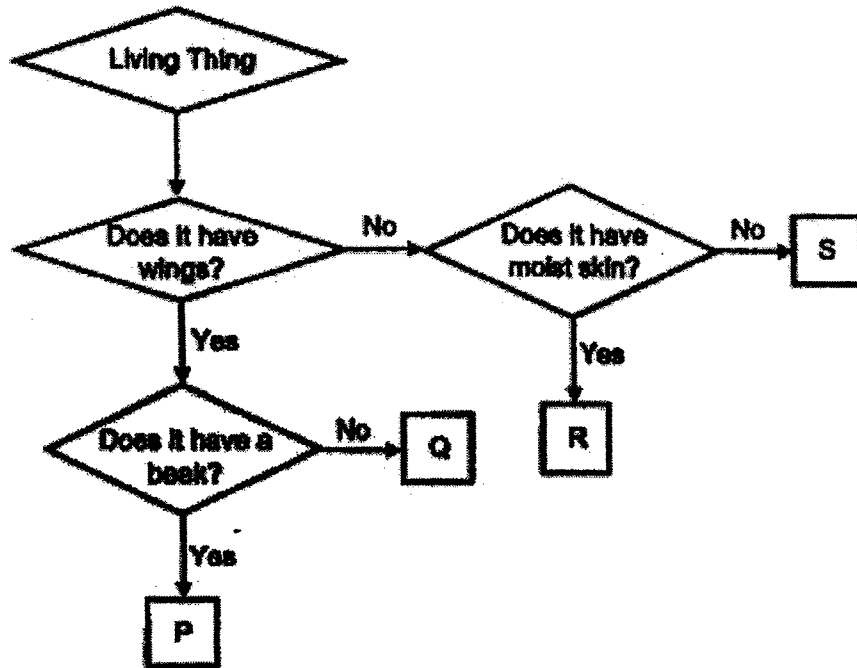

David saw some animals in the garden and drew them below.



(a) Match each animal to the letter that represents it. Write the letters, P, Q, R and S, in the boxes provided. [2]

Question 33 continued

David also observed T growing on a log.



- (b) Name another living thing that belongs to the same group as T. [1]

- (c) Give a reason why T grows on the log. [1]

34 The diagrams show the life cycle of animals P and Q.

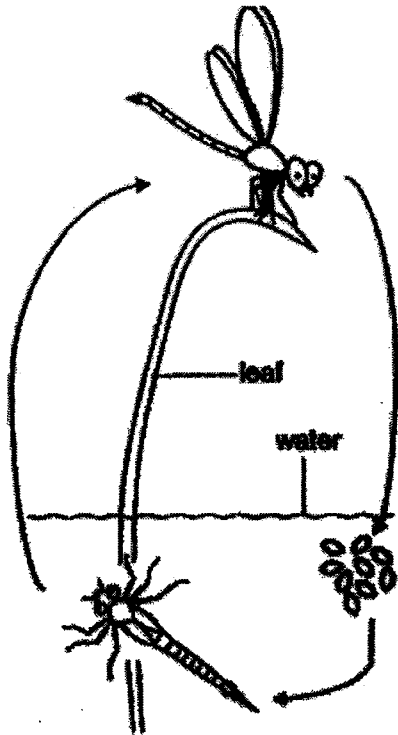

Life Cycle of Animal P



Life Cycle of Animal Q

(a) State a similarity between the life cycle of animal P and animal Q. [1]

(b) Eggs of animal P are found in pondwater while the eggs of animal Q are found in the ground. State another difference between the life cycle of animal P and animal Q. [1]

(c) Which group of animals does animals P and Q belong to? Give a reason for your answer. [1]

Question 34 continued

- d) Both the adults of animals P and Q lay many eggs at one time. [1]
 Explain how this helps to ensure the survival of the animals.

35 The classification chart below shows three human systems and some of their parts.

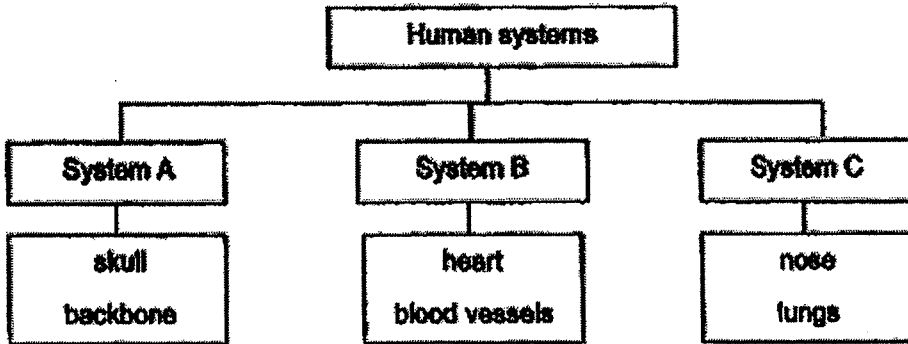

- a) Name systems A and B. [1]
 System A : _____ System B : _____

- b) Name another part of system C. [1]

- c) State the function of system C. [1]

- 36 Jane conducted an experiment to find out how the number of coils of wire around the iron rod affects the strength of an electromagnet.

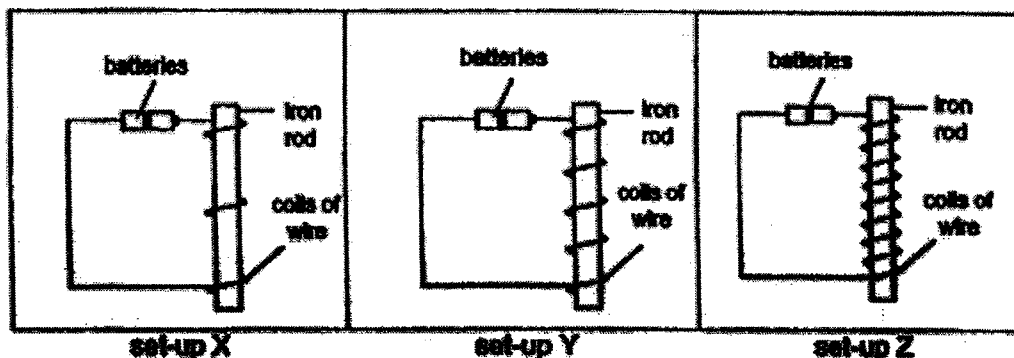

She brought the electromagnets in set-ups X, Y and Z near a box of steel clips. She recorded the number of steel clips attracted by each electromagnet as shown below.

Set-up	Number of steel clips attracted
X	20
Y	40
Z	70

- (a) What is the relationship between the number of coils of wire around the iron rod and the strength of the electromagnet? [1]

- (b) Predict how many steel clips would be attracted by the iron rod in set-up X when both batteries are removed. Explain your answer. [1]

Question 36 continued

The barrier at a carpark can be raised or lowered using an electromagnet. The diagram below shows the set-up of the barrier.

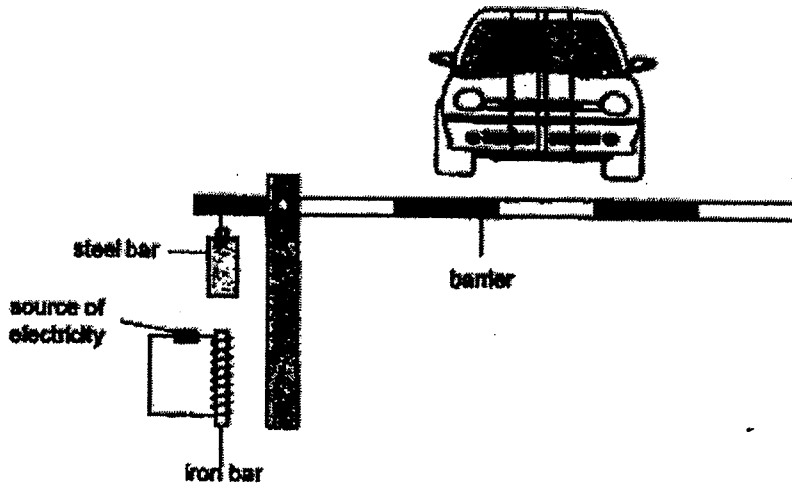

- (c) Describe what will be observed when the source of electricity is turned on. Explain your answer. [2]

- 37 The diagram shows a glass jar that contains marbles. The volume of the marbles is 300 cm^3 .

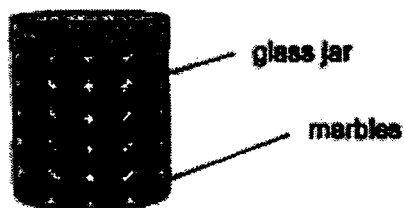

- (a) Danny says that the volume of the glass jar is more than 300 cm^3 . Do you agree with Danny? Explain your answer. [2]

- (b) The diagram below shows the set-up used to find the volume of a stone. Danny puts the whole stone into the water in the displacement can.

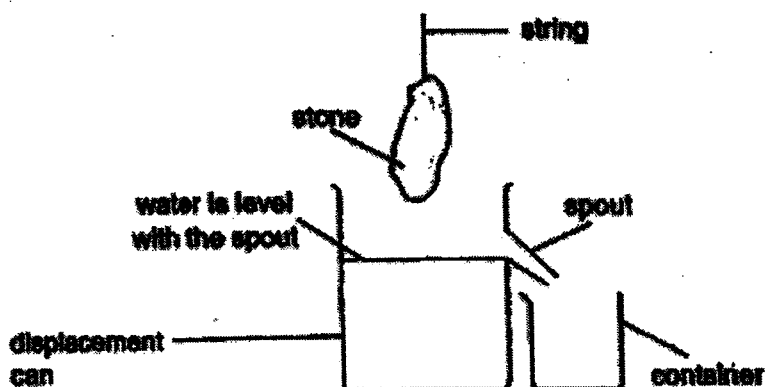

- (i) Describe what Danny would observe when he puts the whole stone into the water. Explain your answer. [1]

Question 37 continued

- (ii) The diagram below shows a measuring cylinder.

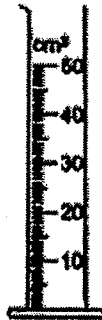

Using the measuring cylinder, describe what Danny should do next to find out the volume of the stone. [1]

- 38 James conducted an experiment with three rods, R, S and T, placed in a water tank as shown below. Rods R, S and T are made of different materials and are of the same length and thickness.

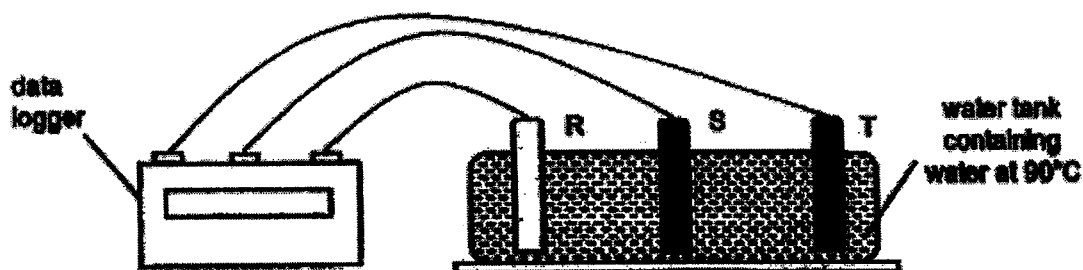

Each rod had a temperature of 25 °C at the start of the experiment. The rods were connected to a data logger and the changes in their temperature were measured and recorded in the table below.

Time (min)	Temperature (°C)		
	Material R	Material S	Material T
0	25	25	25
5	33	39	28
10	40	55	32
15	51	80	37

- (a) State what temperature is. (1)
-
-
- (b) What can James do to ensure that the results of the experiment are more reliable? (1)
-

Question 38 continued

The diagram below shows a cooking pot.

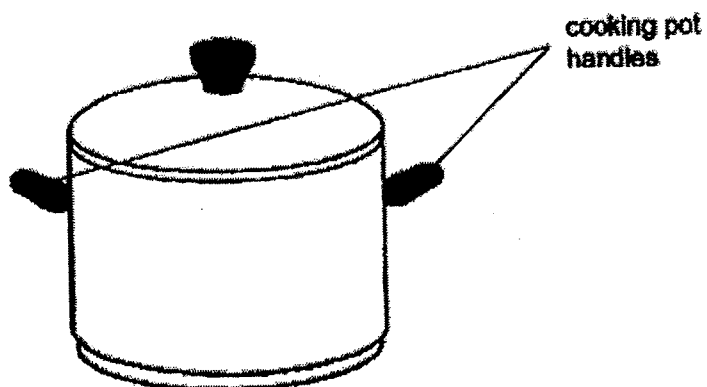

- (c) Based on the results of the experiment, which material R, S or T, is most suitable to make the handles of the cooking pot? Explain your answer. [2]

- 39 Jenny wanted to find out how absorbent different materials, X, Y and Z are. She set up the experiment as shown below and poured 100 cm^3 of water into the funnel lined with material X. She then measured the volume of water collected in the beaker.

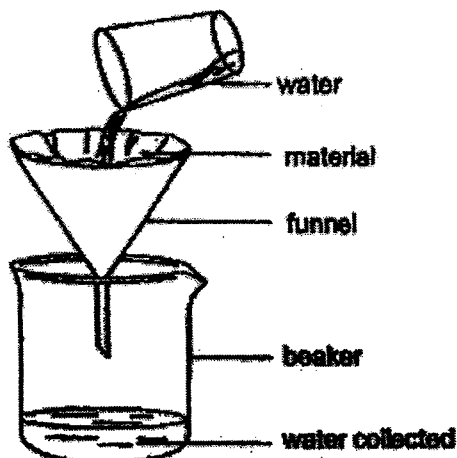

Jenny repeated the experiment using materials Y and Z. The table below shows the volume of water collected in the beaker when the funnel was lined with materials X, Y and Z.

Material	Volume of water / cm^3
X	15
Y	94
Z	83

- (a) Based on the results, which material is most suitable for cleaning up a water spill on the floor? Explain your answer. [2]

- (b) Jenny used materials of the same thickness during the experiment. Explain how using the same thickness helps to make the experiment a fair test. [1]

40 The diagram shows the layout of a stage for a shadow puppet show.

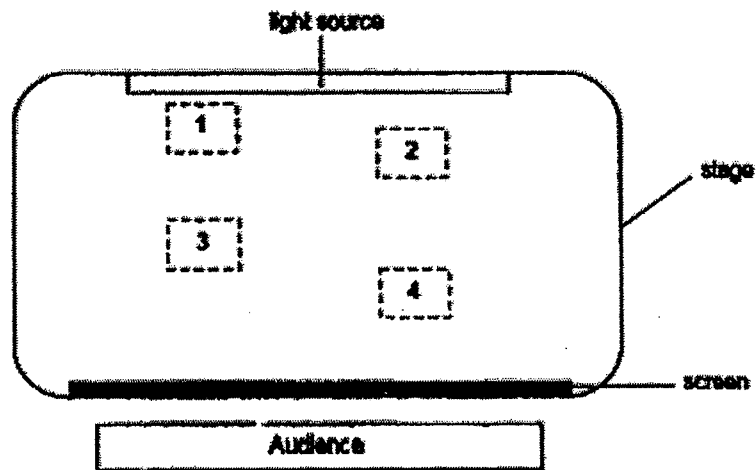

During the show, two wooden puppets, A and B of the same size and shape were used. The audience watching the show saw the shadows of the puppets on the screen as shown below.



(a) In order to form the above shadows, at which positions 1, 2, 3 or 4 were puppets A and B placed?
 Position of puppet A: _____ Position of puppet B: _____ [1]

(b) Explain your answer in (a). [2]

(c) Jeff stated that the material of the screen does not allow any light to pass through. Do you agree with Jeff? Explain your answer. [1]

- 41 The diagram shows a pump which is connected to a glass jar. The volume of the glass jar is 300 cm^3 and it contains 30 cm^3 of water.

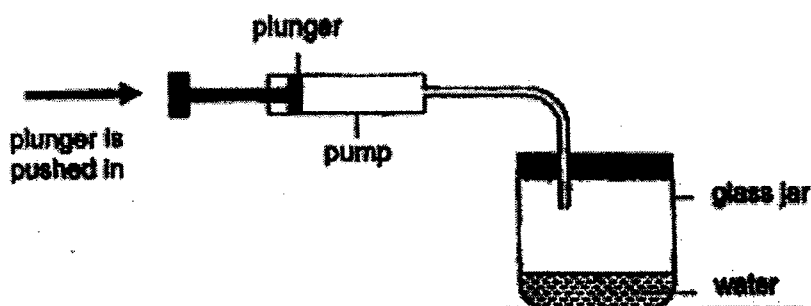

Each time the plunger of the pump is pushed in completely, 20 cm^3 of air is pumped into the glass jar.

- (a) State the volume of air and water in the glass jar after 20 cm^3 of air is pumped into the glass jar. [1]

Volume of air - _____ cm^3

Volume of water - _____ cm^3

- (b) Explain your answer in (a). [2]

- (c) Does the mass of the air in the glass jar increase, decrease or remains the same after 20 cm^3 of air is pumped into the glass jar? [1]

End of Booklet B

YEAR : 2022
 LEVEL : PRIMARY 4
 SCHOOL : HENRY PARK PRIMARY SCHOOL
 SUBJECT : SCIENCE
 TERM : END OF YEAR EXAMINATION

(BOOKLET A)

Q1	1	Q2	1	Q3	4	Q4	2	Q5	3
Q6	2	Q7	3	Q8	3	Q9	1	Q10	2
Q11	3	Q12	3	Q13	3	Q14	3	Q15	3
Q16	1	Q17	4	Q18	2	Q19	3	Q20	1
Q21	2	Q22	2	Q23	4	Q24	1	Q25	3
Q26	3	Q27	4	Q28	3				

(BOOKLET B)

Q29		
Q30	a)	The raincoat does not absorb water.
	b)	The raincoat is made of a waterproof material.
Q31	a)	Rubber is a non-magnetic
	b)	Magnet B was repelling material.
Q32		

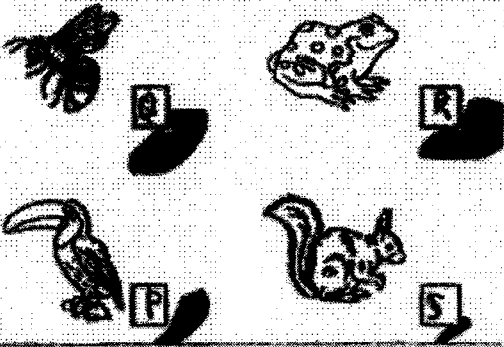
Q33	a)	
	b)	Fungi
	c)	There is moisture on the log causing the fungi to grow on it as it only requires water and warmth
Q34	a)	They have three stage life cycle.
	b)	Animal Q look nymph looks like the adult while Animal P does not.
	c)	Insect. They have 6 legs
	d)	So that some of the eggs would hatch.
Q35	a)	System A : Skeletal System B : Circulatory
	b)	Windpipe
	c)	Helps you inhale oxygen and exhale carbon dioxide.
Q36	a)	As the number of coils of wire increases, the strength of electromagnet increases.
	b)	Q. As there are no current flowing through causing the affect to attract any steel clips.
	c)	The barrier would go up as the electromagnet magnet is on causing the steel bar to be attracted.
Q37	a)	Air is occupying the sapce between the marbles.
	b)i)	The water level will rise and the water will flow out from the spout into the container. Therefore, the water in the container will be equivalent to the volume of the rock.
Q38	a)	Temperature is a measurement of how hot or cold an object is.
	b)	Repeat the experiment two more times
	c)	T. It has the lowest temperature after 15 minutes. Because the poorest of heat conducts heat slowest from pot to hands prevents hands from being burned.
Q39	a)	X absorbed the most amount of water. It is the most absorbent so it can absorb the most amount of water.
	b)	To ensure that the thickness of material is. The only thing causing the difference is results.
Q40	a)	Position of puppet A: 3 Position of puppet B: 2
	b)	Shadow of A is smaller than Shadow of B. A is further from the light source than B.
	c)	No, The screen was to allow some light to pass through for the shadows to be seen by the audience.

Q37) ii) Danny should add 20cm³ of water in the measuring cylinder then put the stone into the measuring cylinder and measure the volume of the water.

Q41.	a)	Volume of air – 270cm^3 Volume of water – 30cm^3
	b)	Vol. of water remains the same. Water has no definite volume.
	c)	increase

