



Maha Bodhi School
2022 Semestral Assessment 2
Primary 4
Mathematics
Booklet A

Name : _____ ()

Class : Primary 4 _____

Date : 27 October 2022

Total Duration for Booklets A and B: 1 h 45 min

INSTRUCTIONS TO CANDIDATES:

1. Do not turn over this page until you are told to do so.
2. Follow all instructions carefully.
3. Answer all questions.
4. Shade your answers in the Optical Answer Sheet (OAS) provided.

This booklet consists of 10 printed pages.

Section A (40 marks)

Questions 1 to 20 carry 2 marks each.

For each question, four options are given. One of them is the correct answer.

Make your choice (1, 2, 3 or 4) and shade your answer on the Optical Answer Sheet.

1. The value of the digit 4 in 74 521 is _____.

- (1) 40
- (2) 400
- (3) 4000
- (4) 40 000

2. Which of the following is not a factor of 45?

- (1) 5
- (2) 7
- (3) 3
- (4) 9

3. Which of the following fractions is in its simplest form?

- (1) $\frac{3}{6}$
- (2) $\frac{5}{7}$
- (3) $\frac{6}{9}$
- (4) $\frac{2}{10}$

4. The figure shown is made up of identical triangles.

What fraction of the figure is shaded?

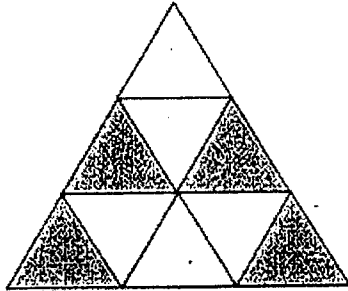

- (1) $\frac{4}{5}$
- (2) $\frac{5}{4}$
- (3) $\frac{4}{9}$
- (4) $\frac{5}{9}$
5. Express 0.08 as a fraction in its simplest form.

- (1) $\frac{1}{8}$
- (2) $\frac{1}{10}$
- (3) $\frac{4}{5}$
- (4) $\frac{2}{25}$

6.

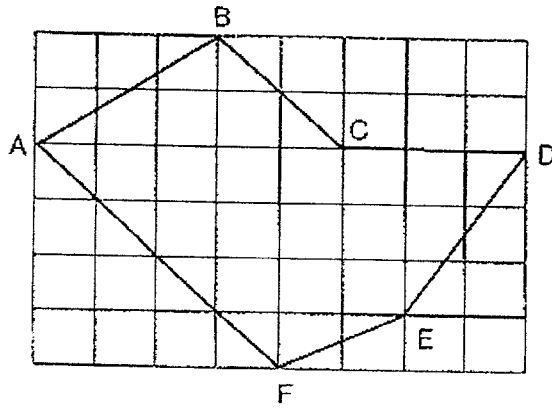
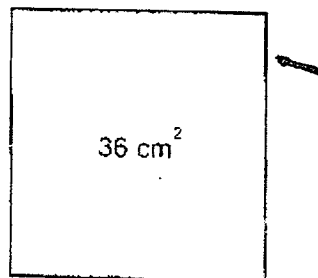

Figure ABCDEF is drawn on the square grid shown.
Which one of the following statements is true?

- (1) AB is parallel to ED.
- (2) BC is parallel to AF.
- (3) AB is perpendicular to BC.
- (4) AB is perpendicular to AF.

7. The figure below is a square and its area is 36 cm^2 .

Find the length of one side of the square.



- (1) 6 cm
- (2) 9 cm
- (3) 18 cm
- (4) 24 cm

8. What is the time shown on the clock?

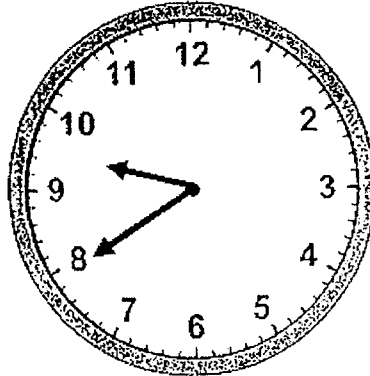

- (1) 8.09
(2) 8.47
(3) 9.08
(4) 9.40
9. A dress cost twice as much as a shirt.
Mrs Lim paid \$120 for 1 dress and 3 shirts.
What is the cost of 1 shirt?

- (1) \$24
(2) \$30
(3) \$72
(4) \$90

10. Which one of the following is equal to 0.49?

(1) $4 + \frac{9}{10}$

(2) $\frac{4}{10} + \frac{9}{10}$

(3) $\frac{4}{10} + \frac{9}{100}$

(4) $\frac{4}{100} + \frac{9}{100}$

11. Which of the following angles is the smallest?

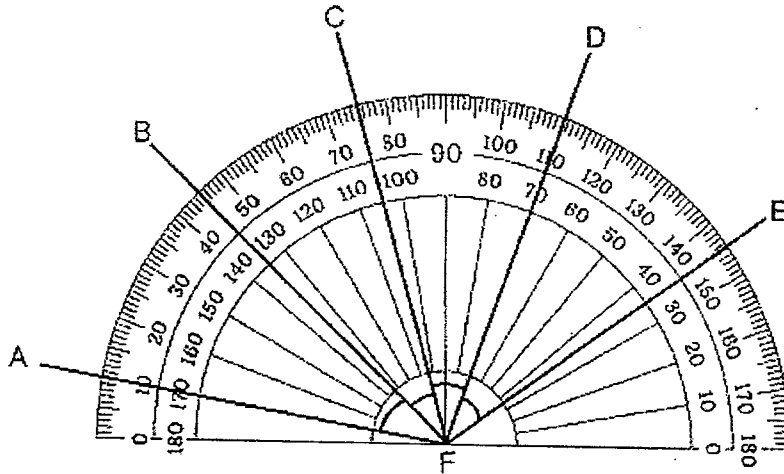

(1) $\angle AFB$

(2) $\angle BFC$

(3) $\angle CFD$

(4) $\angle DFE$

12. The following figures are each made up of 16 identical squares with 7 shaded squares.

Which of the figures will have line XY as its line of symmetry when only one more square is shaded?

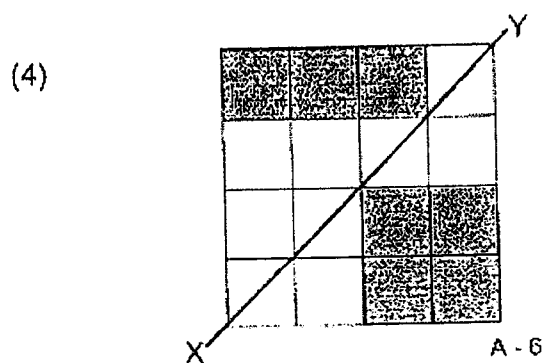
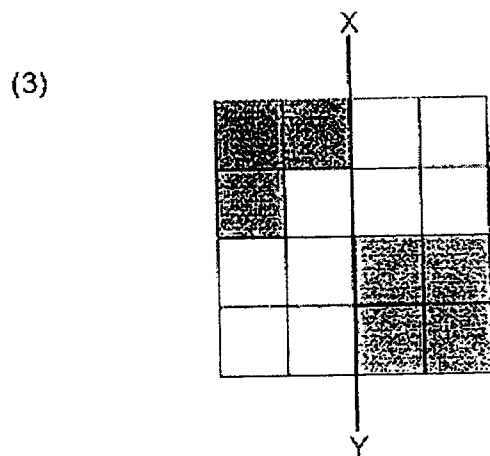
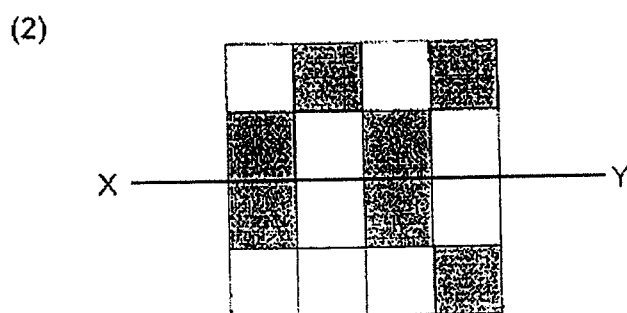
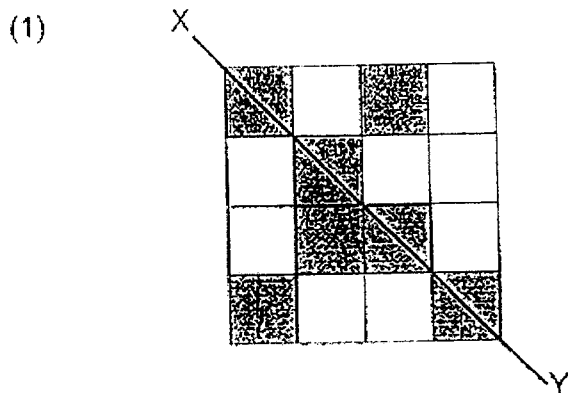

13. The figure below is made up of square A and square B.
 The length of one side of square B is 3 cm.
 The length of one side of square A is twice that of square B.
 Find the area of the figure.

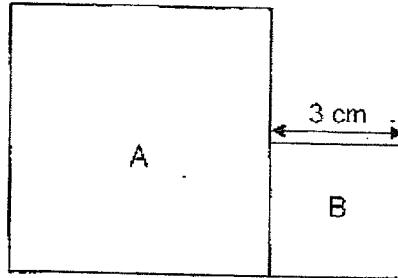

- (1) 9 cm²
 (2) 24 cm²
 (3) 36 cm²
 (4) 45 cm²
14. In the square grid below, X, Y and Z are composite figures.
 Arrange figures X, Y and Z from the smallest perimeter to the greatest.

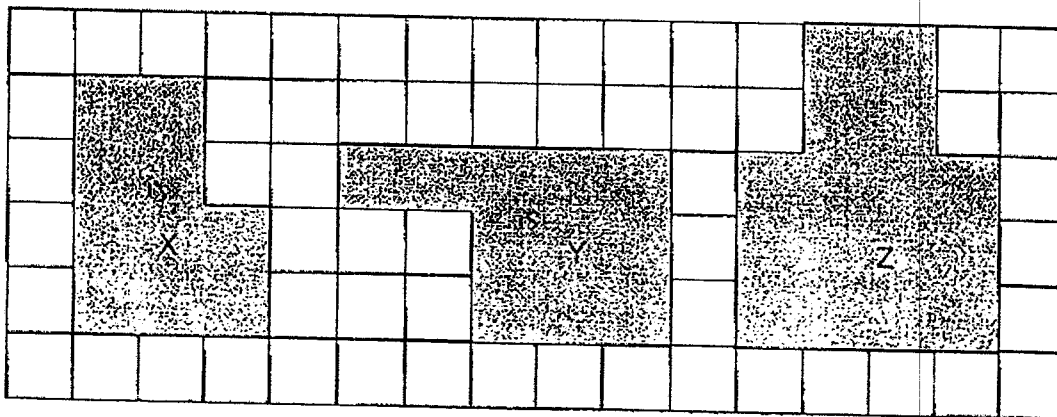

- | | <u>Smallest</u> | | <u>Greatest</u> |
|-----|-----------------|----|-----------------|
| (1) | X, | Y, | Z |
| (2) | Y, | X, | Z |
| (3) | Y, | Z, | X |
| (4) | Z, | Y, | X |

Study the bar graph and answer questions 15 and 16.

The bar graph shows the number of bottles a group of pupils collected during a recycling week.

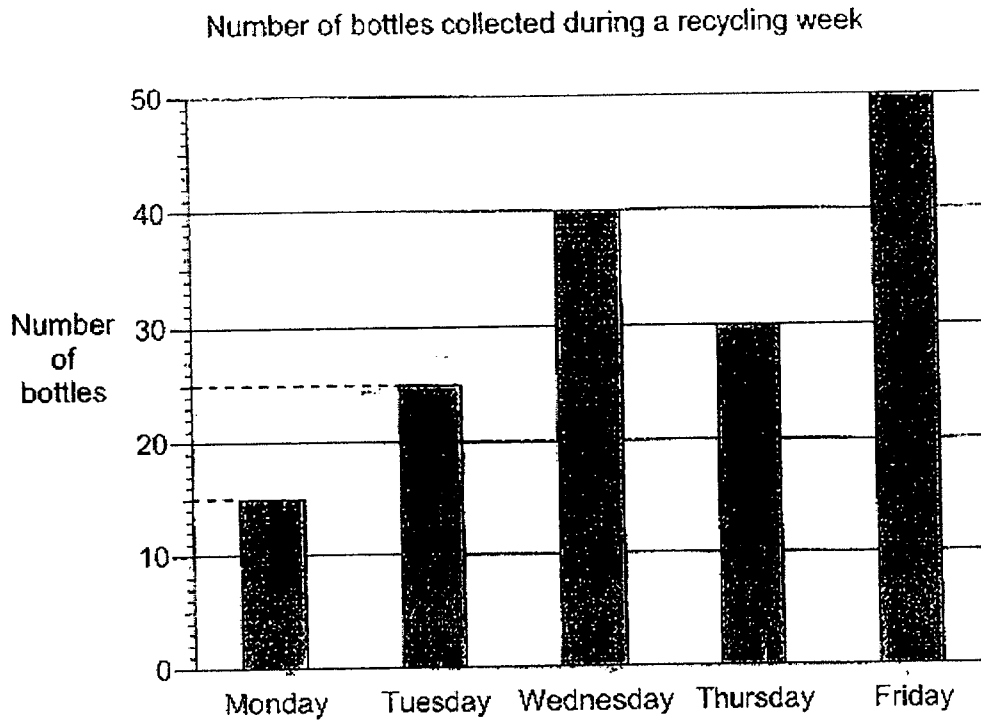

15. On which day was the number of bottles collected $\frac{3}{5}$ of the number collected on Friday?

- (1) Monday
- (2) Tuesday
- (3) Wednesday
- (4) Thursday

16. On which two days was a total of 40 bottles collected?
- (1) Monday and Tuesday
 - (2) Monday and Thursday
 - (3) Tuesday and Wednesday
 - (4) Tuesday and Thursday
17. In a game, 2 bonus tokens were given for every 5 tokens won.
Larry collected a total of 150 tokens.
How many bonus tokens was he given?
- (1) 21
 - (2) 24
 - (3) 32
 - (4) 42
18. Cindy had an equal number of red and yellow beads at first.
She gave away 50 beads.
She had $\frac{1}{3}$ of the red beads and $\frac{5}{6}$ of the yellow beads left.
How many more yellow beads than red beads did she have in the end?
- (1) 10
 - (2) 30
 - (3) 60
 - (4) 70

19. Figure 1 shows a rectangular card with a perimeter of 8 cm.
Figure 2 is formed using 3 such cards.
What is the perimeter of Figure 2?



Figure 1

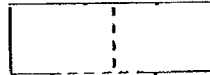

Figure 2

- (1) 12 cm
(2) 14 cm
(3) 16 cm
(4) 24 cm

20. The table below shows the timing each child took to complete a race.

Name of Child	Timing (s)
Aloysius	80.4
Daryl	77.9
Jerine	79.6
Mandy	78.5

Who came in second in the race?

- (1) Aloysius
(2) Daryl
(3) Jerine
(4) Mandy



Remember to check your work!

~ End of Booklet A ~



Maha Bodhi School
2022 Semestral Assessment 2
Primary 4
Mathematics
Booklet B

Name : _____ ()

Class : Primary 4 _____

Date : 27 October 2022

Total Duration for Booklets A and B: 1 h 45 min

INSTRUCTIONS TO CANDIDATES:

Booklet	Marks Obtained	Max Marks
A		40
B		60
Total		100

Parent's signature: _____

This booklet consists of 14 printed pages.

1

Section B (40 marks)

Questions 21 to 40 carry 2 marks each.

Show your working clearly and write your answers in the spaces provided.
For questions which require units, give your answers in the units stated.

21. Write thirteen thousand and ninety-two in figures.

Ans: _____

22. Write the missing number in the number pattern below.

14 000, 13 600, 13 200, 12 800, _____, 12 000

Ans: _____

23. $1386 \div 9 =$ _____

Ans: _____

24. How many one-eighths are there in 1 whole?

Ans: _____

25. $\frac{5}{6} = \frac{\square}{18}$

What is the missing number in the box?

Ans: _____

26. Write 7 tenths as a decimal.

Ans: _____

27. Arrange the following numbers from the smallest to the greatest.

$$\frac{2}{5}, 0.502, 0.052$$

Ans: _____, _____, _____
(smallest) (greatest)

28. Round 18.57 to the nearest whole number.

Ans: _____

29. In the figure shown, ABCD is a rectangle. Find $\angle EDF$.

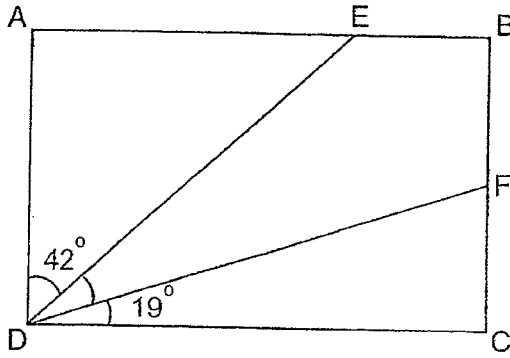

Ans: _____°

30. The bar graph below shows the number of fruits sold at a shop.

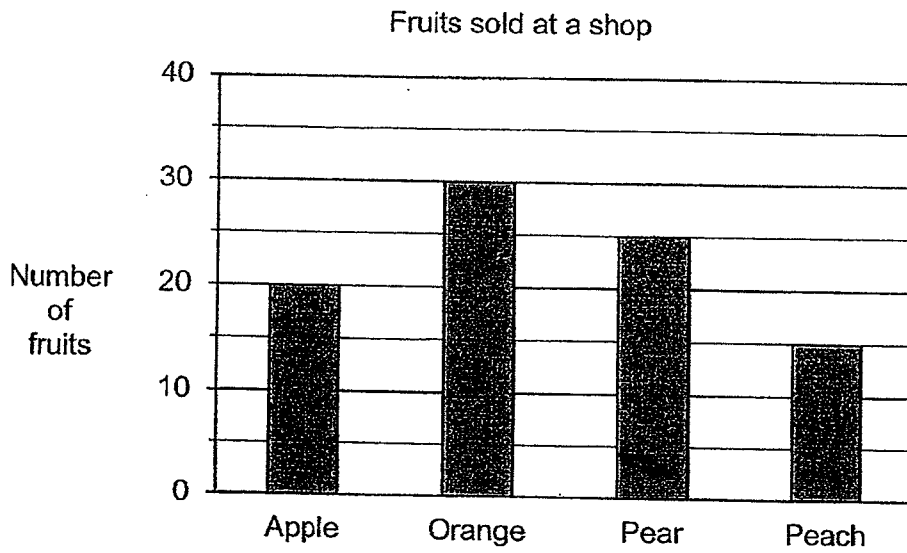

How many apples and pears were sold altogether?

Ans: _____

31. Mrs Chan is 5 times as old as her daughter now.
Three years ago, her daughter was 7 years old.
How old is Mrs Chan now?

Ans: _____

32. Weiling bought a total of 41 green and blue ice-cream sticks.
She bought 15 more green ice-cream sticks than blue ice-cream sticks.
How many blue ice-cream sticks did Weiling buy?

Ans: _____

33. Use the digits 3, 0, 6 and 8 to form the greatest decimal with 3 decimal places.

Ans: _____

34. The figure shows a road map.

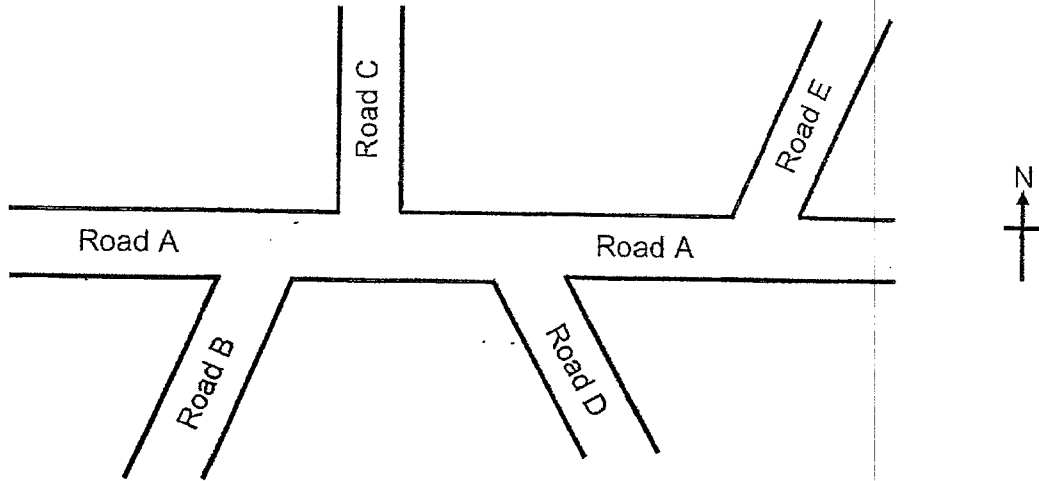

A car moved along Road A.

After the car turned into another road, it faced north-east.

Which road did it turn into?

Ans: _____

35. In the figure, Jenny is standing in one of the squares.
 She is standing south-west of the food centre and east of the school.
 Put a tick (✓) in the square where Jenny is standing.

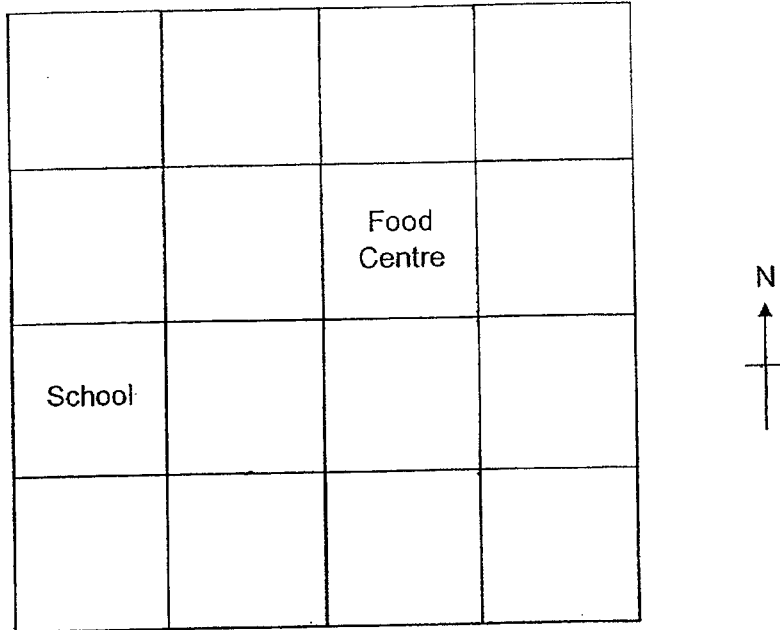

36. Study the pattern below. Which letter is in the 70th position?

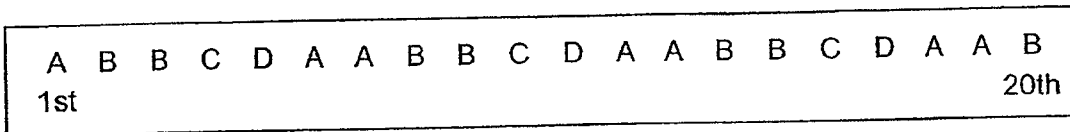

Ans: _____

37. The bracelet below shows the number of beads left after the string broke. Six black beads went missing. What fraction of the beads went missing? Write your answer in the simplest form.

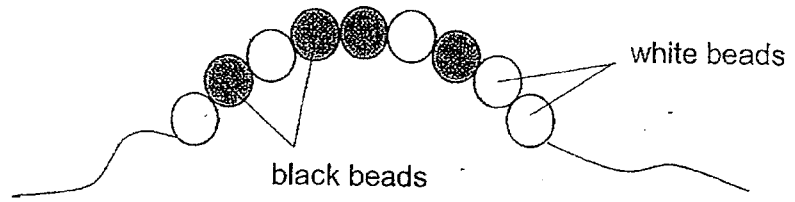

Ans: _____

38. In the figure below, ABCD is a square and DEFH is a rectangle. Find $\angle x$.

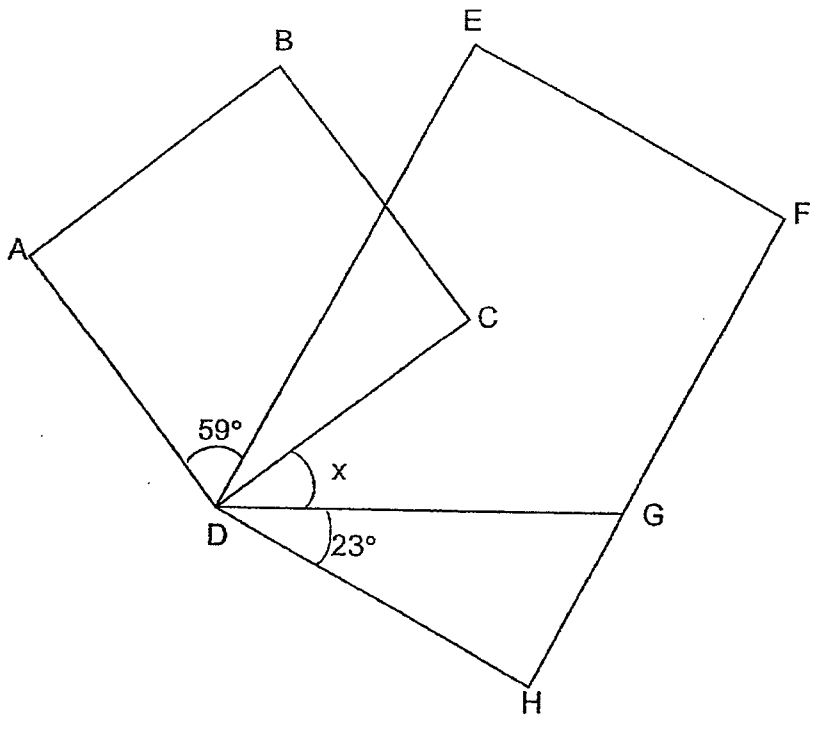

Ans: _____^o

39. The figure below is made up of square A, rectangle B and square C.
The area of square A is 64 cm^2 .
The area of rectangle B is 72 cm^2 .
Find the area of square C.

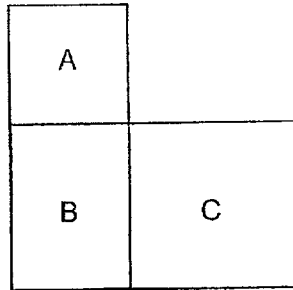

Ans: _____ cm^2

40. The line graph below shows the number of parcels delivered by Terry in a week.

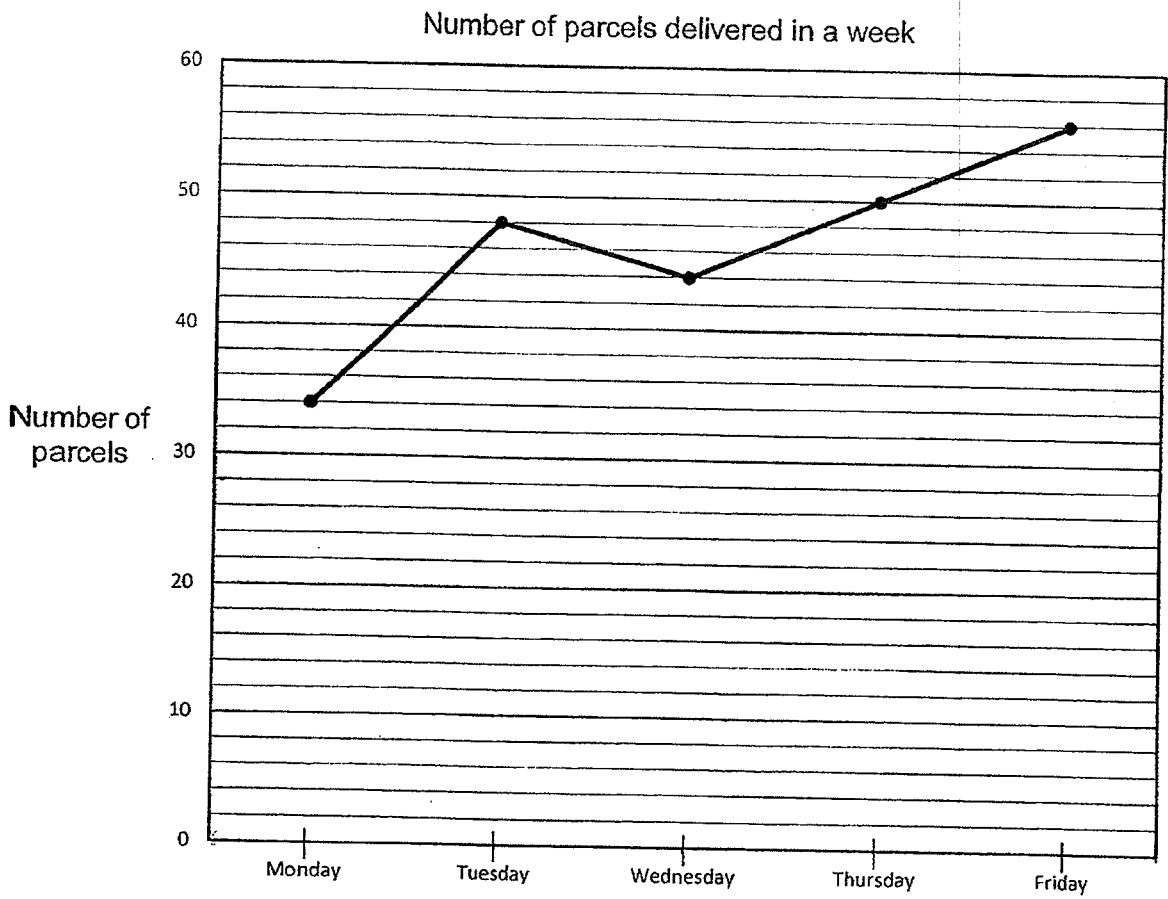

Terry earns \$1 for each parcel delivered.
For every 50 parcels delivered in a week, Terry earns an additional bonus of \$5.
How much did Terry earn in this week?

Ans: \$ _____

Section C (20 marks)

Questions 41 to 45 carry 4 marks each.

Show your working clearly in the space provided for each question and write your answers in the spaces provided. For questions which require units, give your answers in the units stated. The number of marks available is shown in brackets [] at the end of each question or part-question.

41. Henry, Paul and James had 386 marbles altogether.
Paul had twice as many marbles as James.
Henry had 30 marbles less than James.

(a) How many marbles did James have?

Ans: (a) _____ [2]

(b) How many marbles did Henry and Paul have altogether?

Ans: (b) _____ [2]

42. Mary used some ribbons to complete an art work.

She used $\frac{1}{4}$ m of the ribbon on the first day.

She used $\frac{5}{8}$ m more ribbon on the second day than on the first day.

Find the total length of ribbon she used on the two days.

Express your answer as a mixed number in its simplest form.

Ans: _____ [4]

43. Sam has 2 strings and 5 ribbons.

The total length of the strings and ribbons is 9.12 m.

Each string is 1.9 m longer than a ribbon.

What is the length of one ribbon?

Ans: _____ [4]

44. Nigel travelled from Town A to Town B.
He left Town A at 10 45 and reached Town B at 13 10.
(a) How long did he take to travel from Town A to Town B?

Ans: (a) _____ [2]

- (b) Nigel stayed in Town B for 30 min.
He then took 4 h 15 min to travel from Town B to Town C.
At what time did he reach Town C?

Ans: (b) _____ [2]

45. 4 files and 2 writing pads cost \$11.60.

8 files and 6 writing pads cost \$26.

What is the cost of 1 writing pad?

Ans: _____ [4]

/ 4



Remember to check your work!

~ End of Paper ~

SCHOOL : MAHA BODHI PRIMARY SCHOOL
 LEVEL : PRIMARY 4
 SUBJECT : MATHEMATICS
 TERM : 2022 SA2

PAPER 1 BOOKLET A

Q 1	Q2	Q3	Q4	Q5	Q6	Q7	Q8	Q9	Q10
3	2	2	3	4	2	1	4	1	3
Q 11	Q12	Q13	Q14	Q15	Q16	Q17	Q18	Q19	Q20
2	2	4	1	4	1	4	2	3	4

PAPER 1 BOOKLET B

Q21)	13092
Q22)	12400
Q23)	154
Q24)	eight
Q25)	15
Q26)	0.7
Q27)	0.052 , $\frac{2}{5}$, 0.502
Q28)	19
Q29)	$42 + 19 = 61$ $90 - 61 = 29^\circ$
Q30)	$20 + 25 = 45$
Q31)	$7 + 3 = 10$ $10 \times 5 = 50$
Q32)	$41 - 15 = 26$ $26 \div 2 = 13$
Q33)	8.630
Q34)	Road E

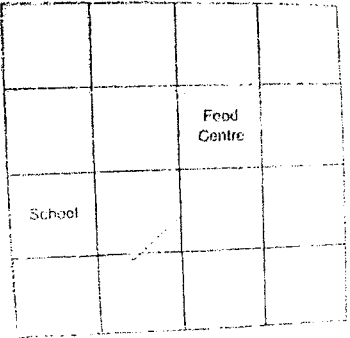
Q35)	
Q36)	C
Q37)	$\frac{2}{5}$
Q38)	$90 - 59 = 31$ $31 + 23 = 54$ $90 - 54 = 36^\circ$
Q39)	$8 \times 8 = 64$ $72 \div 8 = 9$ $9 \times 9 = 81\text{cm}^2$
Q40)	$34 + 48 + 44 + 50 + 56 = 232$ $232 \div 50 = 4\text{R}32$ $4 \times 5 = 20$ $232 + 20 = \$252$
Q41)	a) $386 + 30 = 416$ $416 \div 4 = 104$ b) $104 \times 2 = 208$ $104 - 30 = 74$ $208 + 74 = 282$
Q42)	$\frac{1}{4} + \frac{5}{8} = \frac{2}{8} + \frac{5}{8}$ $\frac{2}{8} + \frac{7}{8} = 1\frac{1}{8}\text{m}$
Q43)	$1.9 \times 2 = 3.8$ $9.12 - 3.8 = 5.32$ $5.32 \div 7 = 0.76\text{m}$
Q44)	a) 2h25min b) 1755
Q45)	$\$26 - \$11.60 = \$14.40$ $\$14.40 - \$11.60 = \$2.80$ $\$2.80 \div 2 = \1.40