

Name: _____ ()

Class: Primary 6 _____

CHIJ ST NICHOLAS GIRLS' SCHOOL (PRIMARY)

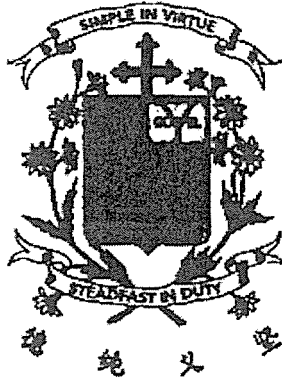

Primary 6 Mathematics

2023 Preliminary Examination

Paper 1

Booklet A

21 August 2023

**15 questions
20 marks**

Total Time for Booklets A and B: 1 hour

INSTRUCTIONS TO CANDIDATES

Do not turn over this page until you are told to do so.
Follow all instructions carefully.
Answer all questions.
Write your answers in this booklet.
The use of calculators is **NOT** allowed.

This booklet consists of 10 printed pages.

Questions 1 to 10 carry 1 mark each. Questions 11 to 15 carry 2 marks each. For each question, four options are given. One of them is the correct answer. Make your choice (1, 2, 3 or 4). Shade the correct oval (1, 2, 3, or 4) on the Optical Answer Sheet. (20 marks)

1. Which one of the following is one million, three hundred thousand and seventy in figures?

- (1) 1 003 070
- (2) 1 003 700
- (3) 1 300 070
- (4) 1 300 700

2. Which one of the following when rounded to the nearest thousand is 60 000?

- (1) 59 097
- (2) 59 483
- (3) 60 123
- (4) 60 599

3. Abraham invested \$18 000 in an investment fund. The bank paid 4% interest at the end of each year. How much interest did he earn at the end of 1 year?

- (1) \$18 720
- (2) \$17 280
- (3) \$7200
- (4) \$720

4. The table below shows the time taken by 4 swimmers in a competition. Who is the fastest swimmer?

| Swimmer | Balan | Carson | Darvesh | Ee Yong |
|------------------|-------|--------|---------|---------|
| Time taken (min) | 4.2 | 4.02 | 4.28 | 4.1 |

- (1) Balan
- (2) Carson
- (3) Darvesh
- (4) Ee Yong

5. Figera has two 10 ¢ coins, six 20 ¢ coins and three 50 ¢ coins. What is the least number of coins that she can use to make \$2?

- (1) 6
- (2) 5
- (3) 3
- (4) 4

6. Identical cubes were glued together to form the 4 solids, A, B, C and D.



A

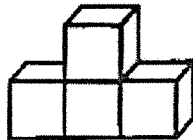

B

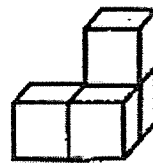

C

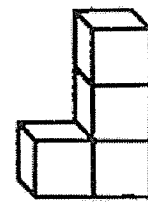

D

Which 2 solids could be joined to form the solid below?

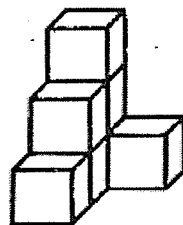

- (1) A and B
- (2) A and D
- (3) B and C
- (4) C and D

7. The figure below shows a cube.

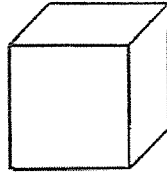

Which one of the following faces, P, Q, R or S in the figure is not part of the net of the cube ?

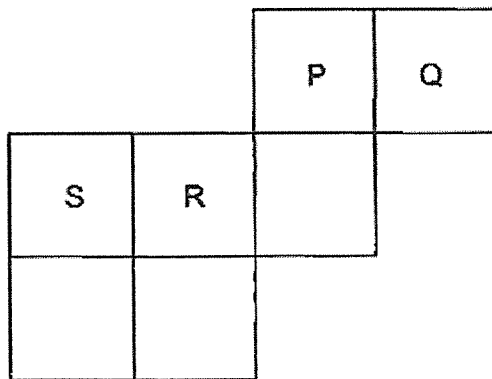

- (1) P
- (2) Q
- (3) R
- (4) S

8. Gayatri is standing at point Q facing the market. Which place will she be facing if she turns 225° anti-clockwise?

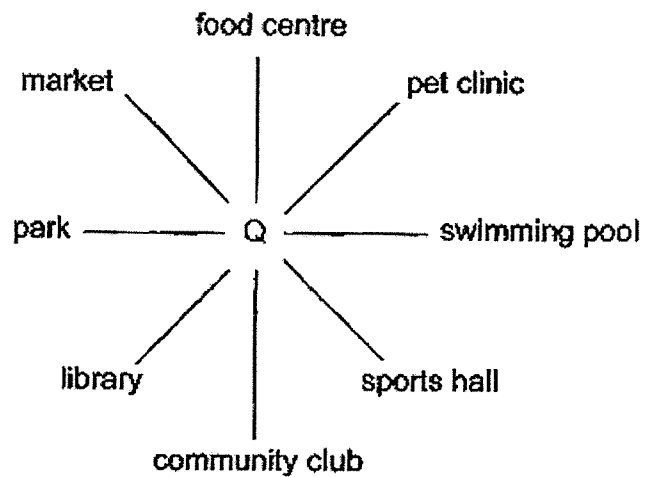

- (1) park
(2) library
(3) swimming pool
(4) community club
9. The sum of 6 numbers is 70. The average of 4 of the numbers is 12. What is the sum of the remaining numbers?

- (1) 11
(2) 22
(3) 29
(4) 58

10. A group of workers was asked to vote for their favourite food, carrot cake, mee siam and nasi lemak. The pie chart shows the workers' choices. The workers' choices were also represented by 4 graphs. Which of the following graphs best represents the information in the pie chart?

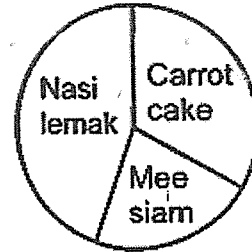

(1)

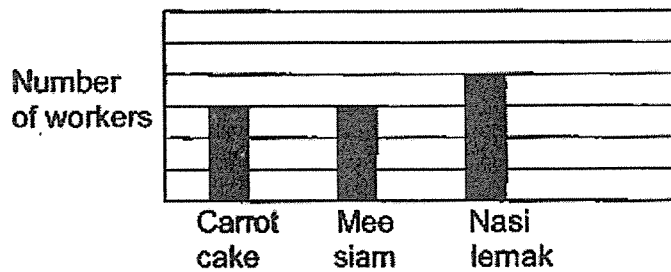

(2)

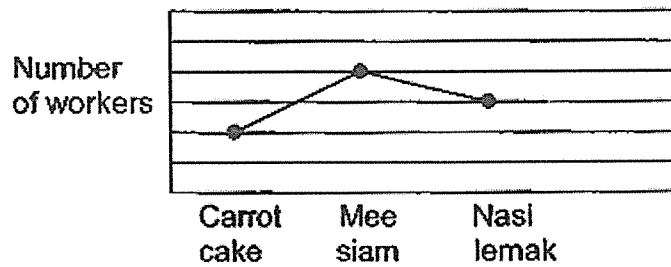

(3)

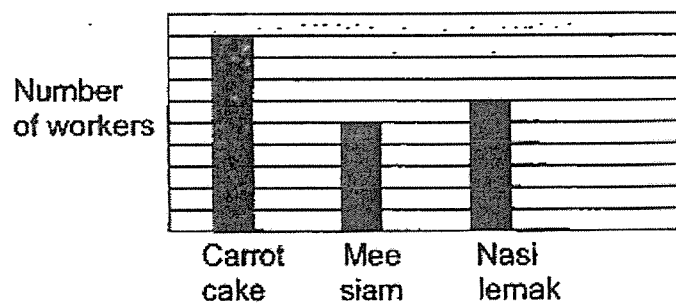

(4)

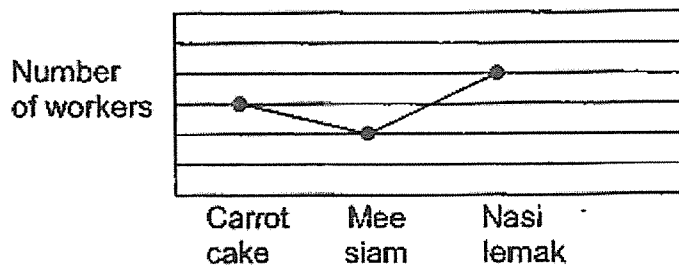

11. The table below shows the number of families with different number of children in a block of flats. There are 300 children altogether.

| Number of children per family | 0 | 1 | 2 | 3 | 4 |
|-------------------------------|----|----|----|---|----|
| Number of families | 15 | 23 | 51 | ? | 10 |

How many families are there with 3 children each?

- (1) 40
(2) 45
(3) 120
(4) 135
12. One sandwich costs 5 times as much as one pie. Iker has just enough money to buy four such sandwiches and eight such pies. However, he only wants to buy pies, What is the greatest number of pies he can buy with $\frac{3}{5}$ of his money?

- (1) 15
(2) 16
(3) 17
(4) 18

13. The figure below is formed by 3 big identical equilateral triangles and 3 small identical equilateral triangles. The length of GH is 54 cm. What is the perimeter of the figure?

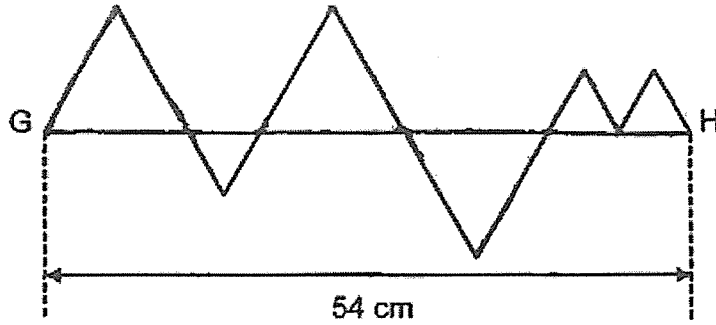

- (1) 162 cm
 (2) 324 cm
 (3) 486 cm
 (4) 972 cm
14. During an enrichment lesson, each pupil in a class was given either 2 or 3 dice. The ratio of the number of pupils to the number of dice given was 9 : 23. What fraction of the pupils were given 2 dice each?

- (1) $\frac{4}{9}$
 (2) $\frac{5}{9}$
 (3) $\frac{5}{14}$
 (4) $\frac{9}{14}$

15. Figure X is a trapezium and Figure Y is a parallelogram. Which pair of the following statements is true?

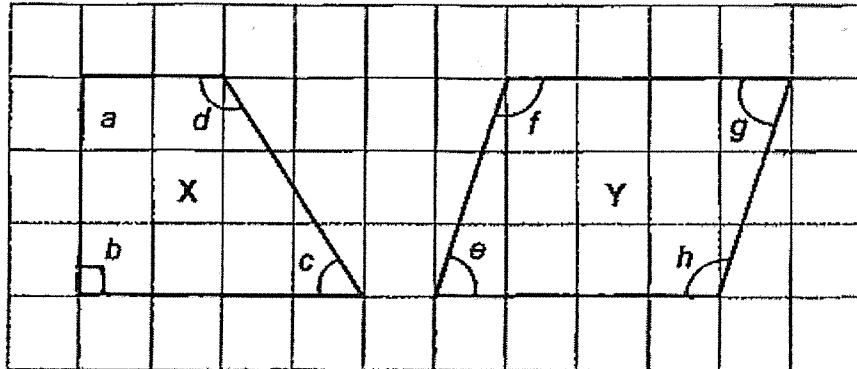

| | Figure X | Figure Y |
|-----|-------------------------------------|---|
| (1) | Opposite sides are parallel | Opposite sides are parallel |
| (2) | Has one pair of perpendicular lines | Does not have any pair of perpendicular lines |
| (3) | $\angle c + \angle d = 180^\circ$ | $\angle f + \angle h = 180^\circ$ |
| (4) | $\angle a + \angle b = 180^\circ$ | $\angle e + \angle h = 180^\circ$ |

Name: _____ ()

Class: Primary 6 _____

CHIJ ST NICHOLAS GIRLS' SCHOOL (PRIMARY)



**Primary 6 Mathematics
2023 Preliminary Examination**

Paper 1

Booklet B

21 August 2023

| | |
|-----------------|----|
| Booklet A | 20 |
| Booklet B | 25 |
| Total (Paper 1) | 45 |

15 questions
25 marks

Total Time for Booklets A and B: 1 hour

INSTRUCTIONS TO CANDIDATES

Do not turn over this page until you are told to do so.
Follow all instructions carefully.
Answer all questions.
Write your answers in this booklet.
The use of calculators is **NOT** allowed.

This booklet consists of 11 printed pages.

Questions 16 to 20 carry 1 mark each. Show your working clearly and write your answers in the spaces provided. For questions which require units, give your answers in the units stated. (5 marks)

Do not write in this space

16. The total height of a doll and a box is 1.09 m. The height of the box is more than 0.2 m but less than 0.9 m. It is a decimal with 2 decimal places. Write down a possible height of the doll.

Ans: _____ m

17. Find the value of $3 - \frac{1}{8}$. Leave your answer as a mixed number in the simplest form.

Ans: _____

18. 60% of a number is 150. What is the number?

Ans: _____

| |
|--|
| |
|--|

19. What is the length of the arrow?

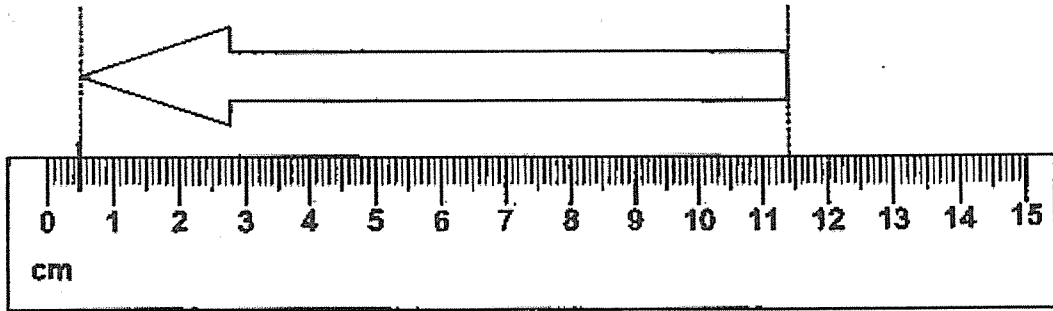

Do not
write
in this
space



Ans: _____ cm

3

MARKS:

20. The table shows the number of Primary 6 pupils who had their weight measured. Some information was smudged with ink.

Do not write in this space

| Category | Number of boys | Number of girls | Number of Primary 6 pupils who had their weight measured |
|----------------------------------|----------------|--|--|
| Underweight | 15 | 19 | 34 |
| Acceptable Weight | 118 | 97 |  |
| Overweight | 11 |  |  |
| Total number of Primary 6 Pupils | | | 276 |

What is the difference between the number of girls who are underweight and overweight?

Ans: _____

Questions 21 to 30 carry 2 marks each. Show your working clearly and write your answers in the spaces provided. For questions which require units, give your answers in the units stated. (20 marks)

Do not write in — this space

21. The pie chart represents the number of the different flavours of cakes in a bakery. What is the total number of blueberry cakes and mango cakes?

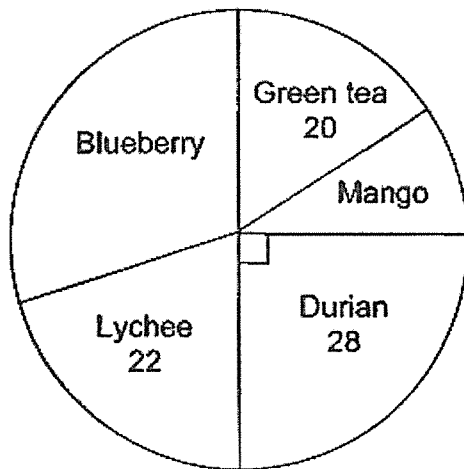

Ans: _____

22. A bowl cost $\$r$ and a pot cost $\$14r$. Jacie bought 7 such bowls and 1 pot. She had $\$30$ left. How much money did she have at first? Leave your answer in terms of r .

Ans: \$ _____

| |
|--|
| |
|--|

23. In the figure, $PQ = PS$ and QR is a straight line Find $\angle RQS$.

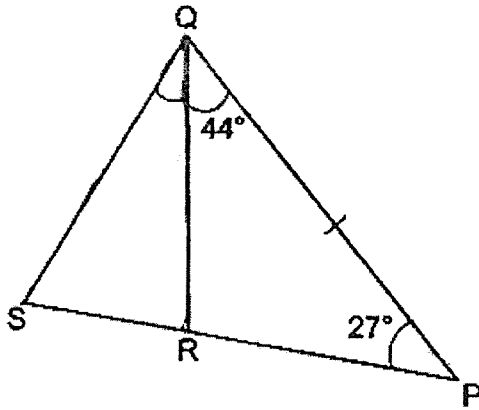

Ans: _____ °

24. Complete the figure below to form a symmetric figure. WX is the line of symmetry.

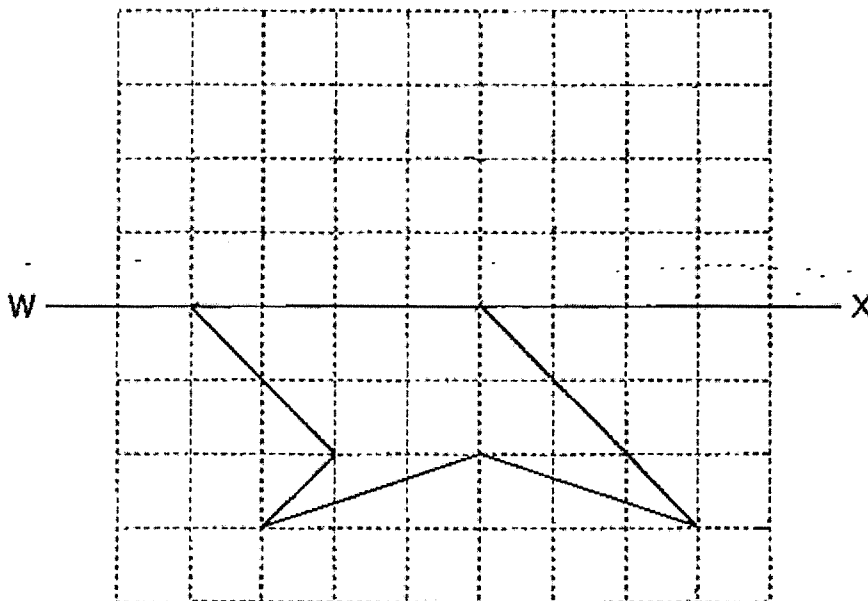

Do not
write
in this
space

25. Nathim's present age is a factor of 72. Two years ago, his age was a multiple of 4. Write down the possible present of ages Nathim.

Do not
write in
this space

Ans: _____

26. Ko Sheen took a total of 10 minutes to jog 5 rounds. Each round was 0.4 km. Find her average speed for the 5 rounds.

Ans: _____ m / min

| |
|--|
| |
|--|

27. Leroy was $\frac{1}{5}$ h late for a musical. He watched the musical for 1 h 38 min before it ended at 3.15 p.m.

Do not write in this space

(a) For how many minutes was Leroy late for the musical?

Ans: (a) _____ min

(b) At what time did the musical start?

Ans: (b) _____ p.m.

| |
|--|
| |
|--|

28. The line graph shows the number of text messages Marco received each day from Tuesday to Friday.

Do not write in this space

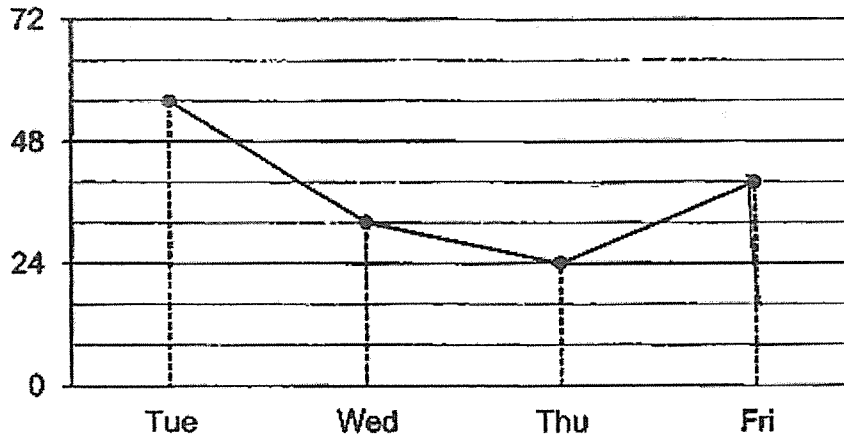

On which day was the number of messages Marco received the closest to the average number of messages he received from Tuesday to Friday?

Ans: _____

29. In the morning, Uncle Nong had more toy cars than toy boats at his shop at first. In the afternoon, he sold $\frac{1}{2}$ of the number of toy cars and 6 toy boats. He did not sell all the toy boats.

Do not write in this space

Each statement below is either true, false or not possible to tell from the information given. For each statement, put a tick (✓) in the correct column.

| Statement | True | False | Not possible to tell |
|---|------|-------|----------------------|
| In the morning, Uncle Nong had a total of 13 toy cars and toy boats at first. | | | |
| In the afternoon, Uncle Nong had more toy cars than toy boats left. | | | |
| The least possible difference between the number of toy cars and toy boats Uncle Nong had left was 5. | | | |

| |
|--|
| |
|--|

30. In the figure below, $ACEG$ is a rectangle and $ABJH$ is a square. The area of the shaded rectangle $JDEF$ is 36 cm^2 and the length of HG is 9 cm . Find the length of AC .

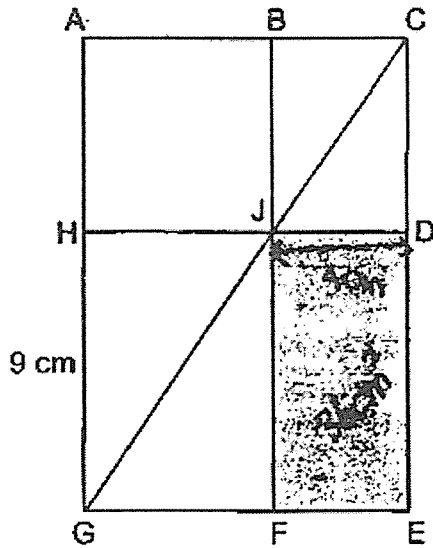

Do not write in this space

Ans: _____ cm

End of Paper

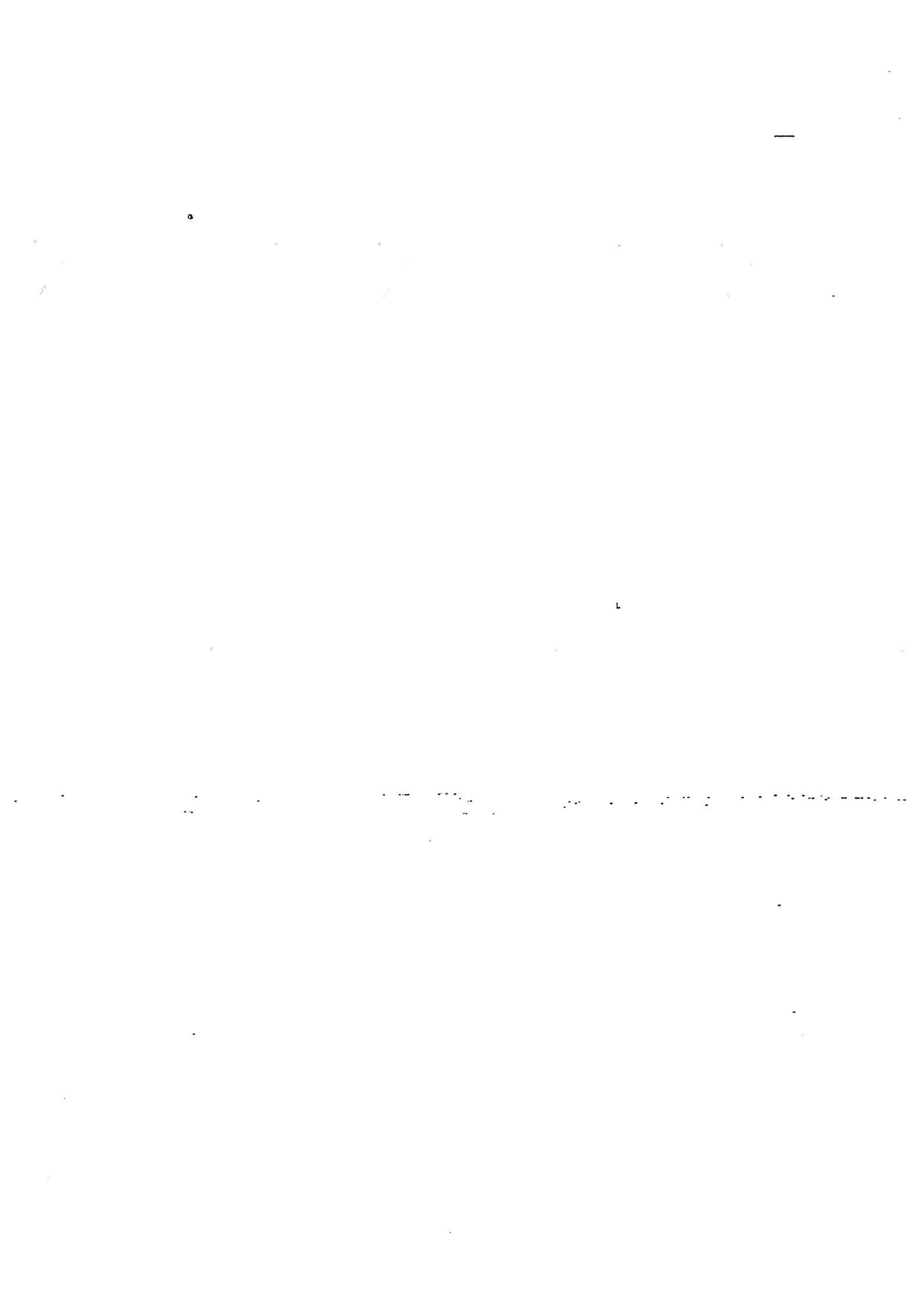

Name: _____ ()

Class: Primary 6 _____

CHIJ ST NICHOLAS GIRLS' SCHOOL (PRIMARY)

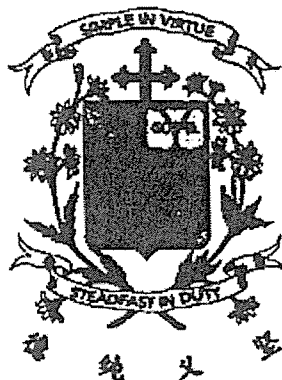

Primary 6 Mathematics

2023 Preliminary Examination

Paper 2

21 August 2023

| | |
|-------------|-----|
| Paper 1 | 45 |
| Paper 2 | 55 |
| Total Marks | 100 |

Parent's/Guardian's Signature

Time : 1 hour 30 minutes

INSTRUCTIONS TO CANDIDATES

Do not turn over this page until you are told to do so.

Follow all instructions carefully.

Answer all questions.

Write your answers in this booklet

The use of an approved calculator is expected, where appropriate.

This booklet consists of 18 printed pages.

Questions 1 to 5 carry 2 marks each. Show your working clearly and write your answers in the spaces provided. For questions which require units, give your answers in the units stated. (10 marks)

Do not write in this space

1. Adora had 45 magnets at first. She bought some more magnets. Then she shared what she had bought equally between herself and her cousin. In the end, Adora had 69 magnets. How many magnets did Adora buy?

Ans : _____

2. The figure shows 4 identical triangles inside a square. The perimeter of the square is 280 cm.

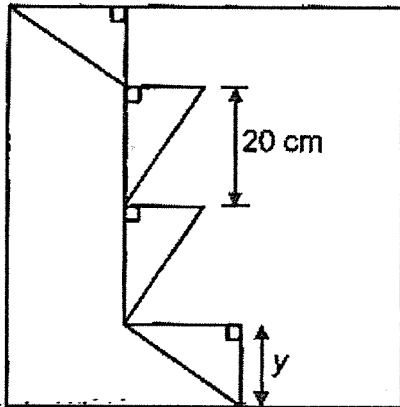

- (a) What is the length of y ?

Ans : (a) _____ cm

- (b) The 4 triangles are then cut from the square. What is the area of the remaining figure?

Ans : (b) _____ cm^2



3. The figure below shows a parallelogram ABCD drawn on a grid.

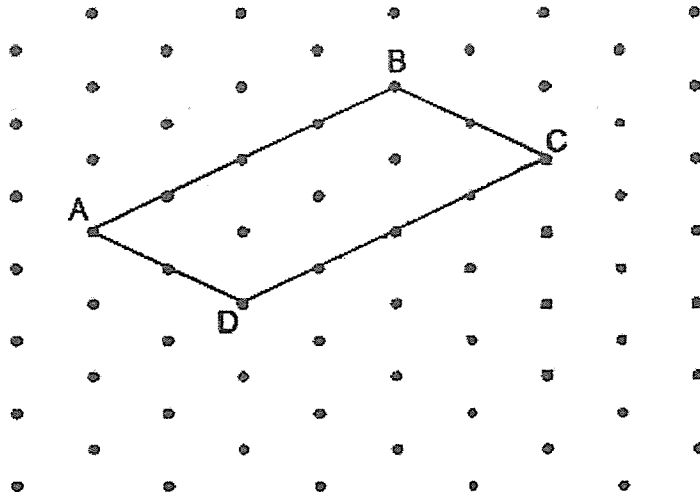

Do not
write
in this
space

By joining dots on the grid with straight lines,

(a) draw triangle FCE such that FCE is an acute-angled triangle.
CE is shorter than AB and $CE = EF$.

(b) draw rhombus GHJK such that F is the centre of GHJK.

Use a pencil to draw your diagrams and label them clearly.



4. In the figure, KN and JL are straight lines. LPK is an equilateral triangle and $JK \parallel ML$. The sum of $\angle MJL$ and $\angle LMJ$ is 138° . Find $\angle QLP$.

Do not
write
in this
space

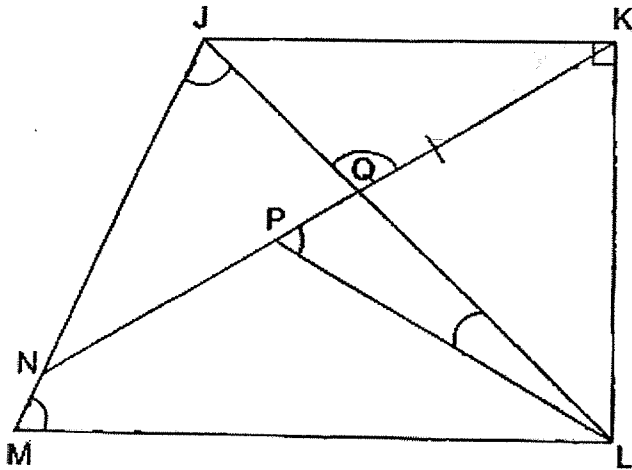

Ans : _____^o



5. A tank was $\frac{1}{3}$ filled with water at 4 p.m. Water flowed out of the tank from 4 p.m. to 9 p.m.. The amount of water that flowed out of the tank is not shown on the scale.

Do not write in this space

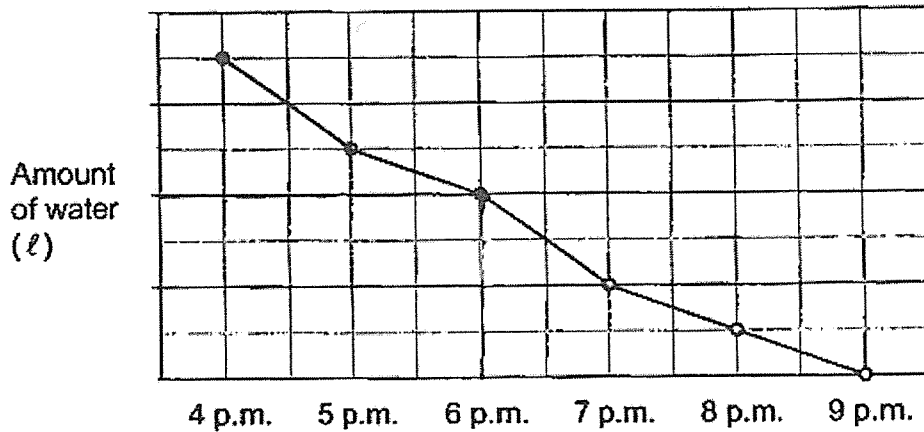

- (a) From 5 p.m. to 9 p.m., 125ℓ of water flowed out of the tank. What is the capacity of the tank?

Ans : (a) _____ cm³ [1]

- (b) At what time was 100ℓ of water left in the tank?

Ans : (b) _____ p.m. [1]

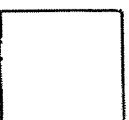

For questions 6 to 17, show your working clearly and write your answers in the spaces provided. The number of marks available is shown in the brackets () at the end of each question or part-question. (45 marks)

Do not write in this space

6. The table shows the prices of 5 items.

| Item | Price (\$) |
|--------------|------------|
| Cap | 4.00 |
| Towel | 0.90 |
| Haversack | 8.90 |
| Water bottle | 17.50 |
| Sleeping bag | 16.50 |

(a) Of the 5 items, Glynis bought 3 of them and Levivia bought the remaining items. The items each of them bought were different. Glynis spent \$11 more than Levivia. How much money did Glynis spend on the 3 items?

Ans : (a) _____ [1]

(b) What was the cheapest item each of them bought?

Ans : (b) Glynis → _____

Levivia → _____ [2]



7. At first, there were some children and 132 adults at a party. $\frac{6}{11}$ of the adults left the party. Then another 14 children joined in the party. In the end, the number of adults who remained at the party was the same as the number of children.

Do not
write
in this
space

(a) How many adults remained at the party?

Ans : (a) _____ [1]

(b) How many people were there at the party at first?

Ans : (b) _____ [2]



8. A group of singers are arranged in 5 rows. There are 7 singers in the second row. Each row has n more singers than the row in front of it.
- (a) How many singers are there in the first row? Leave your answer in terms of n .

Do not write in this space

Ans : (a) _____ [1]

- (b) Given that there are 13 singers in the fourth row, find the value of n .

Ans : (b) _____ [1]

- (c) How many singers are there altogether in the 5 rows?

Ans : (c) _____ [1]



9. Zhi Cong can type 90 words in every 2 minutes. He tends to type 9 words incorrectly every 10 minutes.

(a) At this rate, how many words can Zhi Cong type altogether in 2 hours?

Ans : (a) _____ [1]

(b) What is the total number of words he can type correctly in 2 hours?

Ans : (b) _____ [2]

Do not
write
in this
space



10. The figure is made up of a semicircle, a large circle and a small circle. O is the centre of the semicircle and the large circle. X is the centre of the small circle. $OP = 56$ cm.

Do not write in this space

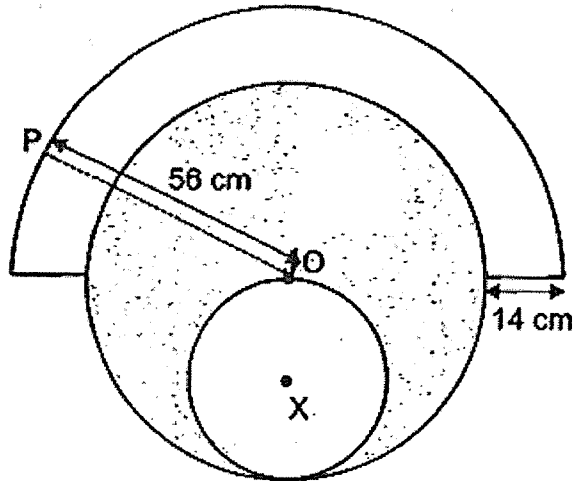

Use the calculator value of π to find the perimeter of the unshaded parts correct to 2 decimal places.

Ans : _____ [3]



11. $ABCD$ is a rectangle. AE and DG are straight lines. $\angle ADF = \angle FDE$.

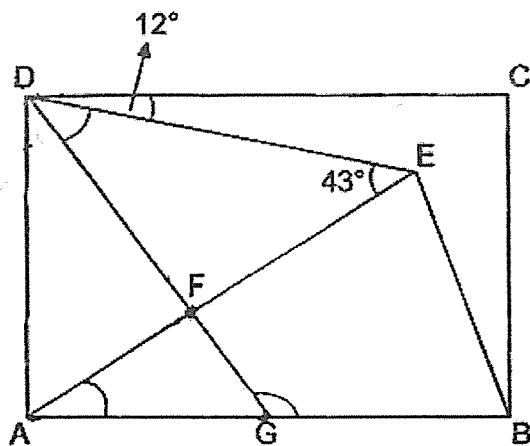

(a) Find $\angle FDE$.

Ans : (a) _____ [1]

(b) Find $\angle BGD$.

Ans : (b) _____ [1]

(c) Find $\angle FAG$.

Ans : (c) _____ [1]

Do not
write
in this
space



12. On Saturday, Mr Zusin sold five different types of items. He prepared 66 of each item at the start of Saturday. He sold every item at the same price. The bar graph shows the number of items sold on Saturday.

Do not write in this space

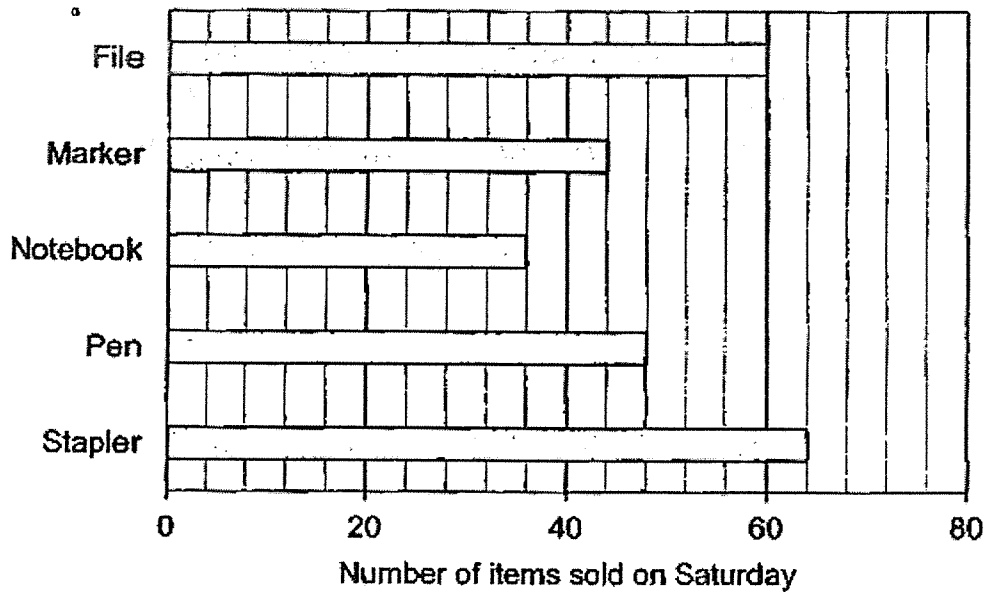

- (a) Which item had the most number left unsold at the end of Saturday?

Ans : (a) _____ [1]

- (b) On Saturday, Mr Zusin sold the pens at \$1.95 each. How much money did he collect?

Ans : (b) _____ [1]

- (c) On Sunday, Mr Zusin continued to sell the remaining unsold items from Saturday at any 3 for \$5. He sold all the items. How much money did he collect on Sunday?

Ans : (c) _____ [2]



13. The admission tickets for children to watch a magic show were fixed on all days of a week. On Thursday, there were 80 boys and 60 girls at the show. On Friday, the number of boys increased by 30% and the number of girls decreased by 15%. Altogether, \$9440 was collected from the sale of admission tickets over the two days.

Do not write in this space

(a) What was the price of each admission ticket?

Ans : (a) _____ [2]

(b) What was the percentage increase in the number of tickets sold from Thursday to Friday?

Ans : (b) _____ [2]



14. In 2020, the ratio of the number of men to the number of women in Happy Factory was 2 : 1. The ratio of the number of men to the number of women in Cheery Factory was 7 : 13. The total number of people in Happy Factory was 90% of the total number of people in Cheery Factory.

Do not
write
in this
space

(a) What was the ratio of the number of men in Happy Factory to the number of men in Cheery Factory in 2020?

Ans : (a) _____ [2]

(b) In 2021, 8 men left Happy Factory to join Cheery Factory. Then the ratio of the number of men to the number of women in Cheery Factory became 3 : 5. What was the total number of men and women in Cheery Factory in 2020?

Ans : (b) _____ [2]



15. Omar spent \$162 more than $\frac{1}{7}$ of his monthly salary on transport. He spent \$40 less than $\frac{1}{6}$ of his remaining salary on groceries. He spent \$968 on groceries.

He saved the rest of his salary.

- (a) How much of his monthly salary did Omar save?

Ans : (a) _____ [2]

- (b) What was Omar's monthly salary?

Ans : (b) _____ [2]

- (c) Find Omar's total salary in $1\frac{1}{4}$ years.

Ans : (c) _____ [1]

Do not
write
in this
space



16. A rectangular piece of paper was folded at two of its corners F and H as shown.

Do not write in this space

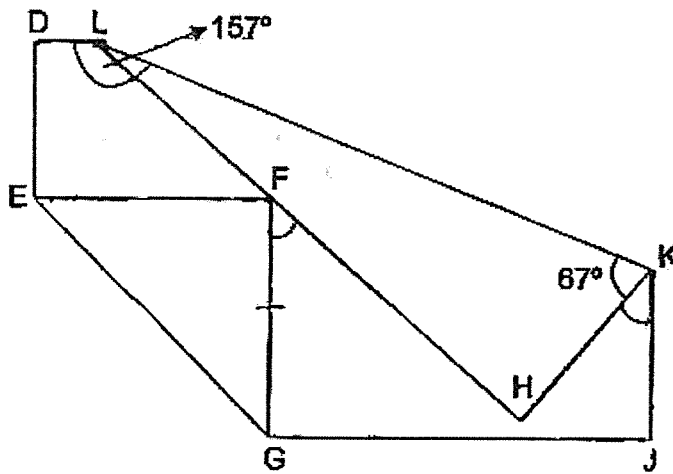

(a) Find $\angle HKJ$.

Ans : (a) _____ [2]

(b) Find $\angle DLF$.

Ans : (b) _____ [1]

(c) Find $\angle GFH$.

Ans : (c) _____ [1]

(d) Circle the words that describe DEFL correctly in the following statement :

DEFL (is / is not) a trapezium because DL (is / is not) parallel to EF.

[1]



17. An empty rectangular tank with a base area of 1250 cm^2 was to be filled with water from 2 taps, X and Y. Tap X filled the tank with water at 2.7 l per minute while tap Y filled it with water at 1.5 l per minute. Tap Z drained water out of the tank at 1.8 l per minute.

Do not write in this space

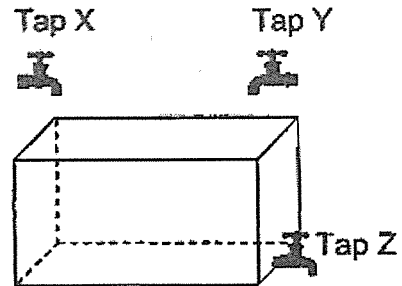

- (a) At 12.41 p.m., all 3 taps were turned on. How much water was there in the tank at 12.47 p.m.? Leave your answer in l and ml.

Ans : (a) _____ [1]

- (b) At 12.47 p.m., only tap X was turned off. At 12.55 p.m., $\frac{1}{3}$ of the tank was filled with water. What is the height of the tank?

Ans : (b) _____ [2]

(Go on to the next page)



— (c) At 12.55 p.m., tap Z was also turned off. After some time, tap Y was turned off. $\frac{3}{4}$ of the tank was filled with water. At what time was tap Y turned off? Leave your answer in the 24-hour clock.

Do not
write
in this
space

Ans : (c) _____ [2]

End of Paper



SCHOOL : CHIJ SCHOOL
LEVEL : PRIMARY 6
SUBJECT : MATHEMATICS
TERM : 2023 PRELIMINARY EXAMINATION

Booklet A

| | | | | | | | | | |
|-----|-----|-----|-----|-----|----|----|----|----|-----|
| Q1 | Q2 | Q3 | Q4 | Q5 | Q6 | Q7 | Q8 | Q9 | Q10 |
| 3 | 3 | 4 | 2 | 1 | 2 | 4 | 3 | 2 | 4 |
| Q11 | Q12 | Q13 | Q14 | Q15 | | | | | |
| 2 | 2 | 1 | 1 | 4 | | | | | |

Booklet B

| | |
|-----|--|
| Q16 | 0.43m |
| Q17 | $2\frac{7}{8}$ |
| Q18 | $15 / 6 = 2.5$ $2.5 \times 100 = 250$ |
| Q19 | $11.4 - 0.5 = 10.9\text{cm}$ |
| Q20 | $118 + 97 = 215$ $276 - 34 - 215 = 27$ $27 = 11 = 16$ $19 - 16 = 3$ |
| Q21 | $28 \times 4 = 112$ $112 - 28 - 22 - 20 = 42$ |
| Q22 | 1 bowl -> \$r 1 pot -> \$14r $7r + 14r = 21r$ \$(21r + 30) |

Q23) $\angle SQP = (180 - 27) \div 2 = 76.5^\circ$
 $\angle RQS = 76.5 - 44 = 32.5^\circ$

Q24)

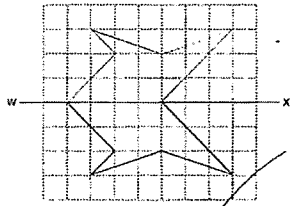

Q25) $4 + 2 = 6$
 $16 + 2 = 18$
Ans : 6 and 18

Q26) $0.4 \times 1000 = 400$ (1 round)
 $400 \times 5 = 2000$
 $2000 \div 10 = 200$ m/min

Q27) a) $\frac{1}{5} \times 60 = 12$ min
b) 1.25 p.m.

Q28) $56 + 40 + 32 + 24 = 152$
 $152 \div 4 = 38$
40 is nearer to 38 and 40 is on Friday

Q29) **False**
Not possible tell
False

Q30) $36 = 6 \times 6$
 $6 + 4 = 10$ cm

PAPER 2

Q1) $69 - 45 = 24$
 $24 \times 2 = 48$

Q2) a) $280 \div 4 = 70$
 $(70 - 20 - 20) \div 2 = 15$ cm

b) $70 \times 70 = 4900$
 $(20 \times 15 \times \frac{1}{2}) \times 4 = 600$
 $4900 - 600 = 4300$ cm²

Q3)

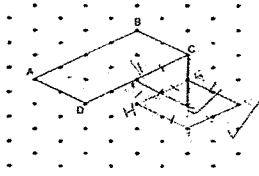

Q4)

$$\begin{aligned}180 \div 3 &= 60 \\ \angle KJQ &= 180 - 138 = 42 \\ \angle JKQ &= 90 - 60 = 30 \\ \angle JQK &= 180 - 42 - 30 = 108 \\ \angle NQL &= \angle JQK = 108 \\ \angle QLP &= 180 - 108 - 60 = 12^\circ\end{aligned}$$

Q5)

$$\begin{aligned}\text{a)} & 125 \div 5 = 25 \\ & (25 \times 7) \times 3 = 525 \\ & 525L = 525000\text{cm}^3 \\ \text{b)} & 125 - 100 = 25 \\ & 25 \div 25 = 1 \\ & 5 - 1 = 4 \\ \text{Ans} & : 6 \text{ p.m.}\end{aligned}$$

Q6)

a) \$29.40
b) Glynis : cap
Levivia : Towel

Q7)

$$\text{a) } 1 - \frac{6}{11} = \frac{5}{11} \text{ (left at the party)}$$

$$132 \times \frac{5}{11} = 60$$

$$\begin{aligned}\text{b)} & 60 - 14 = 46 \\ & 46 + 132 = 178\end{aligned}$$

Q8)

$$\text{a)} (7 - n)$$

$$\begin{aligned}\text{b)} & 13 - 7 = 6 \\ & 6 \div 2 = 3\end{aligned}$$

$$\begin{aligned}\text{c)} & 10 \times 3 = 30 \\ & 7 - 3 = 4 \\ & 4 \times 5 = 20 \\ & 20 + 30 = 50\end{aligned}$$

Q9)

$$\begin{aligned}\text{a)} & (120 \div 2) \times 90 = 5400 \\ \text{b)} & 5 \times 90 = 450 \\ & 450 - 9 = 441 \\ & (120 \div 10) \times 441 = 5292\end{aligned}$$

| | |
|------|--|
| Q10) | 467.82 cm |
| Q11) | a)39° b)129° c)31° |
| Q12) | a) Notebook b) \$93.60 c) \$130 |
| Q13) | a) $80 + 60 + 104 + 51 = 295$ $9440 \div 295 = \$32$ b) $80 + 60 = 140$ $104 + 51 = 155$ $155 - 140 = 15$ $\frac{15}{140} \times 100 = 10\frac{5}{7}\%$ |
| Q14) | a)12: 7 b)200 |
| Q15) | a) $968 + 40 = 1008$ 1 unit = 1008 $(1008) + 40 = \$5080$ b) $(1008 \times 6) + 162 = 6210$ $(6210 \div 6) \times 7 = \7245 c) \$108675 |
| Q16) | a) $\angle HKJ = 180 - 67 - 67 = 46$ $\angle HKJ = 46^\circ$ b) $\angle GFH = 44^\circ$ |
| Q17) | a) $(2.7 + 1.5) - 1.8 = 2.4$ $2.4 \times 6 = 14.4$ $14.4L = 14L 400ml$ b) $1.8 - 1.5 = 0.3$ $14.4L = 14400ml$ $0.3 = 300ml$ $14400 - (300 \times 8) = 12000$ $(12000 \times 3) \div 1250 = 28.8 \text{ cm}$ |