

Index
No.

--	--	--	--	--

—

--

--

PEI CHUN PUBLIC SCHOOL
PRELIMINARY EXAMINATION, 2023

MATHEMATICS
PAPER 1
(BOOKLET A)

Additional materials: Optical Answer Sheet (OAS) Total Time For Booklets A & B : 1 hour

Name : _____ ()

Class : Primary 6 / _____

Math Teacher: _____

Date : 18 August 2023

INSTRUCTIONS TO CANDIDATES

DO NOT OPEN THIS BOOKLET UNTIL YOU ARE TOLD TO DO SO.

FOLLOW ALL INSTRUCTIONS CAREFULLY.

ANSWER ALL THE QUESTIONS.

SHADE YOUR ANSWERS IN THE OPTICAL ANSWER SHEET (OAS) PROVIDED.

YOU ARE NOT ALLOWED TO USE A CALCULATOR.

Questions 1 to 10 carry 1 mark each. Questions 11 to 15 carry 2 marks each.
For each question, four options are given. One of them is the correct answer.
Make your choice (1, 2, 3 or 4). Shade the correct oval (1, 2, 3 or 4) on the
Optical Answer Sheet. (20 marks)

1. $29\,758 = 20\,000 + 9000 + \boxed{} + 50 + 8$

What is the missing number in the box?

- (1) 7
 - (2) 70
 - (3) 700
 - (4) 7000
2. Which of the following has the same value as 6.01 kg?
- (1) 6001 g
 - (2) 6 kg 10 g
 - (3) 6 kg 100 g
 - (4) 60 100 g
3. The figure below is made up of 9 identical squares.
What fraction of the figure is **not** shaded?

- (1) $\frac{5}{9}$
- (2) $\frac{7}{9}$
- (3) $\frac{7}{18}$
- (4) $\frac{11}{18}$

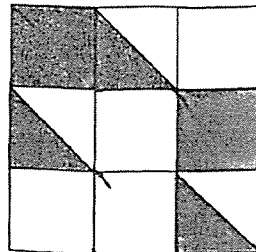

4. Study the square grid below.

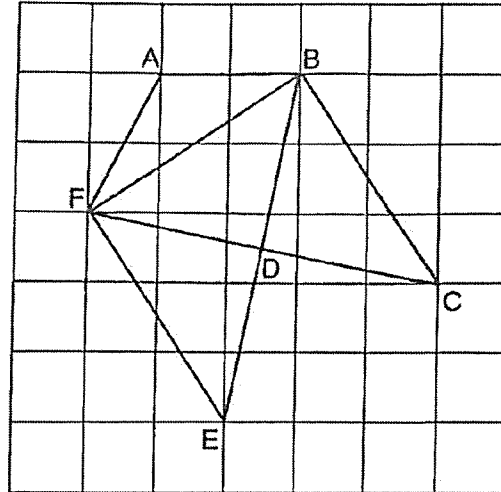

Which line in the square grid is perpendicular to BC?

- (1) BF
- (2) EF
- (3) AB
- (4) BE

The bar graph below shows the number of members in a fitness club from 2018 to 2022. Study the graph and answer questions 5 and 6.

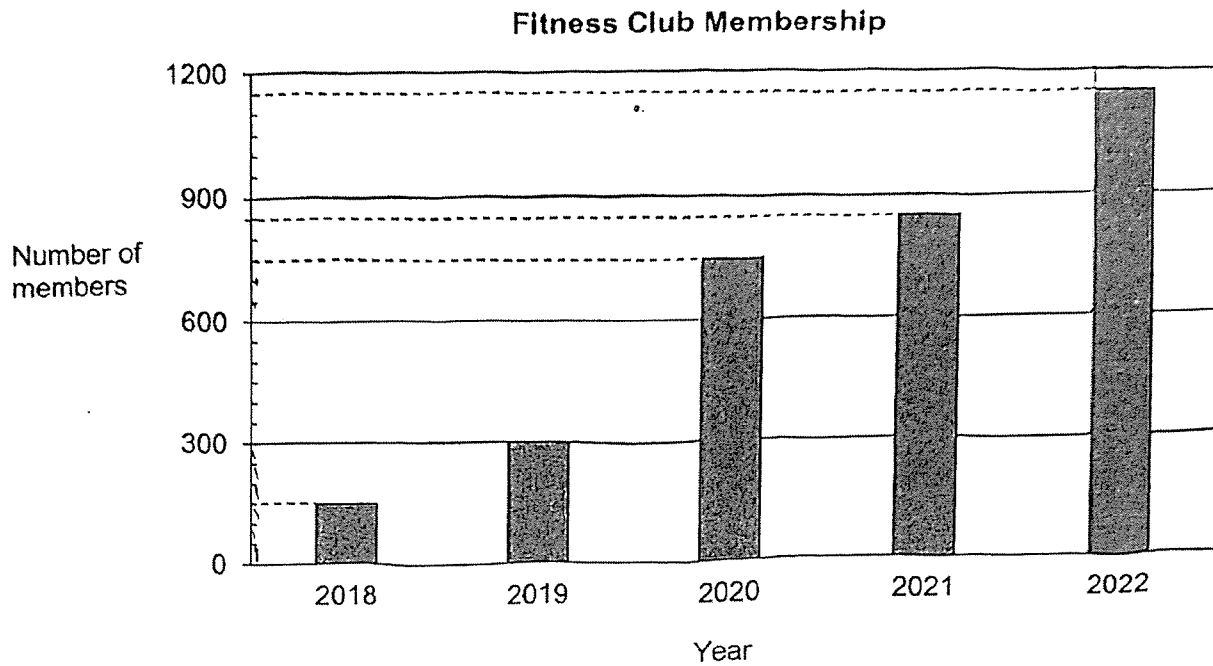

5. How many members were there in 2020?

- (1) 630
- (2) 650
- (3) 700
- (4) 750

6. Between which 2 years was there more than 100% increase in membership?

- (1) 2018 and 2019
- (2) 2019 and 2020
- (3) 2020 and 2021
- (4) 2021 and 2022

7. Express $2\frac{3}{12}$ as a decimal.

- (1) 2.3
- (2) 2.14
- (3) 2.25
- (4) 2.312

8. What is the height of the teacher's table in the classroom?

- (1) 8 cm
- (2) 8 m
- (3) 80 cm
- (4) 80 m

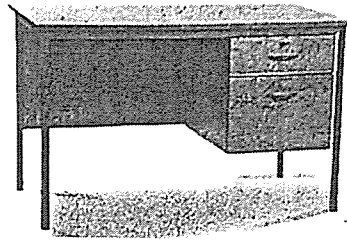

9. Each figure is made up of some identical squares.

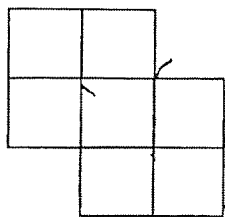

A

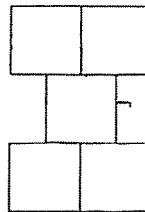

B

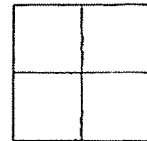

C

Which of the figure(s) has/have exactly 2 lines of symmetry?

- (1) B only
- (2) A and B only
- (3) B and C only
- (4) A, B and C

10. The average of 4 numbers is 34. The sum of the first 3 numbers is 108. What is the fourth number?

- (1) 28
- (2) 2
- (3) 36
- (4) 74

11. This is a net of a solid.

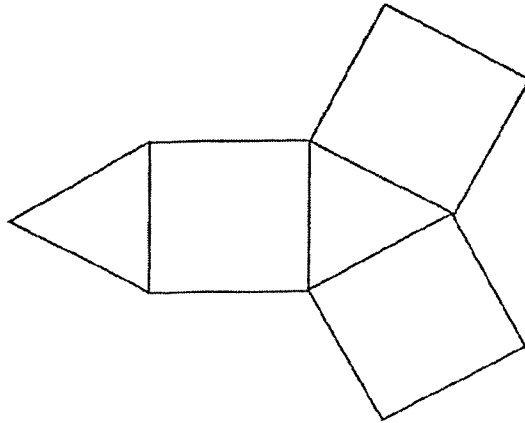

Which of the following solids will this net form?

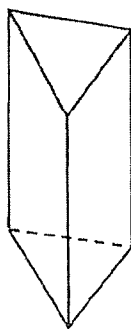

(1)

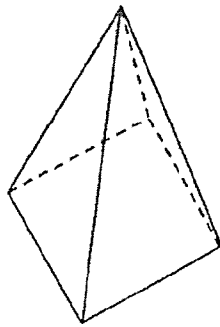

(2)

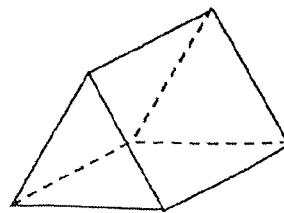

(3)



(4)

12. Arrange the following fractions from the greatest to the smallest.

$$\frac{9}{11}, \frac{6}{7}, \frac{5}{12}$$

greatest

smallest

- | | | | |
|-----|----------------|----------------|----------------|
| | $\frac{5}{12}$ | $\frac{9}{11}$ | $\frac{6}{7}$ |
| (2) | $\frac{9}{11}$ | $\frac{6}{7}$ | $\frac{5}{12}$ |
| (3) | $\frac{9}{11}$ | $\frac{5}{12}$ | $\frac{6}{7}$ |
| (4) | $\frac{6}{7}$ | $\frac{9}{11}$ | $\frac{5}{12}$ |

13. Dave and Ranjit took part in a race. Both boys started running at the same time. After 40 min, Ranjit had completed the race but Dave had another 800 m to complete the race. Ranjit ran at an average speed of 80 m/min. What was Dave's average speed?

- (1) 20 m/min
(2) 60 m/min
(3) 80 m/min
(4) 100 m/min

14. There were some red and green pens in box X and box Y. There were 90 more pens in box Y than box X. The number of red pens in box Y was 30 more than the number of red pens in box X. In box X, there were 25 more green pens than red pens. How many more green pens than red pens were there in box Y?
- (1) 35
- (2) 55
- (3) 75
- (4) 95
15. Jamie and Ian had some marbles. Jamie had 120 fewer marbles than Ian. After Ian gave $\frac{1}{3}$ of his marbles to Jamie, Jamie had 24 more marbles than Ian. How many marbles did Ian have at first?
- (1) 144
- (2) 216
- (3) 264
- (4) 336

Index
No.

--	--	--	--	--	--	--	--

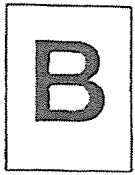

PEI CHUN PUBLIC SCHOOL.
PRELIMINARY EXAMINATION, 2023

MATHEMATICS
PAPER 1
(BOOKLET B)

Total Time For Booklets A & B : 1 hour

Name : _____ ()

Class : Primary 6 / _____

Math Teacher: _____

Date : 18 August 2023

INSTRUCTIONS TO CANDIDATES

DO NOT OPEN THIS BOOKLET UNTIL YOU ARE TOLD TO DO SO.

FOLLOW ALL INSTRUCTIONS CAREFULLY.

ANSWER ALL QUESTIONS.

SHOW YOUR WORKING CLEARLY AS MARKS ARE AWARDED FOR CORRECT WORKING.

WRITE YOUR ANSWERS IN THIS BOOKLET.

USE A DARK BLUE OR BLACK BALLPOINT PEN TO WRITE YOUR ANSWERS IN THE SPACE PROVIDED FOR EACH QUESTION.

DO NOT USE CORRECTION FLUID/TAPE OR HIGHLIGHTERS.

YOU ARE NOT ALLOWED TO USE A CALCULATOR.

Questions 16 to 20 carry 1 mark each. Write your answers in the spaces provided.
For questions which require units, give your answers in the units stated. (5 marks)

16. Express $\frac{3}{7}$ as a decimal. Give your answer correct to 2 decimal places.

Answer: _____

17. Find the value of 408×15 .

Answer: _____

18. PQR is an equilateral triangle. Find $\angle w$.

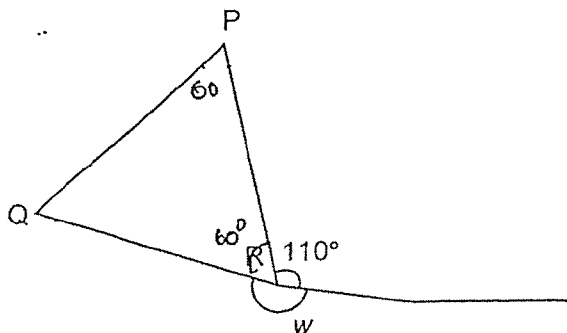

Answer: _____ °

SCORE

19. Find the value of $42.18 + 60$.

Do not write
in this space

Answer: _____

20. Peter started work at 10.30 a.m. and ended work at 6.15 p.m.
How long did he work? Give your answer in hours and minutes.

Answer: _____ h _____ min

SCORE

Questions 21 to 30 carry 2 marks each. Show your working clearly and write your answers in the spaces provided. For questions which require units, give your answers in the units stated. (20 marks)

Do not write
in this space

21. (a) What is the missing number in the box?

$$21 : 18 = \boxed{?} : 12$$

Answer: (a) _____

(b) There are $\frac{4}{5}$ as many male workers as female workers in a factory.
What is the ratio of the number of female workers to the total number of workers in the factory?

Answer: (b) _____

22. (a) Simplify the expression $25 + 9k + 8 - 4k$.

Answer: (a) _____

(b) Find the value of $4y - 7$ when $y = 6$.

Answer: (b) _____

SCORE

23. The usual price of a watch was \$800. During a sale, the watch was selling at \$560. What was the percentage discount given?

Do not write
in this space

Answer: _____ %

24. In the given square grid below,

- (a) draw a trapezium ABCD where AD is twice the length of BC.
Line AB and BC are given.
- (b) draw a triangle ABE where $\angle BAE = 90^\circ$ and $AB = AE$. Line AB is given.

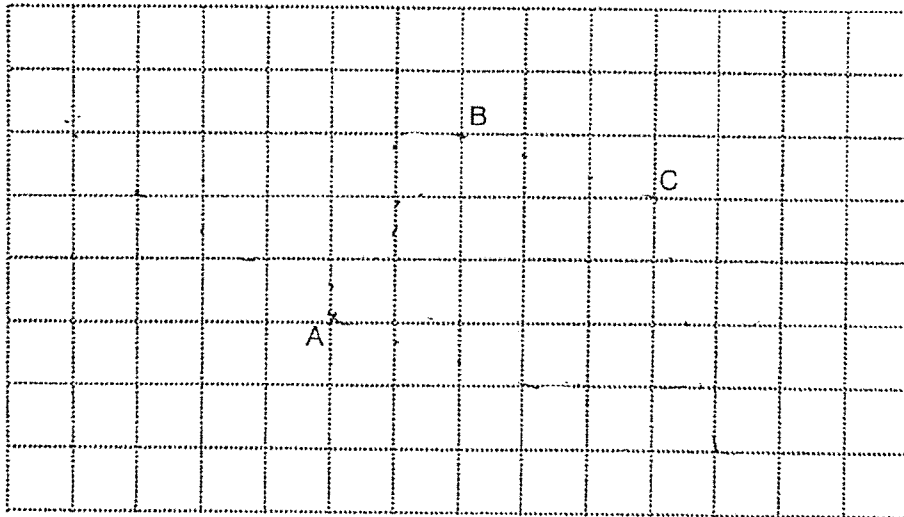

SCORE

25. In the figure below, QRST is a rhombus. QVS is a straight line. $\angle TUV = 46^\circ$ and $\angle RQV = 20^\circ$

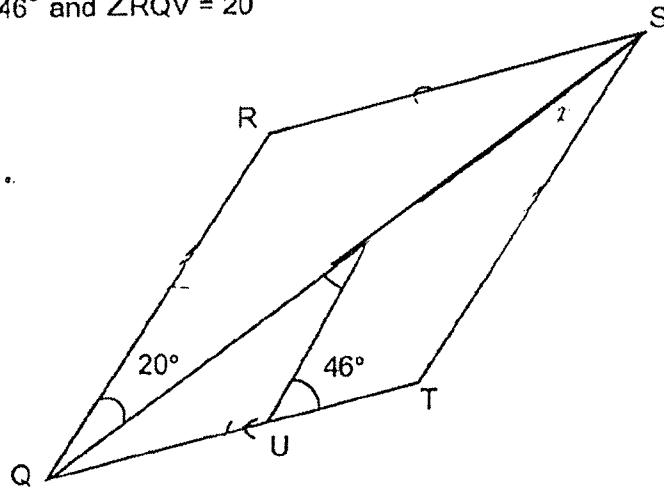

Find $\angle QVU$.

Do not write
in this space

Answer: _____^o

SCORE

26. The table below shows the rates of charges for water consumption in a month.

First 20 m ³	\$1.50 per m ³
Additional amount above 20 m ³	\$2.00 per m ³

Mr Smith used 43 m³ of water. How much did he pay?

Answer: \$ _____

27. $\frac{9}{10}$ m of ribbon is cut into shorter pieces.

Each shorter piece of ribbon measures $\frac{1}{4}$ m except for the last piece.

What is the length of the last piece of ribbon?

Express your answer as a fraction in its simplest form.

Answer: _____ m

SCORE

Do not write
in this space

28. Toni bought 52 cookies and 78 cupcakes for his neighbours. He divided the cookies and cupcakes equally among the neighbours. What was the greatest possible number of neighbours he had?

Answer: _____

29. The figure below is made up of a rectangle WUVY and a square WXYZ. The length of WZ is 8 cm. What is the area of the whole figure?

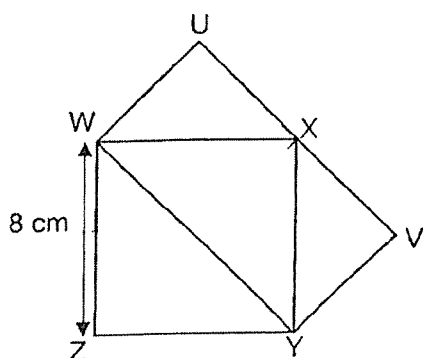

Answer: _____ cm²

SCORE

Do not write in this space

30. The bar graph shows the number of students in the four CCAs, Brownies, Scouts, Volleyball and Basketball. The number of students in the four CCAs is not shown on the scale. The bar graph for the number of students in Brownies CCA has not been drawn. $\frac{2}{5}$ of the students are from Basketball and Volleyball CCAs.

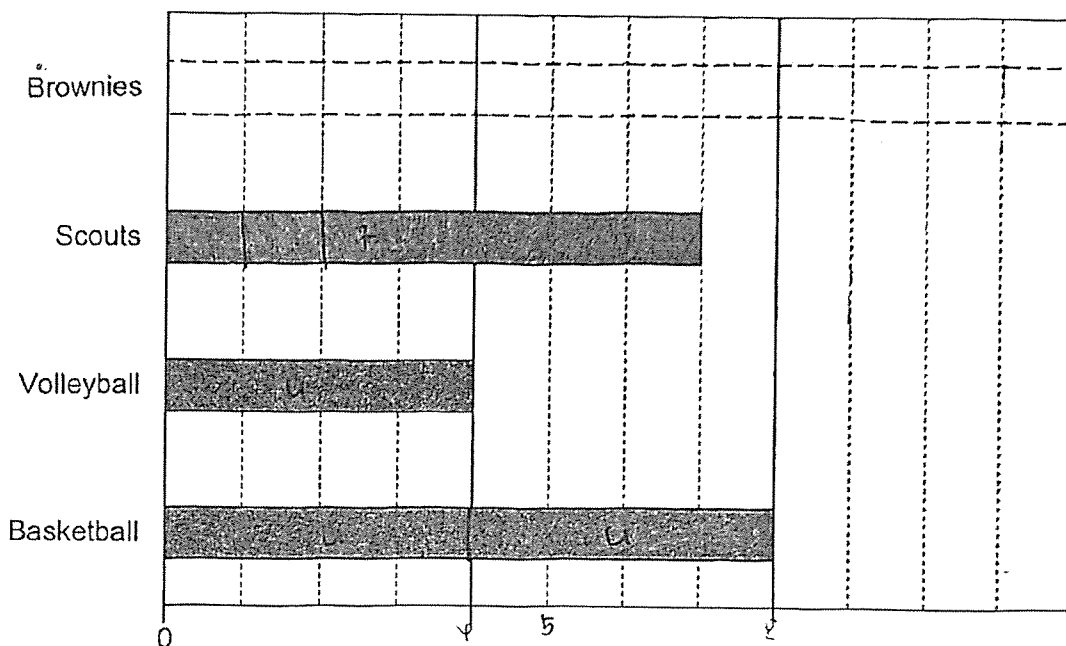

Each statement below is either true, false or not possible to tell from the information given. For each statement, put a (✓) in the correct column.

Statement	True	False	Not possible to tell
There are 40 more students in basketball CCA than in volleyball CCA.			
The number of students in scouts and volleyball CCAs is equal to the number of students in brownies CCA.			

End of Paper

SCORE

Index No. -

PEI CHUN PUBLIC SCHOOL
PRELIMINARY EXAMINATION, 2023
MATHEMATICS
PAPER 2

Time: 1 h 30 min

Name : _____ ()

Class : Primary 6 / _____

Math Teacher: _____

Date : 18 August 2023

Parent's Signature: _____

Paper 1 (Booklet A)	20
Paper 1 (Booklet B)	25
Paper 2	55
TOTAL	100

INSTRUCTIONS TO CANDIDATES

DO NOT OPEN THIS BOOKLET UNTIL YOU ARE TOLD TO DO SO.

FOLLOW ALL INSTRUCTIONS CAREFULLY.

ANSWER ALL QUESTIONS.

SHOW YOUR WORKING CLEARLY AS MARKS ARE AWARDED FOR CORRECT WORKING.

WRITE YOUR ANSWERS IN THIS BOOKLET.

USE A DARK BLUE OR BLACK BALLPOINT PEN TO WRITE YOUR ANSWERS IN THE SPACE PROVIDED FOR EACH QUESTION.

DO NOT USE CORRECTION FLUID/TAPE OR HIGHLIGHTERS.

THE USE OF AN APPROVED CALCULATOR IS ALLOWED.

Questions 1 to 5 carry 2 marks each. Show your working clearly and write your answers in the spaces provided. For questions which require units, give your answers in the units stated. (10 marks)

1. Jim's savings for 5 months were shown in the table below.

Month	January	February	March	April	May
Savings (\$)	35	28	0	51	33

What was the average amount of money Jim saved from January to May?

Answer: \$ _____

2. In the figure below, EH is a straight line. FH = HG = 12 cm. EF = 20 cm and EH = 16 cm. Find the area of the triangle EFG.

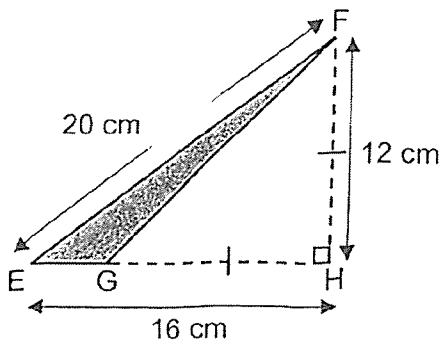

Answer: _____ cm²

SCORE

Do not write
in this space

3. Nancy left her house at 6.55 a.m. to the school, which was 1235 m away. She walked at an average speed of 95 m/min. At what time did she reach the school? Leave your answer in 24-hour clock.

Do not write
in this space

Answer : _____

4. The figure below is made up of two identical squares, ABCD and GJKH, and 2 identical rectangles, EFDA and BCHG. The perimeter of EBCF is 56 cm and the perimeter of AJKD is 72 cm.

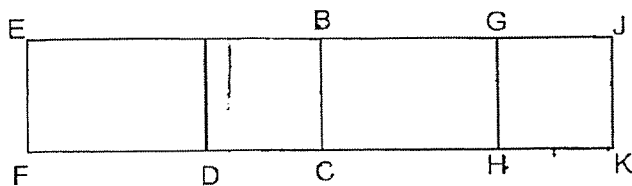

What is the area of square ABCD?

Answer: _____ cm²

SCORE

5. (a) Fang Min glued eight 1-cm cubes to form the solid below. She painted the whole solid, including the base. What was the total painted area?

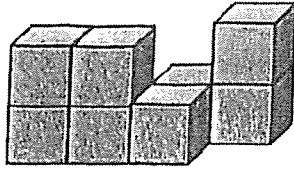

Answer: (a) _____ cm^2

- (b) Bala is asked to build a solid figure using some unit cubes. The front, side and top views of the solid figure to be built are shown below.

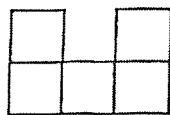

Front view

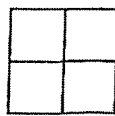

Side view

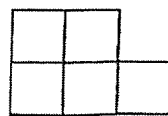

Top view

What is the least number of unit cubes Bala needs to build the solid figure?

Answer: (b) _____

SCORE

For questions 6 to 17, show your working clearly and write your answers in the spaces provided. The number of marks available is shown in brackets [] at the end of each question or part-question. (45 marks)

Do not write in this space

6. The figure is made up of triangle ADG and triangle JKL. $AG \parallel JK$ and $AD = DG$.

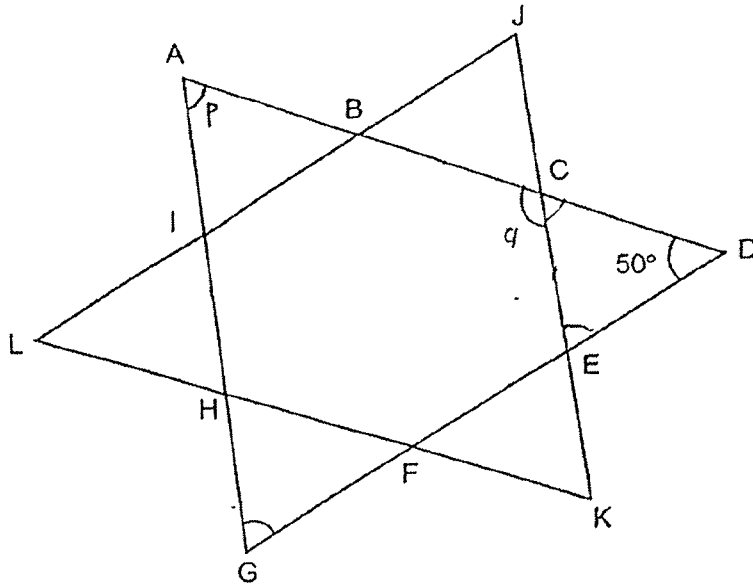

(a) Find $\angle p$.

Answer : (a) _____ [1]

(b) Find $\angle q$.

Answer : (b) _____ [2]

SCORE

7. A rectangular tank contained some water at first. A tap was then turned on to fill the tank completely with water. The tap was turned off at the end of 48 minutes. The graph below shows the amount of water in the tank at the end of 48 minutes.

Do not write
in this space

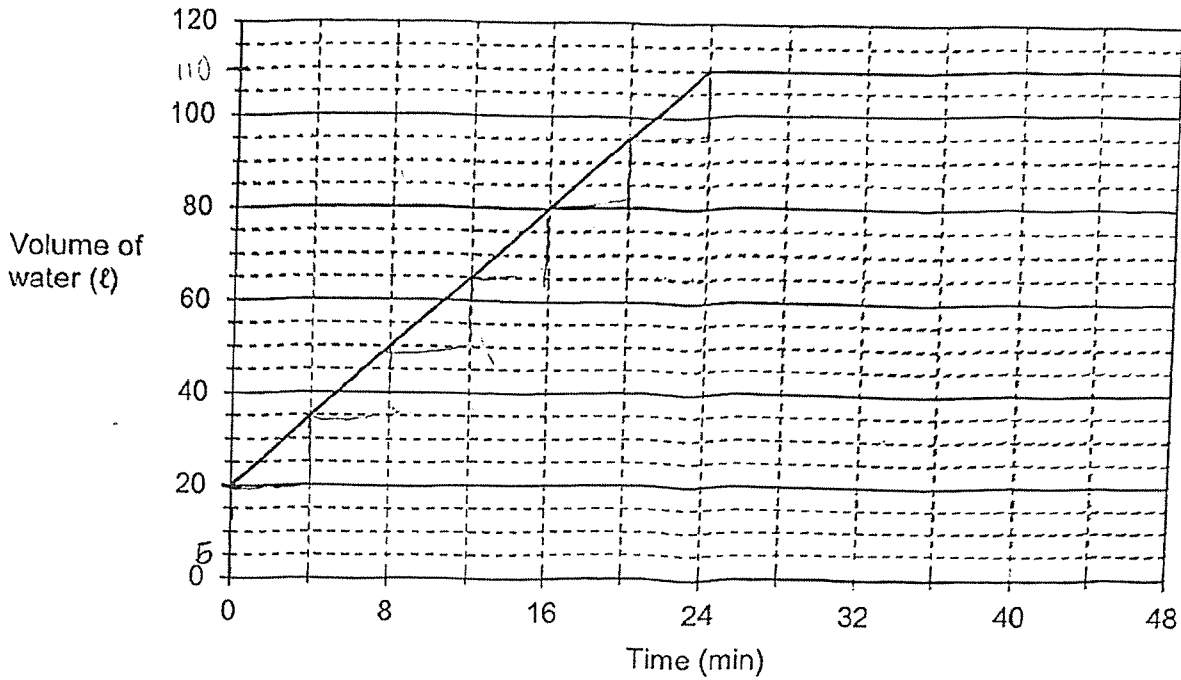

- (a) In a minute, how many litres of water flowed from the tap?

Answer: (a) _____ [1]

- (b) How many litres of water overflowed from the tank at the end of 48 minutes?

Answer: (b) _____ [2]

SCORE

8. The figure is made up of 2 identical triangles and 2 identical squares. The perimeter of the figure is $(4q + 36)$ cm. The perimeter of a square is 36 cm.

Do not write
in this space

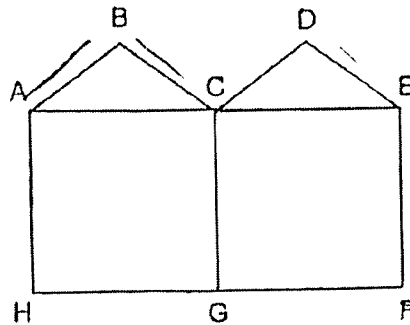

- (a) Find the perimeter of a triangle ABC in terms of q .

Answer : (a) _____ [2]

- (b) The perimeter of the figure is 48 cm. What is the value of q ?

Answer : (b) _____ [1]

SCORE

9. (a) The figures below are drawn on a square grid.

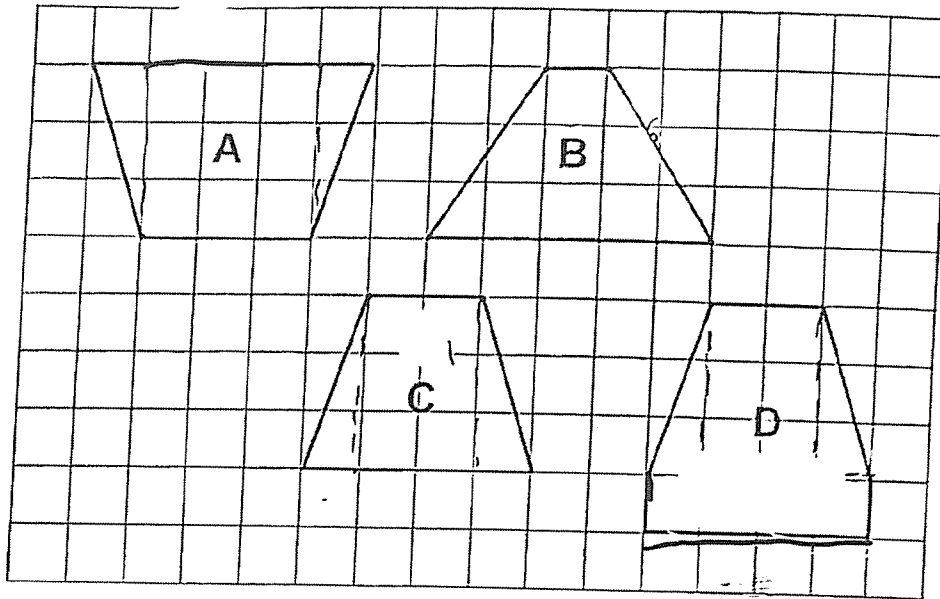

Do not write
in this space

- (i) Which 2 figures have the same area?

Answer : (i) Figure ____ and Figure ____ [1]

- (ii) Which 2 figures have the same perimeter?

Answer : (ii) Figure ____ and Figure ____ [1]

SCORE

9. (b) In the figure, a rectangular piece of paper $WXYZ$ is folded at two of its corners X and Y as shown.

Do not write
in this space

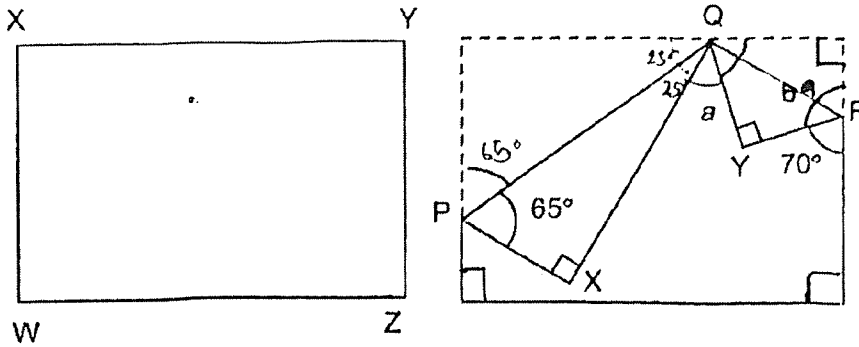

Find $\angle a$.

Answer : (b) _____ [2]

SCORE

10. In the pie chart, half of the fruits in the supermarket are mangoes. The number of pears is $\frac{1}{3}$ the number of mangoes.

Do not write
in this space

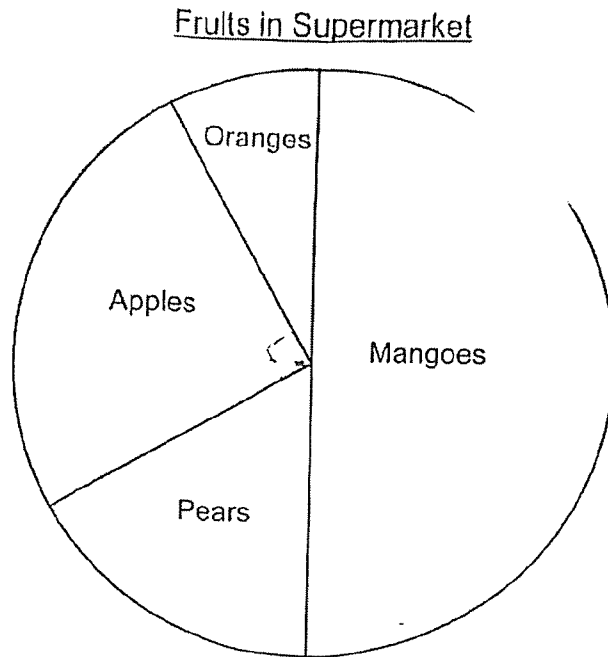

- (a) There are 72 more mangoes than pears. How many mangoes are there?

Answer: (a) _____ [2]

- (b) What fraction of the fruits in the supermarket are oranges?
Express your answer in the simplest form.

Answer: (b) _____ [2]

SCORE

11. In the figure below, ABCD is a rectangle. The points E and F lie on the rectangle ABCD. $\angle DFE = 105^\circ$, $\angle EAC = 32^\circ$ and $\angle BCE = 50^\circ$

Do not write
in this space

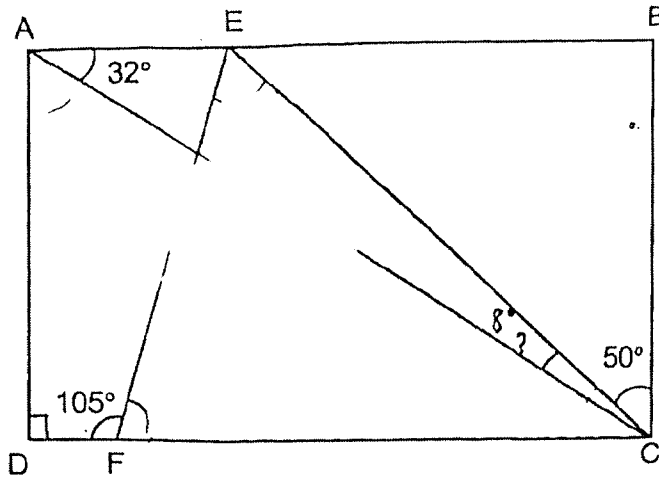

- (a) Find $\angle ECA$.

Answer : (a) _____ [2]

- (b) Find $\angle FEC$.

Answer : (b) _____ [2]

SCORE

12. The figure below is made up of 2 identical big semi-circles and 3 identical small semi-circles.

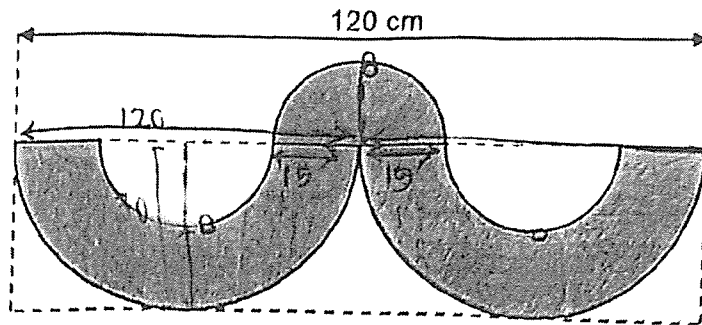

Do not write
in this space

- (a) Find the perimeter of the shaded figure.
(Take $\pi = 3.14$)

Answer: (a) _____ [3]

- (b) Find the total area of the shaded parts.
(Take $\pi = 3.14$)

Answer: (b) _____ [2]

SCORE

13. Mrs Su baked some cheese muffins and raspberry muffins. She sold $\frac{3}{7}$ of the cheese muffins and $\frac{2}{5}$ of the raspberry muffins. $\frac{8}{11}$ of the muffins left were cheese muffins. Mrs Su sold a total of 760 muffins.

(a) What fraction of the muffins were sold?

Answer: (a) _____ [1]

(b) How many muffins did Mrs Su bake?

Answer: (b) _____ [3]

Do not write
in this space

SCORE

14. Mrs Yong had some red apples and green apples. 60% of the apples were red apples and the rest were green apples. There were 192 more red apples than green apples. After Mrs Yong sold some red apples, the percentage of red apples she had left became 25%. How many red apples did Mrs Yong sell?

Do not write
in this space

Answer: _____ [4]

SCORE

15. At first, Tank A was completely filled with water and Tank B was $\frac{1}{5}$ filled with water.

Do not write in this space

Fred turned on both taps X and Y at the same time. Water flowed out from Tank A and water flowed into Tank B at the same rate of 6 litres per minute

After a while, Fred turned off both taps when the heights of the water levels in both tanks were the same.

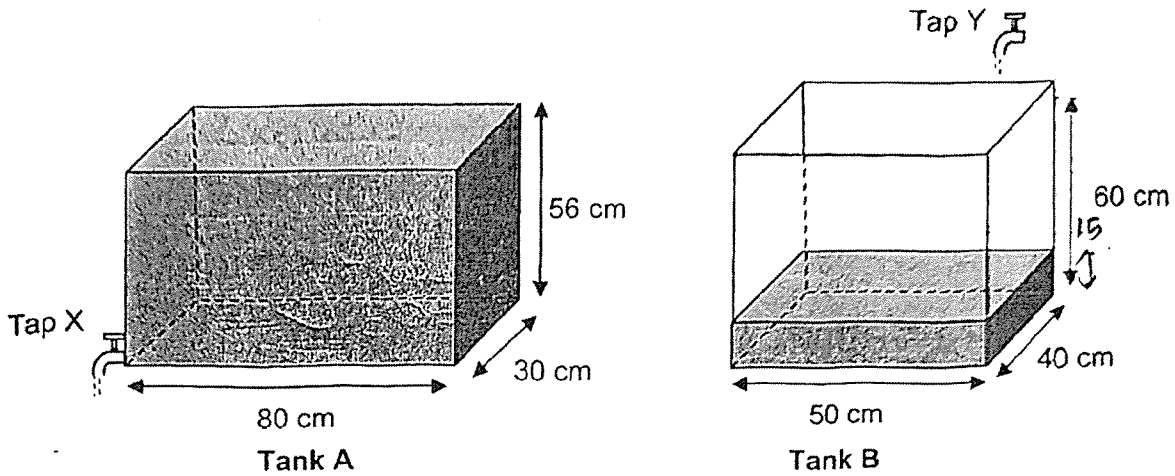

What was the height of the water level in Tank A in the end?

Answer: _____ [4]

SCORE

16. The figure below is made up of a rectangle and a square. The ratio of the area of the rectangle to the area of the square is $11 : 8$. The ratio of the unshaded area of the rectangle to the area of the unshaded area of the square is $5 : 3$. The length of the square is 12 cm .

Do not write
in this space

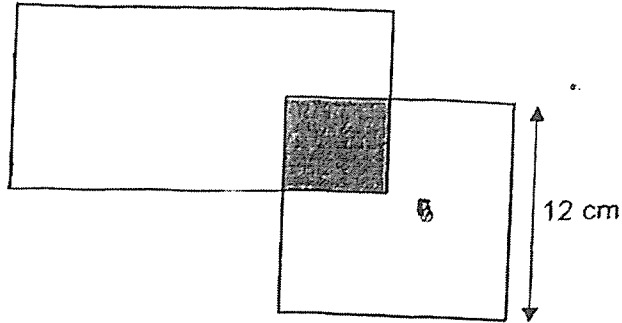

What is the area of the shaded part?

Answer: _____ [3]

SCORE

17. Janelle used grey and white squares to make figures below that follow a pattern. The first 6 figures are shown.

Do not write in this space

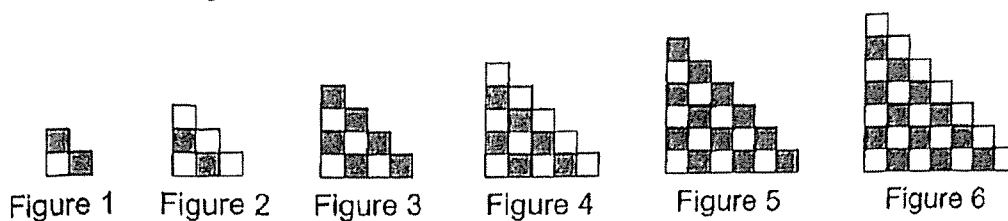

She recorded the number of grey and white squares.

Figure	Number of white squares	Number of grey squares	Total number of squares
1	1	2	3
2	4	2	6
3	4	6	
4	9	6	
5	9	12	
6	16	12	

- (a) What was the total number of squares in Figure 15?

Answer: (a) _____ [2]

- (b) How many grey squares were there in Figure 52?

Answer: (b) _____ [2]

End of Paper

SCORE

SCHOOL : PEI CHUN PRIMARY SCHOOL
LEVEL : PRIMARY 6
SUBJECT : MATHEMATICS
TERM : 2023 PRELIMINARY EXAMINATION

Paper 1

Q1	Q2	Q3	Q4	Q5	Q6	Q7	Q8	Q9	Q10
3	2	4	1	4	1	3	3	2	1
Q11	Q12	Q13	Q14	Q15	Q16	Q17	Q18	Q19	Q20
3	4	2	2	2	0.43	6120	190	0.703	7h45min
Q21	Q22	Q23	Q24	Q25	Q26	Q27	Q28	Q29	Q30
14 5:9	5k+33 17	30%		26°	\$76	3/20km	26	96cm ²	Not possible to tell, True

Paper 2

1	\$29.40
2	24cm ²
3	0708
4	64cm ²
5	a) 32cm ² b) 7
6	a) 65° b) 115°
7	a) 3.75L b) 90L
8	a) (9+2q) cm b) 3
9	ai) Figure B and Figure C ii) Figure A and Figure D b) 60°
10	a) 108 b) 1/12
11	a) 8° b) 65°
12	a) 359.7cm b) 2472.75cm ²
13	a) 1/19 b) 1805
14	448
15	36cm
16	63cm ²
17	a) 136 b) 702

