

HENRY PARK PRIMARY SCHOOL
2023 END OF YEAR EXAMINATION
MATHEMATICS
PRIMARY 5

PAPER 1
(BOOKLET A)

Name: _____ ()

Parent's Signature

Class: Primary 5 _____ / 5M _____

Marks:

Paper 1	Booklet A	20
	Booklet B	25
Paper 2		55
Total		100

Total Time for Booklets A and B: 1 hour

Do not turn over this page until you are told to do so.

Follow all instructions carefully.

Answer all questions.

Shade your answers in the Optical Answer Sheet (OAS) provided.

You are **not** allowed to use a calculator.

Questions 1 to 10 carry 1 mark each. Questions 11 to 20 carry 2 marks each.
For each question, four options are given. One of them is the correct answer.
Make your choice (1, 2, 3 or 4) and shade your answer in the Optical Answer Sheet.

(30 marks)

1. $80\,000 + 5000 + 700 + 2 = \underline{\hspace{2cm}}$

(1) 85 720

(2) 85 702

(3) 85 072

(4) 80 572

2. Find the value of $50 - (5 + 21) + 2 \times 3$

(1) 11

(2) 36

(3) 49

(4) 99

3. What fraction of the hearts in the box are shaded?

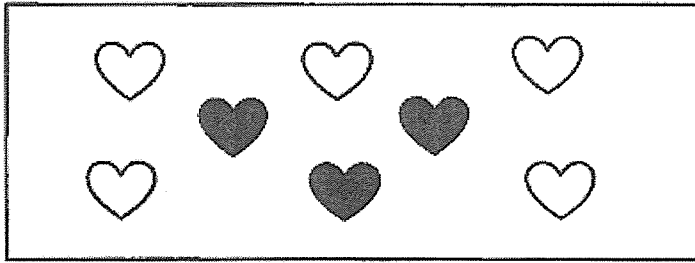

- (1) $\frac{3}{8}$
- (2) $\frac{5}{8}$
- (3) $\frac{1}{2}$
- (4) $\frac{3}{5}$
4. Which decimal is greater than 0.08 but smaller than 0.15?
- (1) 0.1
- (2) 0.9
- (3) 0.01
- (4) 0.23
5. Keith had 400 marbles. 120 of his marbles were green. What percentage of Keith's marbles were green?
- (1) 70%
- (2) 60%
- (3) 40%
- (4) 30%

6. There are 70 buttons in a box. 24 of the buttons are red while the rest are blue. Express the number of red buttons to the number of blue buttons as a ratio in the simplest form.

- (1) 12 : 23
- (2) 12 : 35
- (3) 23 : 12
- (4) 23 : 35

7. Johan folds 5 paper cranes in 8 minutes. At this rate, how many paper cranes can Johan fold in 40 minutes?

- (1) 25
- (2) 64
- (3) 200
- (4) 320

8. A solid cuboid of height 8 cm has a square base of side 10 cm. What is its volume?

- (1) 28 cm³
- (2) 80 cm³
- (3) 640 cm³
- (4) 800 cm³

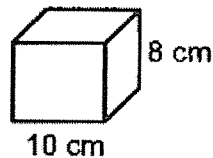

9. In the figure, KLMN is a rectangle. Find $\angle a$.

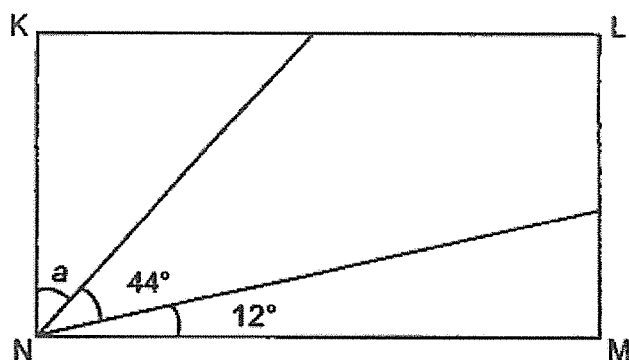

- (1) 34°
- (2) 45°
- (3) 46°
- (4) 56°

10. The graph below shows the number of printers sold by a shop from January to April.

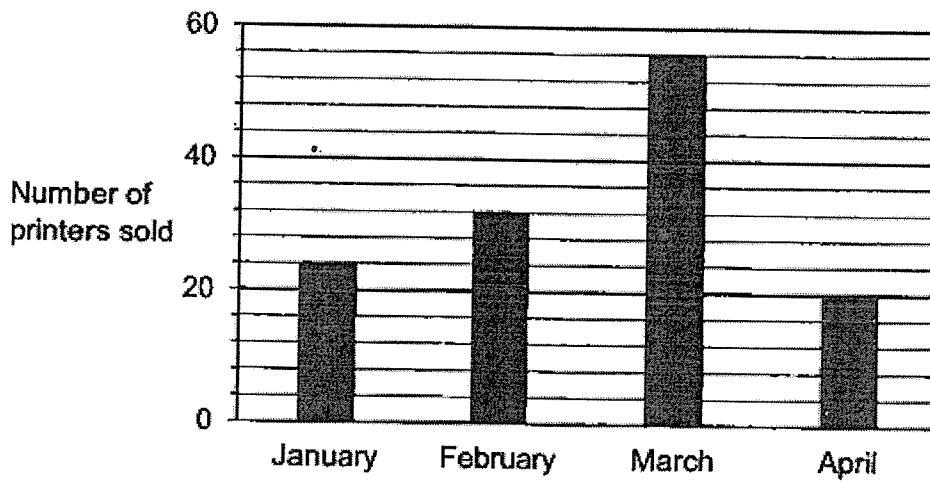

How many printers did the shop sell in February?

- (1) 23
 - (2) 26
 - (3) 30
 - (4) 32
11. The solid below is made up of some identical 1-cm cubes.

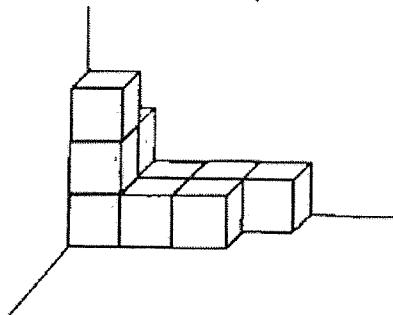

What is the volume of the solid?

- (1) 9 cm^3
- (2) 10 cm^3
- (3) 17 cm^3
- (4) 18 cm^3

12. PQRS is parallelogram and PQT is an isosceles triangle. Find $\angle TQR$.

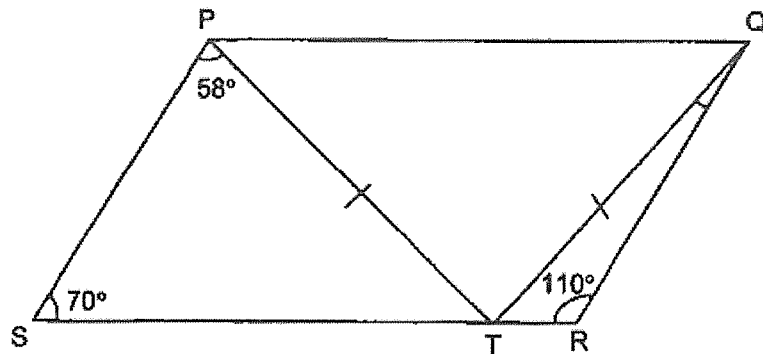

- (1) 6°
(2) 8°
(3) 12°
(4) 18°
13. The ratio of the length of a rectangle to its breadth is 6 : 5. The perimeter of the rectangle is 88 cm. What is the area of the rectangle?
- (1) 120 cm^2
(2) 240 cm^2
(3) 480 cm^2
(4) 4320 cm^2

14. The figure below is made up of 2 squares of sides 5 cm and 3 cm. Find the shaded area.

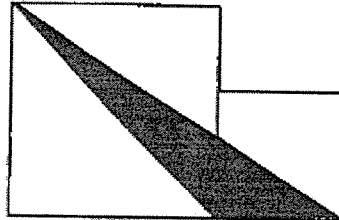

- (1) 7.5 cm^2
 (2) 12.5 cm^2
 (3) 15 cm^2
 (4) 20 cm^2
15. A table with 4 columns is filled with odd numbers in a certain pattern. The first 4 rows of the table are shown below.

	Column A	Column B	Column C	Column D
Row 1	1	3	5	7
Row 2	9	11	13	15
Row 3	17	19	21	23
Row 4	25	27	29	31
⋮	⋮	⋮	⋮	⋮

In which column will the number 159 appear?

- (1) Column A
 (2) Column B
 (3) Column C
 (4) Column D



HENRY PARK PRIMARY SCHOOL
2023 END OF YEAR EXAMINATION
MATHEMATICS
PRIMARY 5

PAPER 1
(BOOKLET B)

Name: _____ ()

Class: Primary 5 _____ / 5M _____

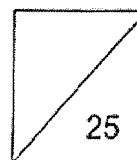

Total Time for Booklets A and B: 1 hour

Do not turn over this page until you are told to do so.

Follow all instructions carefully.

Answer all questions.

Write your answers in this booklet.

You are not allowed to use a calculator.

Questions 16 to 20 carry 1 mark each. Write your answers in the spaces provided.
For questions which require units, give your answers in the units stated.

(5 marks)

16. Find the greatest multiple of 8 that is less than 50.

Ans: _____

17. Find the value of $\frac{1}{3} \times \frac{5}{7}$.

Ans: _____

18. Find the value of $7.2 \div 3$

Ans: _____

19. What is the missing number in the box?

$$63 : \boxed{?} = 7 : 2$$

Do not write
in this space

Ans: _____

20. Printer A prints 20 posters in 1 minute. Printer B prints 30 posters in 1 minute. Given that printers A and B start printing at the same time, how long does it take for both printers to finish printing 4000 posters altogether?

Ans: _____ min

Questions 21 to 30 carry 2 marks each. Show your working clearly and write your answers in the spaces provided. For questions which require units, give your answers in the units stated.

(20 marks)

21. Gwen baked some cupcakes. After Amy took $\frac{1}{7}$ of the cupcakes and May took $\frac{2}{3}$ of the cupcakes, there were 24 cupcakes left. How many cupcakes did Gwen bake?

Ans: _____

22. Mr Lim had a total of 880 chairs in his shop. He sold 45% of the chairs. How many chairs did Mr Lim sell?

Ans: _____

23. The figure shows a right-angled triangle. Find the area of the triangle.

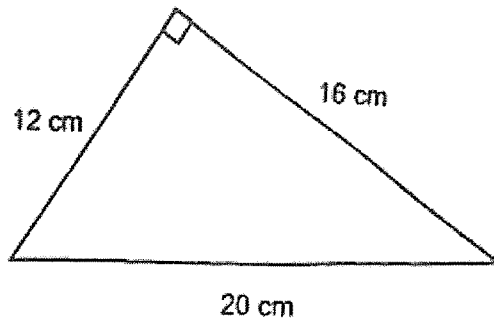

Do not write
in this space

Ans: _____ cm²

24. A group of 4 boys had an average of 32 stickers. When Edward joined the group, the 5 boys had an average of 42 stickers. How many stickers did Edward have?

Ans: _____

25. In the diagram below, ABC and DBE are straight lines. Find $\angle p$.

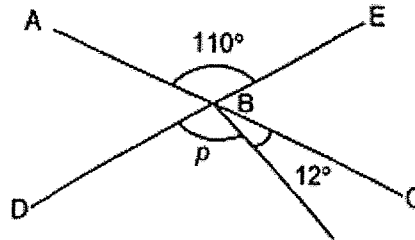

Ans: _____^o

26. In the figure below, ABCD is a rhombus and ADE is an isosceles triangle. EDC is a straight line and $AE = AD$. Find $\angle CAE$.

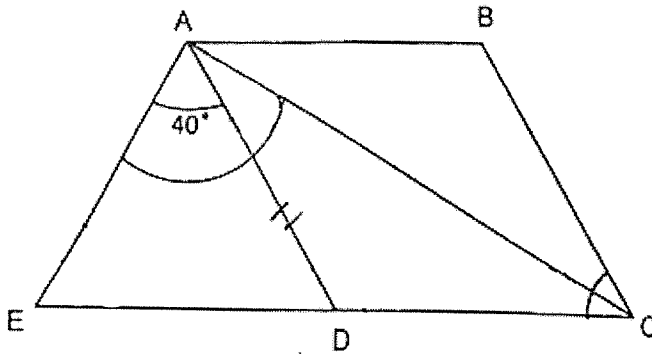

Ans: _____^o

27. The average test score of a group of students was 80. When Miss Lim recorded the test score of these students, she wrongly recorded one student's test score as 20 when it should have been 90. As a result, Miss Lim calculated the average test score as 78. How many students were there in the group?

Do not write
in this space

Ans: _____

28. Kelly and Louis had the same number of cookies at first. Each day, Kelly ate 4 cookies while Louis ate 6 cookies. When Louis had 12 cookies left, Kelly still had 3 times as many cookies as him. How many cookies did Kelly have at first?

Ans: _____

29. ABCD is a parallelogram. EFC is a straight line.
 $\angle DAB = 120^\circ$, $\angle BEC = 66^\circ$ and $\angle DFC = 78^\circ$, find $\angle CBD$.

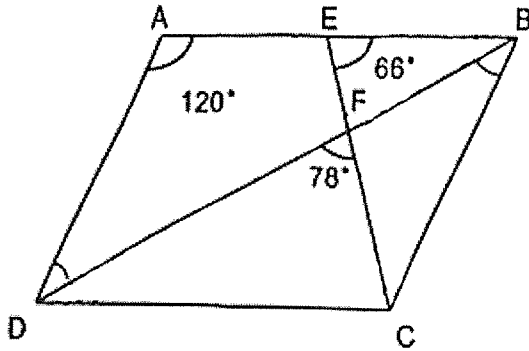

Ans: _____°

30. Figure 1 shows a square piece of paper, WXYZ. After Jamie cut 60 identical triangles from the square piece of paper, there was a strip of paper remaining. Figure 2 shows the measurement of one such triangle Jamie cut. The arrangement of how the 60 triangles were cut and the remaining strip of paper are shown in Figure 3. Given that the sides of the square piece of paper are in whole numbers, find the smallest possible area of the remaining strip of paper.

Do not write
in this space

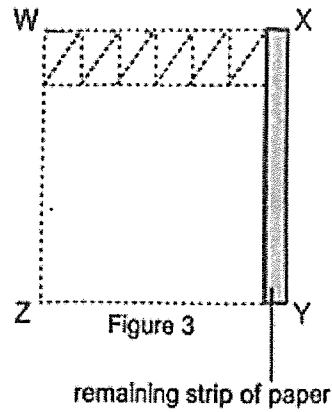
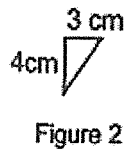
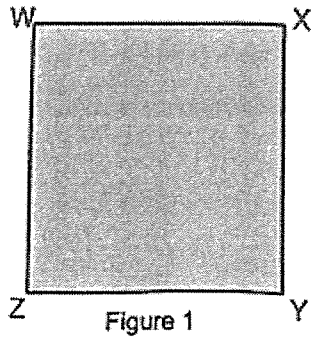

Ans: _____ cm²

— End of Paper 1 —

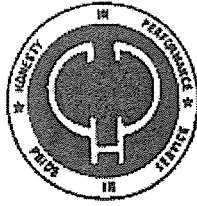

HENRY PARK PRIMARY SCHOOL
2023 END OF YEAR EXAMINATION
MATHEMATICS
PRIMARY 5

PAPER 2

Name: _____ ()

Class: Primary 5 _____ / 5M _____

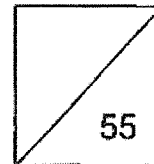

Time for Paper 2: 1 h 30 min

Do not turn over this page until you are told to do so.

Follow all instructions carefully.

Answer all questions.

Show your working clearly as marks are awarded for correct working.

Write your answers in this booklet.

You are allowed to use a calculator.

3. The shaded area of the figure below is 50 cm^2 . Find the area of the unshaded part.

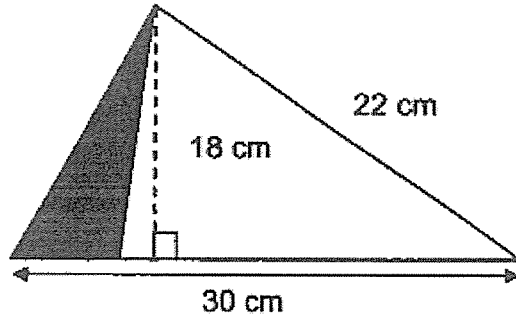

Ans: _____ cm^2

4. In the figure below, a rectangular piece of paper is folded along DE as shown. Find $\angle p$.

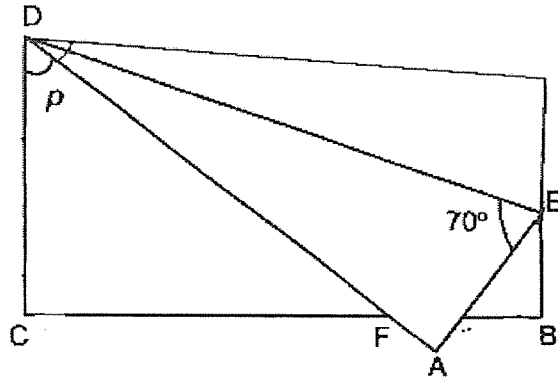

Ans: _____ $^\circ$

Please do not write in the margin.

Please do not write in the margin.

Please do not write in the margin.

Go on to the next page

7. Ahmad baked some chocolate and strawberry cupcakes in the ratio of 2 : 7. He sold $\frac{1}{2}$ of the strawberry cupcakes in the morning. After that, he had 285 more strawberry cupcakes than chocolate cupcakes left. How many cupcakes did Ahmad bake in total?

Please do not write in the margin.

Please do not write in the margin.

Ans: _____ [3]

Please do not write in the margin.

Go on to the next page

- 8. Ms Loh boarded a taxi at the airport and headed to a hotel 16 km 300 m away. Her taxi fare was based on the charges shown below.

Distance travelled	Charge
First kilometre or less	\$4.20
Every 400 m thereafter or less	\$0.27
Airport surcharge	\$3.50

How much was her taxi fare?

Please do not write in the margin.

Please do not write in the margin.

Ans: _____ [3]

Please do not write in the margin.

Go on to the next page

9. In the figure below, ABCD and DEFG are two parallelograms. AGB is a straight line. $\angle DEF = 50^\circ$, $\angle DAG = 75^\circ$ and $\angle CDE = 156^\circ$. Find $\angle ADG$.

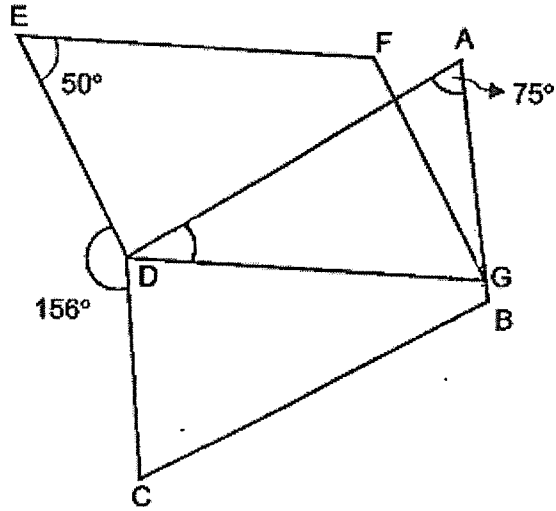

Please do not write in the margin.

Please do not write in the margin.

Ans: _____ [3]

Please do not write in the margin.

Go on to the next page

10. The graph below shows the sale for concert tickets for 6 days.
Use the graph to answer the following questions:

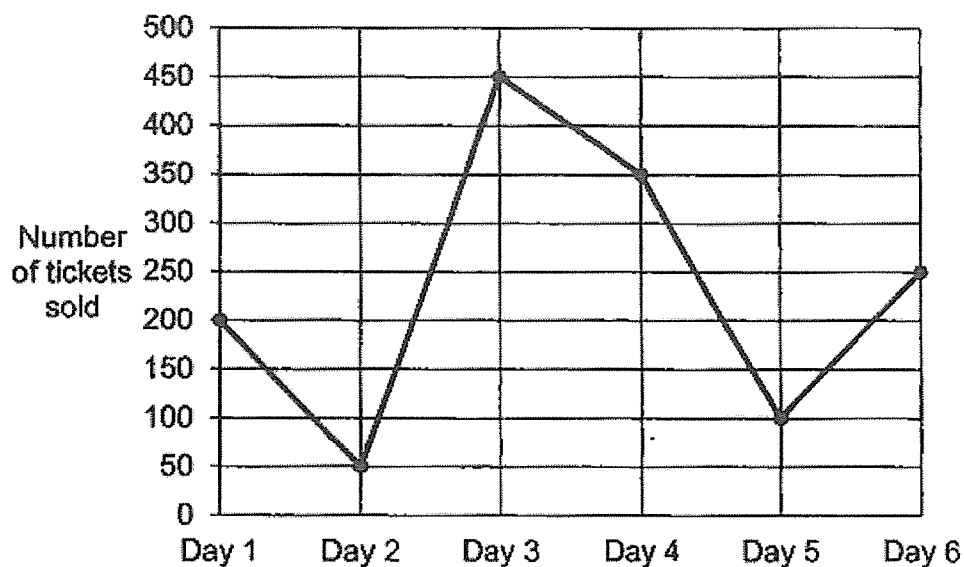

- (a) On which day was there a decrease in sales by 100 tickets compared to the day before?

Ans: (a) Day _____ [1]

Please do not write in the margin.

Go on to the next page

- (b) $\frac{7}{10}$ of the total number of tickets sold from Day 4 to Day 6 were child tickets. The rest were adult tickets. The prices of adult and child tickets are shown below.

Ticket	Price per ticket
Adult	\$45
Child	\$20

How much money was collected from the sales of ticket from Day 4 to Day 6?

Please do not write in the margin.

Please do not write in the margin.

Ans: (b) _____ [3]

Please do not write in the margin.

Go on to the next page

13. Mr Tan sold chairs at a furniture sale event. For every chair sold, he would earn \$3. For every 25 chairs sold, he would earn an additional \$10. Given that Mr Tan earned \$364 from selling the chairs, how many chairs did he sell?

Please do not write in the margin.

Please do not write in the margin.

Ans: _____ [4]

Please do not write in the margin.

Go on to the next page

14. A container measuring 25 cm by 16 cm by 48 cm was $\frac{1}{3}$ -filled with water at first. 500 ml of water was then used for watering the plants.

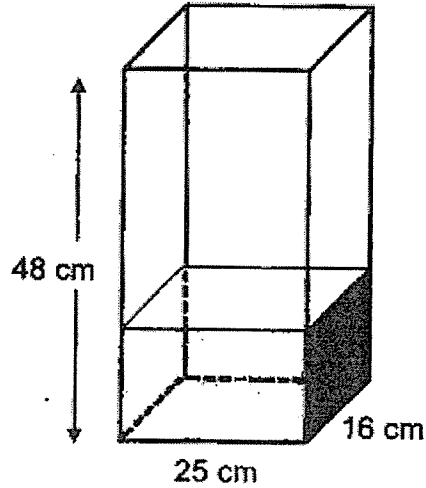

- (a) How many litres of water were left in the container?

Ans: (a) _____ [2]

- (b) Eric poured all the remaining water in the container into identical bottles. Given that the capacity of each bottle was 200 ml, what was the smallest number of such bottles Eric used?

Ans: (b) _____ [2]

Please do not write in the margin.

Go on to the next page

Please do not write in the margin.

Please do not write in the margin.

15. A box contains some coloured ribbons. 44% of the ribbons are yellow and the rest are pink and blue. The ratio of the number of pink ribbons to the number of blue ribbons is 3 : 5. There are 1748 more yellow ribbons than pink ribbons. How many ribbons are there altogether?

Please do not write in the margin.

Please do not write in the margin.

Ans: _____ [3]

Please do not write in the margin.

Go on to the next page

SCHOOL : HENRY PARK PRIMARY SCHOOL
LEVEL : PRIMARY 5
SUBJECT : MATHEMATICS
TERM : 2023 END OF YEAR EXAM

Booklet A

Q1	Q2	Q3	Q4	Q5	Q6	Q7	Q8	Q9	Q10
2	1	1	1	4	1	1	4	1	4
Q11	Q12	Q13	Q14	Q15					
2	4	3	1	4					

Booklet B

Q16	48
Q17	$\frac{5}{21}$
Q18	2.4
Q19	18
Q20	80 min
Q21	$1 - \frac{1}{7} - \frac{2}{3} = \frac{4}{21}$ $4u = 24$ $1u = 6$ $21u = 21 \times 6 = 126$
Q22	$\frac{45}{100} \times 880 = 396$
Q23	$0.5 \times 12 \times 16 = 96\text{cm}^2$
Q24	$(5 \times 42) - (4 \times 32) = 82$
Q25	$110 - 12 = 98^\circ$
Q26	$ADE = (180 - 40) \div 2 = 70^\circ$ $CAD = 70 \div 2 = 35^\circ$ $CAE = 40 + 35 = 75^\circ$
Q27	$90 - 20 = 70$ $80 - 78 = 2$ $70 \div 2 = 35$

Q28	<p>Common multiples of 4 and 6 = 12, 24, 36, 48, 60, 72, 84 No. of cookies Kelly had left = $3 \times 12 = 36$ Use guess and check method, taking common multiples as Kelly and Louis' cookies at first Guess 1: Cookies both had first = 84 Days taken for Kelly to be left with 36 cookies = $(84 - 36) \div 4 = 12$ days Days taken for Louis to be left with 12 cookies = $(84 - 12) \div 6 = 12$ days Ans: 84</p>
Q29	<p>$\angle EBF = 180^\circ - 66^\circ - 78^\circ = 36^\circ$ $\angle BDC = 36^\circ$ $\angle CBD = 180^\circ - 36^\circ - 120^\circ = 24^\circ$</p>
Q30	<p>1 row = 12 triangles $60 \div 12 = 5$ rows $5 \times 4 = 20$ cm \rightarrow length of 1 side of square $20 - 18 = 2$ cm $20 \times 2 = 40$ cm²</p>

PAPER 2

Q1	<p>$58.3 \text{ g} \times 40 = 2332 \text{ g}$ $2332 \text{ g} + 356 \text{ g} = \mathbf{2688 \text{ g}}$</p>
Q2	<p>$\\$4200 \times 1.025 = \mathbf{\\$4305}$</p>
Q3	<p>Area of big triangle = $0.5 \times 18 \times 30 = 270 \text{ cm}^2$ Area of unshaded part = $270 - 50 = \mathbf{220 \text{ cm}^2}$</p>
Q4	<p>$\angle ADL = 180^\circ - (90^\circ + 70^\circ) = 20^\circ$ $\angle p = 90^\circ - 20^\circ - 20^\circ = \mathbf{50^\circ}$</p>
Q5	<p>$G + H + F + H = \\$730 + \\$638 = \\$1368$ $2H = \\$1368 - \\$952 = \\$416$ $1H = \\$416 \div 2 = \mathbf{\\$208}$</p>
Q6	<p>$8B - 145 = T$ $3B + 210 = T$ $8B - 145 = 3B + 210$ $5B = 355$ $1B = 71$ No. of beads = $(3 \times 71) + 210 = \mathbf{423}$</p>
Q7	<p>$0.5 \times 7 = 3.5u$ $3.5u - 2u = 285$ $1.5u = 285$ $1u = 190$ $9u = 9 \times 190 = \mathbf{1710}$</p>
Q8	<p>$16 \text{ km } 300 \text{ m} = 16300 \text{ m}$ $(16300 - 1000) \div 400 = 38 \text{ R } 100$ $\\$3.50 + \\$4.20 + \\$0.27 \times (38 + 1) = \mathbf{\\$18.23}$</p>

Q9	$\angle EDA = 360^\circ - 156^\circ - (180^\circ - 75^\circ) = 99^\circ$ $\angle ADG = 180^\circ - 50^\circ - 99^\circ = 31^\circ$
Q10a	Day 4
Q10b	Total sales from Day 4 to 6 = $350 + 100 + 250 = 700$ Amt. collected from adult ticket sales = $\frac{3}{10} \times 700 \times \$45 = \$9450$ Amt. collected from child ticket sales = $\frac{7}{10} \times 700 \times \$20 = \$9800$ Total money collected = $\$9450 + \$9800 = \mathbf{\$19250}$
Q11a	$\$4560 \div 6 = \760 $(\$760 \times 5) - \$760 = \$3040$ 5p = \$3040 1p = \$608 $\$760 - \$608 = \mathbf{\$152}$
Q11b	$\$3040 \div 2 = \mathbf{\$1520}$
Q12a	$\frac{2}{3} \times \frac{5}{6} = \frac{5}{9}$
Q12b	No. of bowls bought = 8 No. of plates bought = 12 $12 \times \$10 = \120 $\frac{120}{(360 \times 9)} = \frac{1}{27}$
Q13	Total earned from selling 25 chairs = $25 \times \$3 + \$10 = \$85$ $\$364 \div \$85 = 4 \text{ R } \$24$ $\$24 \div \$3 = 8$ $8 + (25 \times 4) = \mathbf{108}$
Q14a	Vol. of water at first = $\frac{1}{3} \times 48 \times 25 \times 16 = 6400 \text{ ml}$ Vol. of water left = $6400 - 500 = 5900 \text{ ml} = \mathbf{5.9 \ell}$
Q14b	$5900 \div 200 = 29 \text{ R } 100$ $29 + 1 = \mathbf{30}$
Q15	P : B : Total 3 : 5 : 8 = 21 : 35 : 56 $44u - 21u = 1748$ $23u = 1748$ $1u = 76$ $100u = \mathbf{7600}$

Q16	1 mango = 1u 1 durian = 3u Total units for 17 durians and 14 mangoes = $51u + 14u = 65u$ $65u = 5p$ $1p = 13u$ $13u - (3 \times 3u) = 4u \rightarrow 4$ mangoes bought with half of remaining money Total mangoes bought = $4 + 14 = \mathbf{18}$
Q17a	Cost of small keychain = $\$14.80 \div 4 = \3.70 Group 1 small and 1 large keychain = $\$14.80 + \$3.70 = \$18.50$ $\$629 \div \$18.50 = \mathbf{34}$
Q17b	$18 \times \$3.70 = \66.60 $\$529.10 - \$66.60 = \$462.50$ $\$462.50 \div \$18.50 = 25$ $25 + 18 = \mathbf{43}$