



**ST. HILDA'S PRIMARY SCHOOL**  
**END-OF-YEAR EXAMINATION 2023**

**Booklet A**

# **PRIMARY 4 MATHEMATICS**

**Total Time for Booklets A and B: 1 hour 45 minutes**

**Additional Materials: Optical Answer Sheet**

**Booklet A: 20 Multiple-Choice Questions (40 marks)**

## **INSTRUCTIONS TO CANDIDATES**

1. Do not turn over this page until you are told to do so.
2. Follow all instructions carefully.
3. Answer all the questions.
4. Shade your answers in the Optical Answer Sheet provided.
5. The use of calculators is **NOT** allowed.

**Name** : \_\_\_\_\_

**Index No.:** \_\_\_\_\_ **Class :** P4 / \_\_\_\_\_ **Date :** 23 October 2023

**Parent's Signature** : \_\_\_\_\_

This booklet consists of 8 printed pages and 1 blank page.



Questions 1 to 20 carry 2 marks each. For each question, four options are given. One of them is the correct answer. Make your choice (1, 2, 3 or 4). Shade the correct oval (1, 2, 3 or 4) on the Optical Answer Sheet. (40 marks)

1. In which of the following numbers does the digit 7 stand for 70?

- (1) 3407
- (2) 4073
- (3) 4730
- (4) 7304

2. Which of the following is a factor of both 12 and 40?

- (1) 12
- (2) 8
- (3) 6
- (4) 4

3. Which one of the following has  $\frac{1}{3}$  of the figure shaded?

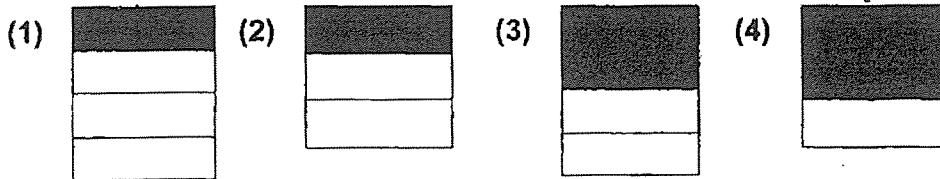

4.  $6\frac{7}{8} = \frac{\square}{8}$

What is the missing number in the box?

- (1) 42
- (2) 48
- (3) 50
- (4) 55

5. In the figure below, what is the length of the pencil in cm?

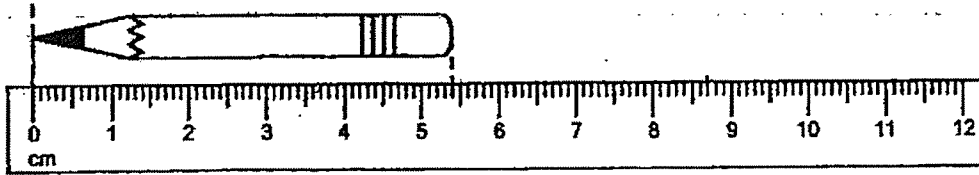

- (1) 6.6 cm  
(2) 6.4 cm  
(3) 5.9 cm  
(4) 5.4 cm
6. What is the number when 11.84 is rounded to 1 decimal place?
- (1) 11.0  
(2) 11.8  
(3) 11.9  
(4) 12.0
7. Which of the following letters is symmetrical?

(1) **N**

(2) **S**

(3) **X**

(4) **Z**

8. Andy had 578 marbles at first. After giving 142 marbles to Shirley, he had twice the number of marbles as Shirley in the end. How many marbles did Shirley have at first?
- (1) 76
  - (2) 146
  - (3) 218
  - (4) 240
9. Which of the following numbers is both a factor of 16 and a multiple of 4?
- (1) 1
  - (2) 2
  - (3) 6
  - (4) 4
10. Chuan Rui is thinking of a number. When it is divided by 18, it has a quotient of 324. What is the number?
- (1) 18
  - (2) 306
  - (3) 342
  - (4) 5832
11. A fruit seller had 5630 oranges. He packed all the oranges into boxes of 8. How many oranges were left unpacked?
- (1) 703
  - (2) 6
  - (3) 3
  - (4) 30

12. Tim ate  $\frac{4}{9}$  of a cake.

Mark ate  $\frac{1}{2}$  of the same cake.

What fraction of the cake was left?

(1)  $\frac{1}{18}$

(2)  $\frac{3}{7}$

(3)  $\frac{5}{11}$

(4)  $\frac{5}{18}$

13. Amirah saved an equal amount of money each month.

She saved \$19.20 in 2 months.

How much would she save in 7 months?

(1) \$44.80

(2) \$67.20

(3) \$134.40

(4) \$268.80

14. Harvey has 4 times as much money as Chris.

Harvey has \$147 more than Chris.

How much money does Chris have?

(1) \$36.75

(2) \$49

(3) \$441

(4) \$588

15. The figure below is made up of 3 identical squares and 2 identical rectangles. The breadth of the rectangle is half the length of a square. What is the length of the unknown side?

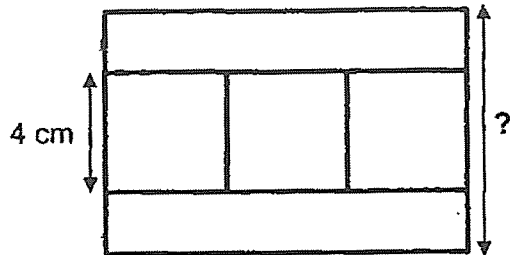

- (1) 12 cm  
 (2) 2 cm  
 (3) 6 cm  
 (4) 8 cm
16. The figure below shows a rectangular piece of paper with 2 identical squares cut out from it. What is the area of the remaining figure?

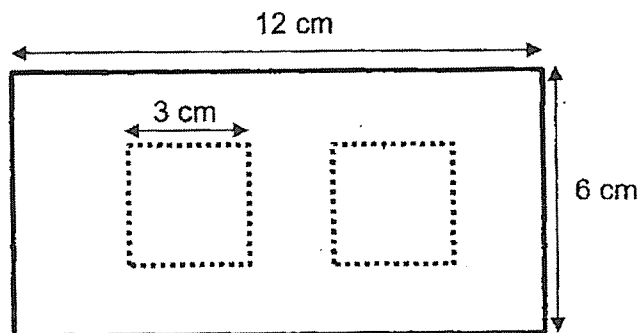

- (1)  $72 \text{ cm}^2$   
 (2)  $63 \text{ cm}^2$   
 (3)  $54 \text{ cm}^2$   
 (4)  $18 \text{ cm}^2$

17. Jean is standing at point A facing the Museum.  
She makes a \_\_\_\_\_° turn in the clockwise direction to face the Library.

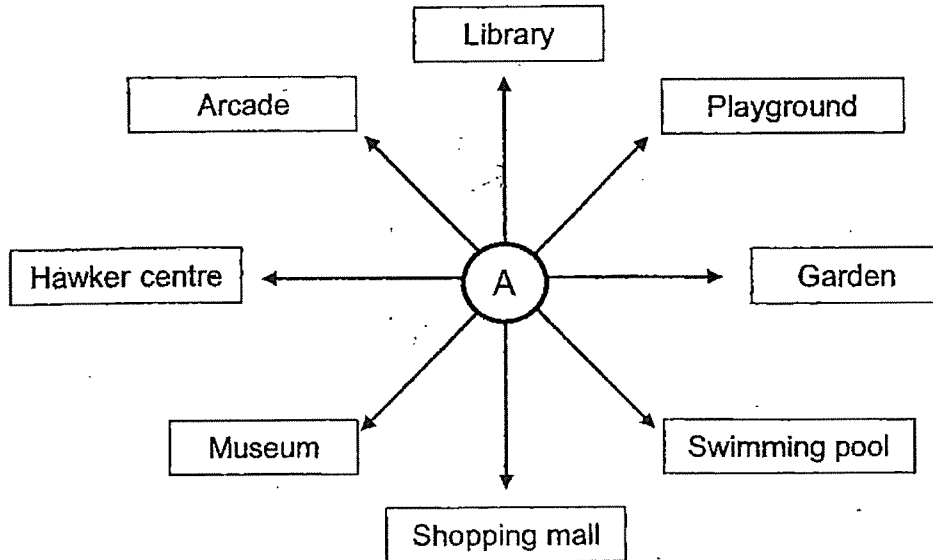

- (1) 90  
(2) 135  
(3) 225  
(4) 270

18. The diagram below shows the seating positions of some students in a class.

Enya	Anna	Chris
Vijay	En Rui	Aiman
Hidaya	Ratna	Rajesh

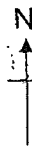

Who is sitting north-east of En Rui?

- (1) Aiman  
(2) Enya  
(3) Chris  
(4) Hidaya

Study the bar graph below carefully.

The bar graph below shows the number of cups of ice cream Alice sold last week at Sweetness Café.

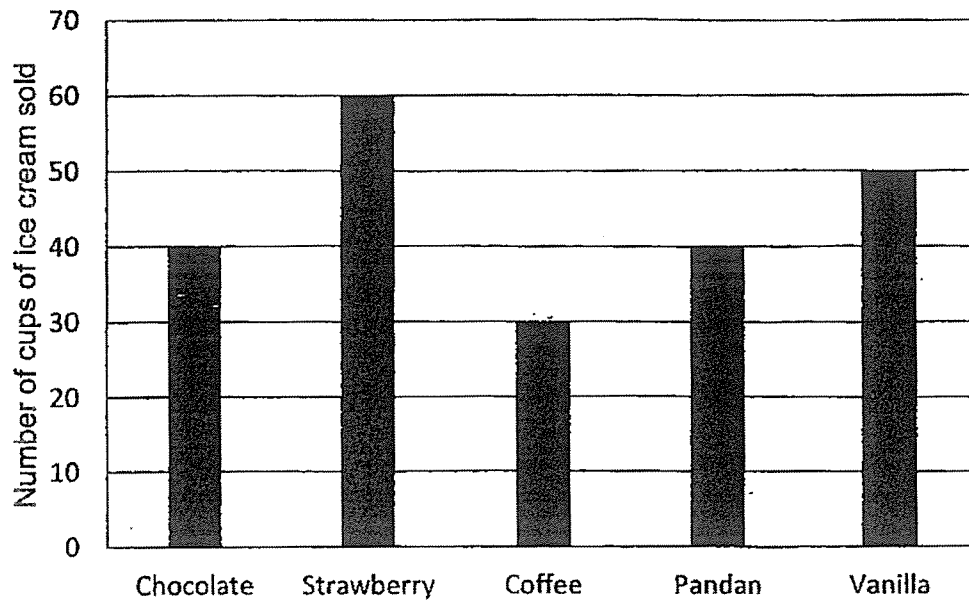

19. What was the total number of cups of chocolate and vanilla ice cream sold at Sweetness Café?
- (1) 10
  - (2) 80
  - (3) 90
  - (4) 100
20. Alice sold twice as many cups of \_\_\_\_\_ ice cream as compared to coffee ice cream.
- (1) chocolate
  - (2) strawberry
  - (3) pandan
  - (4) vanilla

END OF BOOKLET A  
Proceed to Booklet B



ST. HILDA'S PRIMARY SCHOOL

Booklet B

END-OF-YEAR EXAMINATION 2023

# PRIMARY 4 MATHEMATICS

Total Time for Booklets A and B: 1 hour 45 minutes

Booklet B: 20 Short Answer Questions (40 marks)  
5 Long Answer Questions (20 marks)

## INSTRUCTIONS TO CANDIDATES

1. Do not turn over this page until you are told to do so.
2. Follow all instructions carefully.
3. Answer all the questions.
4. Write your answers in this booklet.
5. The use of calculators is **NOT** allowed.

Name : _____	
Index No.: _____ Class: P4 / _____ Date : <u>23 October 2023</u>	
Booklet A	/ 40
Booklet B	/ 60
Total	/ 100
Parent's Signature : _____	

This booklet consists of 15 printed pages and 1 blank page.

Questions 21 to 40 carry 2 marks each. Show your working clearly in the space provided for each question and write your answers in the spaces provided. For questions which require units, give your answers in the units stated. (40 marks)

Do not write  
in this space

21. Write twenty-seven thousand and seventy in figures.

Ans: \_\_\_\_\_

22. What is the missing number in the number pattern below?

6849 , 7099 , 7349 , \_\_\_\_\_ , 7849

Ans: \_\_\_\_\_

23.  $\frac{2}{3} - \frac{1}{12} =$  \_\_\_\_\_

Ans: \_\_\_\_\_

24. What is the value of  $\frac{1}{3} + \frac{5}{6}$  ?

Express your answer as a mixed number.

Ans: \_\_\_\_\_

25. Find the value of  $1 - \frac{1}{2} - \frac{1}{6}$ .

Express your answer in the simplest form.

Ans: \_\_\_\_\_

Do not write  
in this space

26. Write the decimal represented by A.

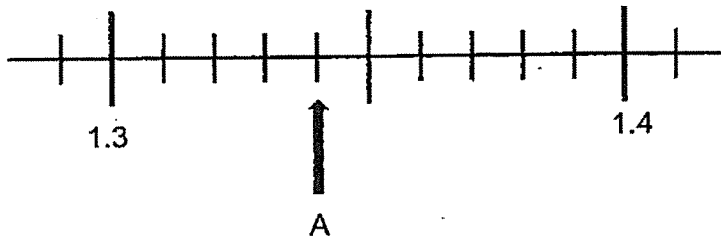

Ans: \_\_\_\_\_

27. Arrange the following decimals in order from the smallest to the greatest.

1.08 , 0.018 , 0.081

\_\_\_\_\_ , \_\_\_\_\_ , \_\_\_\_\_  
(smallest) (greatest)

28. Measure and write down the size of angle  $x$ .

Do not write  
in this space

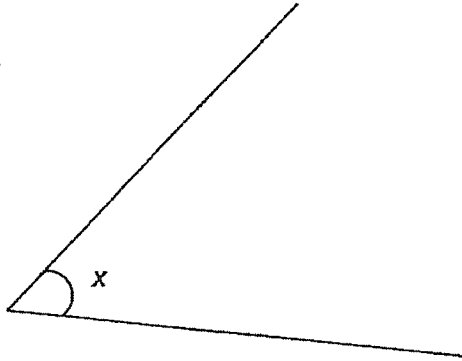

Ans:  $\angle x =$  \_\_\_\_\_<sup>o</sup>

29. In the figure, ABCD is a rectangle. Find the value of  $\angle y$ .

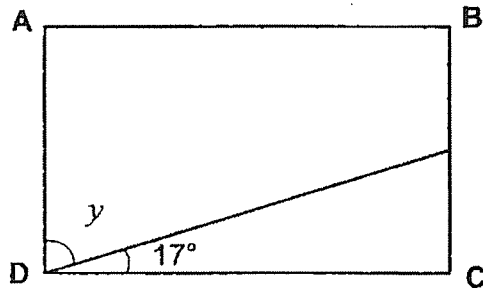

Ans:  $\angle y =$  \_\_\_\_\_<sup>o</sup>

30. Find the value of  $27 \div 8$ , correct to 2 decimal places.

Do not write  
in this space

Ans: \_\_\_\_\_

31. The table shows the amounts of money Jamie earned from January to April. Jamie earned a total of \$3795 in the 4 months.  
What was Jamie's amount earned in February?

Month	Amount Earned
January	\$ 640
February	?
March	\$ 802
April	\$ 945

Ans: \$ \_\_\_\_\_

32. At a fruit shop, apples and oranges were packed into bags for sales. There were 587 bags of fruits. Each bag contains 12 apples and 6 oranges. How many apples and oranges were there altogether?

Ans: \_\_\_\_\_

- 
33. Martha had \$36. She had 5 times as much money as Rina. How much money did both of them have?

Ans: \$ \_\_\_\_\_

Do not write  
in this space

34. The figure shown is made up of 3 identical rectangles and 4 identical squares. The length of a square is 9 cm. Find the area of the figure.

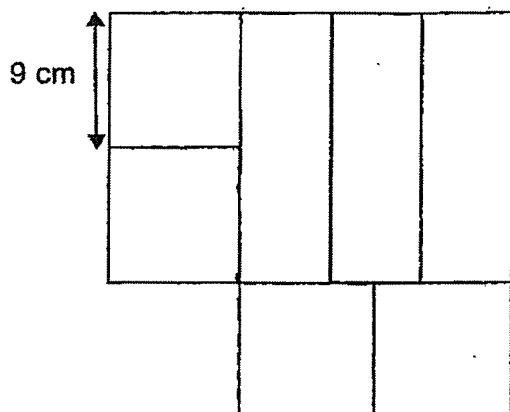

Ans: \_\_\_\_\_ cm<sup>2</sup>

35. The perimeter of a rectangular piece of land is 86 m. Its breadth is 16 m. Find its length.

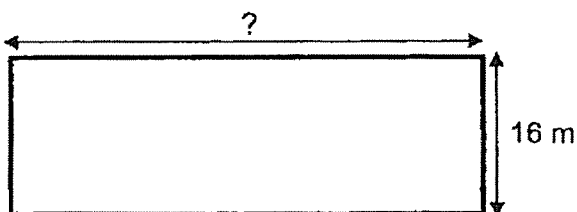

Ans: \_\_\_\_\_ m

Do not write  
in this space



36. The dotted line in the figure represents the line of symmetry. Draw the other half of the figure.

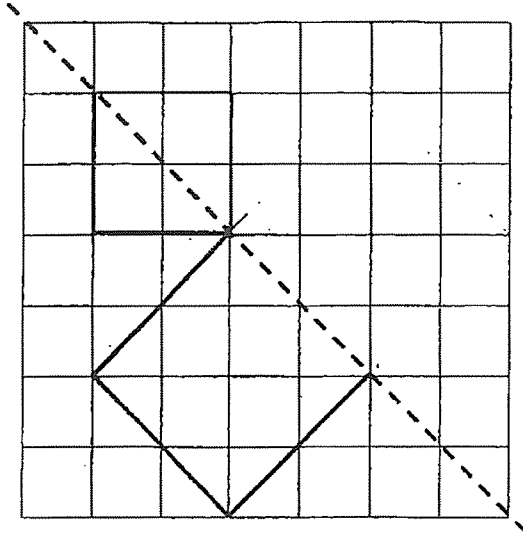

Do not write  
in this space



37. The figure below is made up of 5 identical squares. The perimeter of the figure is 80 cm. Find the length of one square.



Ans: \_\_\_\_\_ cm



38. Line AB is drawn in the grid below.  
Complete and label the square ABCD by drawing 3 more lines.

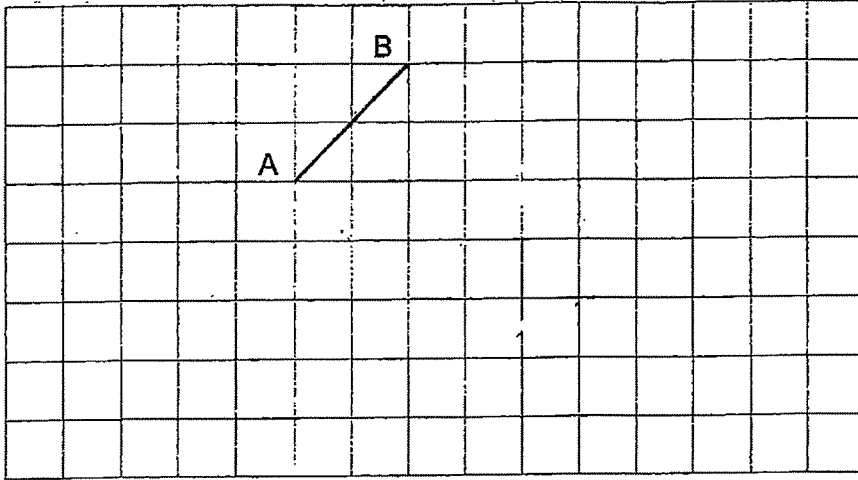

Do not write  
in this space



Study the line graph below carefully.

The line graph shows the number of movie tickets sold by a cinema from January to May.

Use the graph below to answer questions 39 and 40.

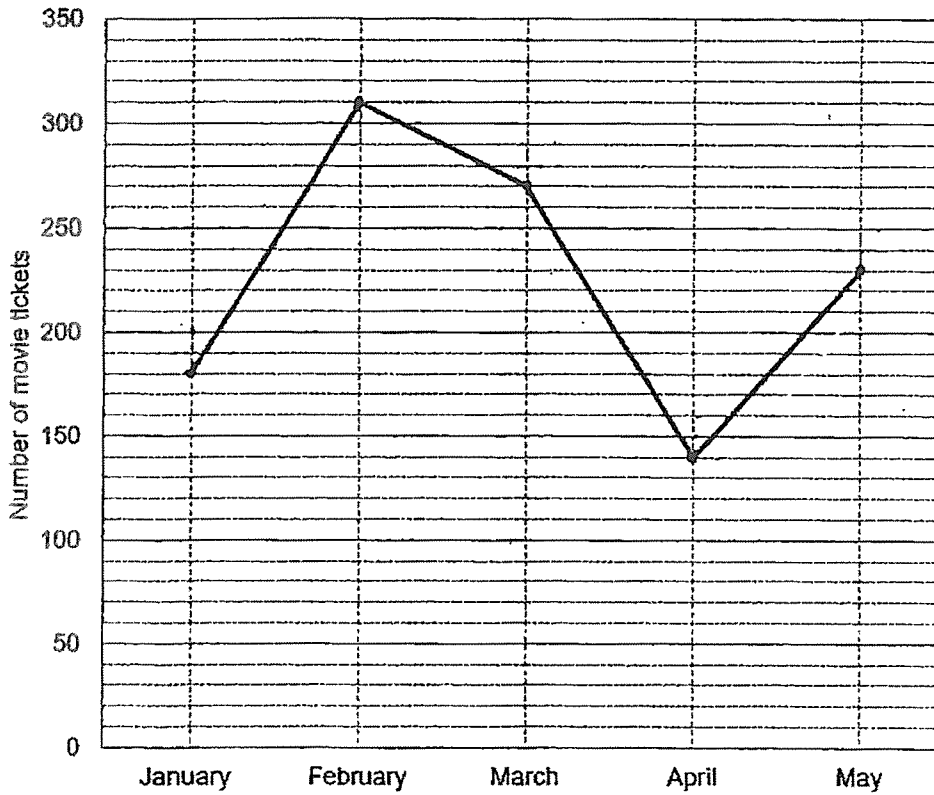

Do not write in this space

39. During which 1-month interval was the increase in the sale of movie tickets the greatest?

Ans: \_\_\_\_\_ to \_\_\_\_\_

40. What was the difference between the greatest and the least number of movie tickets sold?

Ans: \_\_\_\_\_

For questions 41 to 45, show your working clearly and write your answers in the spaces provided. The number of marks available is shown in brackets [ ] at the end of each question or part-question. (20 marks)

Do not write  
in this space

41. Ken has 600 stamps.

He gave  $\frac{3}{5}$  of the stamps to Tom,  $\frac{1}{10}$  of the stamps to John and kept the rest for himself.

(a) What fraction of the stamps did Ken keep for himself?

Ans: (a) \_\_\_\_\_ [2]

(b) How many more stamps did Ken give to Tom than to John?

Ans: (b) \_\_\_\_\_ [2]

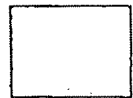

42. Magdalene and Angelina had 568 marbles altogether.  
Magdalene and Jeremy had 795 marbles altogether.  
Angelina had half the number of marbles as Jeremy.  
How many marbles did they have altogether?

Do not write  
in this spac

Ans: \_\_\_\_\_ [4]

43. Hakim, Gomez and Vignesh saved \$1895 in a particular month.  
Hakim saved six times as much money as Gomez.  
Gomez saved \$95 less than Vignesh.  
How much money did Hakim save?

Do not write  
in this space

Ans: \_\_\_\_\_ [4]

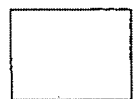

44. 4 files cost as much as 3 notebooks.

Martha paid \$84.60 for 2 files and 3 notebooks.

(a) How much does 1 file cost?

Ans: (a) \_\_\_\_\_ [2]

(b) How much do 3 notebooks cost?

Ans: (b) \_\_\_\_\_ [2]

Do not write  
in this space

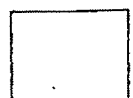

45. The figure below shows a square piece of paper that is made up of three identical rectangles. Two of the rectangles were cut out from the square piece of paper as shown in the diagram below. What is the area of the remaining piece of paper?

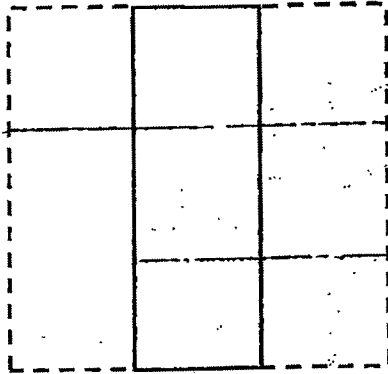

Do not write  
in this space

Ans: \_\_\_\_\_ [4]



---

END OF BOOKLET B

Have you checked your work carefully?

**SCHOOL :** ST HILDA'S PRIMARY SCHOOL  
**LEVEL :** PRIMARY 4  
**SUBJECT :** MATHEMATICS  
**TERM :** 2023 SA2

---

**BOOKLET A**

Q1	2	Q2	4	Q3	2	Q4	4	Q5	4
Q6	2	Q7	3	Q8	1	Q9	4	Q10	4
Q11	2	Q12	1	Q13	2	Q14	2	Q15	4
Q16	3	Q17	2	Q18	3	Q19	3	Q20	2

**BOOKLET B**

Q21	27070
Q22	7599
Q23	$\frac{7}{12}$
Q24	$1\frac{1}{6}$
Q25	$\frac{1}{3}$
Q26	1.34
Q27	0.018, 0.081, 1.08
Q28	53°
Q29	73°
Q30	3.38
Q31	$640 + 802 + 945 = 2387$ $3795 - 2387 = \mathbf{\$1408}$
Q32	$12 + 6 = 18$ $587 \times 18 = \mathbf{10566}$
Q33	$36 \div 5 = 7.2$ $36 + 7.2 = \mathbf{\$43.20}$
Q34	$162 + 486 = \mathbf{648 \text{ cm}^2}$
Q35	$86 \div 2 = 43$ $43 - 16 = \mathbf{27}$

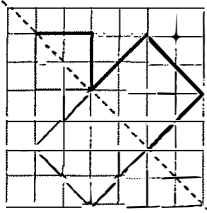
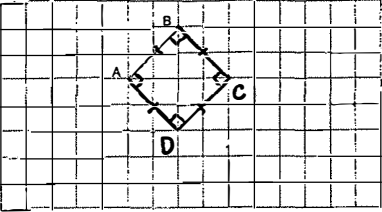
Q36	
Q37	$80 \div 10 = 8 \text{ cm}$
Q38	
Q39	January to February
Q40	$310 - 140 = 170$
Q41a	$\frac{3}{5} + \frac{1}{10} = \frac{6}{10} + \frac{1}{10} = \frac{7}{10}$ $\frac{10}{10} - \frac{7}{10} = \frac{3}{10}$
Q41b	$\frac{3}{5} - \frac{1}{10} = \frac{6}{10} - \frac{1}{10} = \frac{5}{10}$ $600 \div 10 = 60$ $60 \times 5 = 300$
Q42	$795 - 568 = 227$ $568 - 227 = 341$ $795 - 341 = 454$ $227 + 341 + 454 = 1022$
Q43	$1895 - 95 = 1800$ $1800 \div 5 = 225$ $225 \times 6 = \$1350$
Q44a	$84.60 \times 2 = 169.20$ $169.20 \div 3 = 56.40$ $56.40 \div 4 = \$14.10$
Q44b	$169.20 \div 3 = \$56.40$
Q45	$48 \div 12 = 4$ $4 \times 3 = 12$ $\text{Area of remaining paper} = 12 \times 4 = 48 \text{ cm}^2$