



NANYANG PRIMARY SCHOOL

**END-OF-YEAR EXAMINATION
2023**

PRIMARY 4

**MATHEMATICS
(BOOKLET A)**

Total Duration for Booklets A and B: 1 hour 45 minutes

Additional materials: Optical Answer Sheet (OAS)

INSTRUCTIONS TO PUPILS

1. Do not turn over this page until you are told to do so.
2. Follow all instructions carefully.
3. Answer all questions.
4. Shade your answers in the Optical Answer Sheet (OAS) provided.

Name: _____ ()

Class: Primary 4 ()

Questions 1 to 15 carry 2 marks each. For each question, four options are given. One of them is the correct answer. Make your choice (1, 2, 3 or 4) and shade your answer on the Optical Answer Sheet. (30 marks)

1. In which of the following numbers does the digit 5 stand for 50?

- (1) 5790
- (2) 7905
- (3) 7590
- (4) 9750

2. Which of the following numbers when rounded to the nearest ten becomes 81 500?

- (1) 81 444
- (2) 81 496
- (3) 81 506
- (4) 81 554

3. Which of the following is a multiple of 9?

- (1) 36
- (2) 28
- (3) 3
- (4) 19

4. What fraction of the shapes in the box are  ?

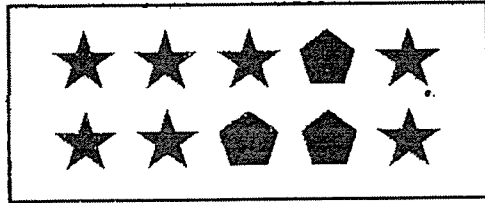

- (1) $\frac{3}{7}$
- (2) $\frac{3}{10}$
- (3) $\frac{7}{10}$
- (4) $\frac{7}{3}$
5. Which of the following decimals is the smallest?

- (1) 4.06
- (2) 4.16
- (3) 4.036
- (4) 4.306

6. In the figure, which angle is a right angle?

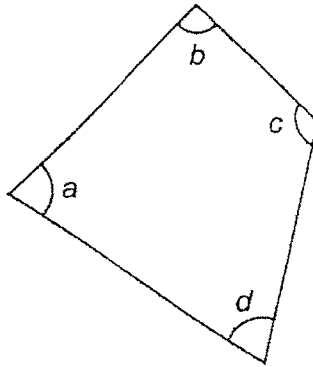

- (1) $\angle a$
- (2) $\angle b$
- (3) $\angle c$
- (4) $\angle d$
7. Nelly sells 384 muffins every month. How many muffins will she sell in a year?
- (1) 4608
- (2) 3408
- (3) 1608
- (4) 1152
8. When a number is divided by 9, it has a remainder of 2. Which of the following could be the number?
- (1) 5786
- (2) 5787
- (3) 5788
- (4) 5789

9. Joel runs 300 m every morning. His slowest record is 1 min 35 s. His fastest record is 55 s. What is the difference between his fastest record and his slowest record?

- (1) 190 s
- (2) 150 s
- (3) 80 s
- (4) 40 s

10. The table below shows the prices of tickets for a carnival.

Type	Mon to Fri	Sat and Sun
Adult	\$24.90	\$29.95
Child (below 12 years)	\$12.65	\$15.95

On Sunday, Mr Lee and Mrs Lee brought their 10-year-old son to the carnival. They bought three tickets in all. How much did they pay for their tickets altogether?

- (1) \$75.85
- (2) \$62.45
- (3) \$45.90
- (4) \$37.55

11. The table below shows how Tiana spent her money.

	Magazine	Storybook	Bag	Pencil Case
Amount spent (\$)	6	15	20	15

Which of the following bār graphs best represents Tiana's spending shown in the table above?

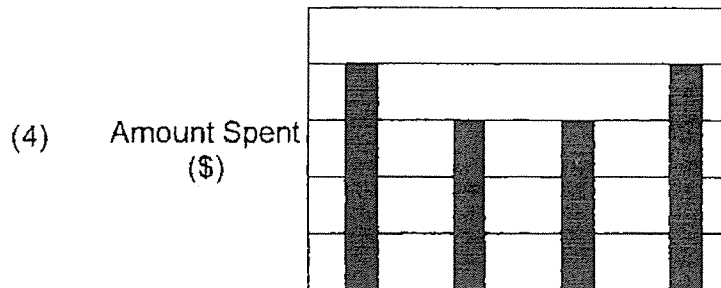
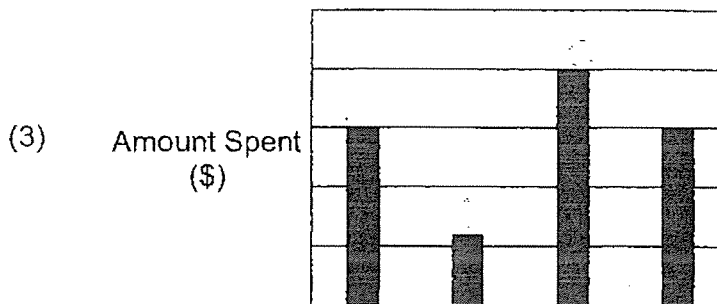
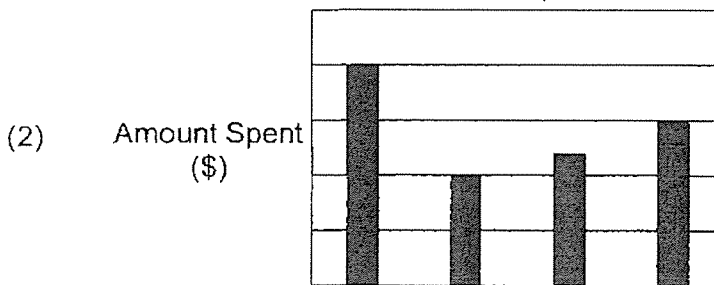
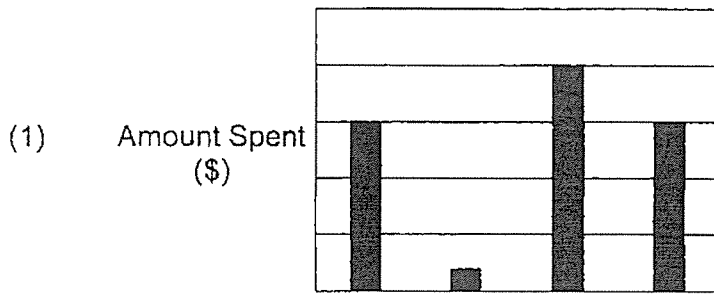

12. The areas of Square P and Rectangle Q are the same. The length of Square P is 8 cm. The breadth of Rectangle Q is 4 cm. What is the length of Rectangle Q?

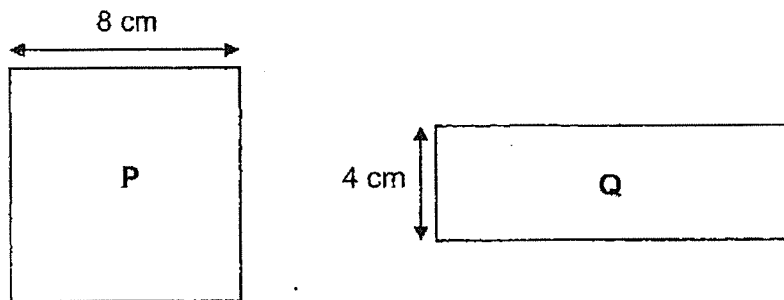

- (1) 56 cm
 (2) 32 cm
 (3) 28 cm
 (4) 16 cm
13. Study the number pattern below.

100		120		140		160		180	
250	300	270	360	290	420	?	?	330	540

What is the sum of the two missing numbers?

- (1) 310
 (2) 480
 (3) 670
 (4) 790

14. Jeraldine baked a total of 749 cupcakes to sell at a carnival. Figure 1 shows the number of cupcakes that were sold. Figure 2 shows the number of cupcakes that were left unsold at the end of the carnival. The number of Red Velvet cupcakes that were left unsold is not shown in Figure 2.

Figure 1

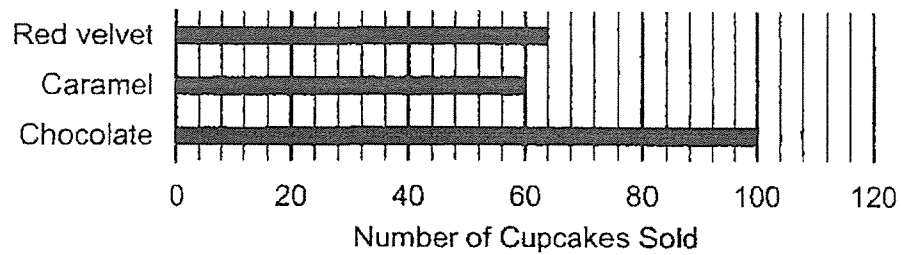
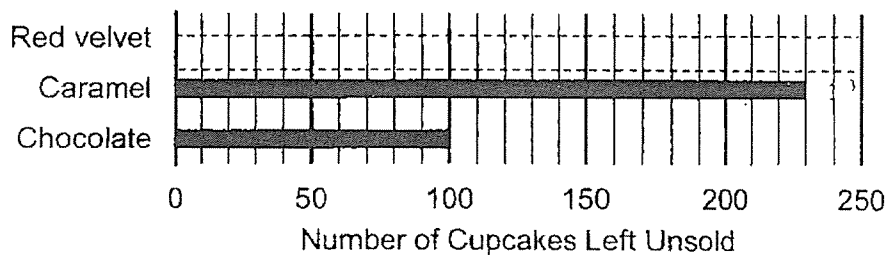

Figure 2



Which table below shows the correct number of cupcakes which were left unsold?

- (1)
- | | Number of Cupcakes Left Unsold |
|------------|--------------------------------|
| Red velvet | 62 |
| Caramel | 60 |
| Chocolate | 100 |
- (2)
- | | Number of Cupcakes Left Unsold |
|------------|--------------------------------|
| Red velvet | 64 |
| Caramel | 60 |
| Chocolate | 100 |
- (3)
- | | Number of Cupcakes Left Unsold |
|------------|--------------------------------|
| Red velvet | 195 |
| Caramel | 230 |
| Chocolate | 100 |
- (4)
- | | Number of Cupcakes Left Unsold |
|------------|--------------------------------|
| Red velvet | 215 |
| Caramel | 230 |
| Chocolate | 100 |

15. The graph below shows the number of seconds taken by four boys to complete a race. The number of seconds taken is not shown on the scale.

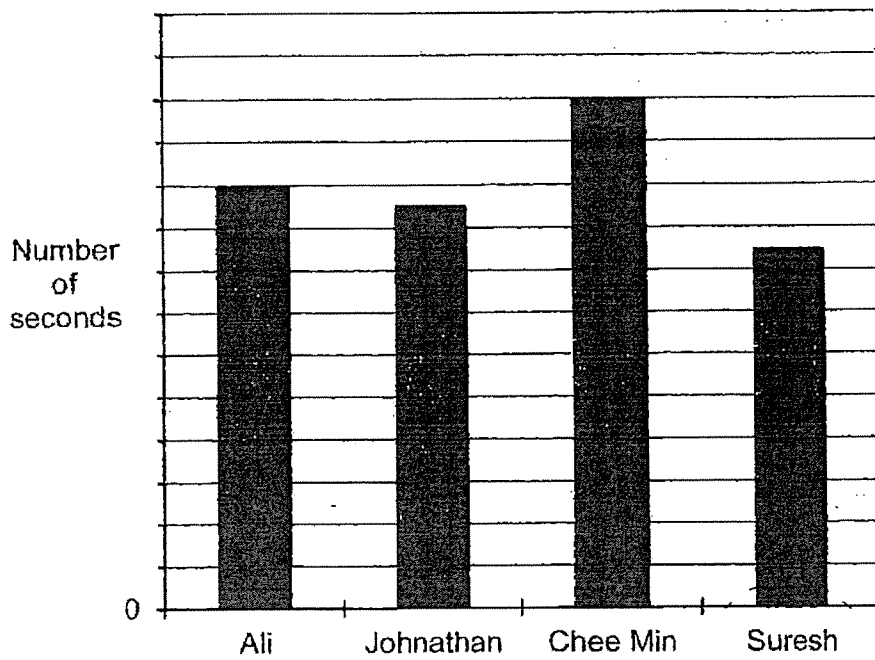

Ali took 5 seconds less than Chee Min to complete the race.

Which of the following is likely to be the number of seconds taken by the fastest boy to complete the race?

- (1) 8.45
- (2) 21.15
- (3) 30.00
- (4) 42.52



NANYANG PRIMARY SCHOOL

**END-OF-YEAR EXAMINATION
2023**

PRIMARY 4

**MATHEMATICS
(BOOKLET B)**

Total Duration for Booklets A and B: 1 hour 45 minutes

INSTRUCTIONS TO PUPILS

1. Do not turn over this page until you are told to do so.
2. Follow all instructions carefully.
3. Answer all questions.
4. Write your answers in this booklet.

Name: _____ ()

Class: Primary 4 ()

Parent's Signature: _____

Booklet A	/ 30
Booklet B	/ 70
Total	/ 100

Please sign and return the examination paper the next day. Any queries should be raised at the same time when returning paper.

Questions 16 to 35 carry 2 marks each. Show your working clearly and write your answers in the spaces provided. For questions which require units, give your answers in the units stated. (40 marks)

16. What number is 100 more than 8887?

Ans: _____

17. Write $\frac{23}{7}$ as a mixed number.

Ans: _____

18. Arrange the following fractions from the greatest to the smallest.

$$\frac{2}{3}, \frac{3}{4}, \frac{5}{12}$$

Ans: _____ , _____ , _____
(greatest) (smallest)

19. Find the value of $\frac{7}{8} - \frac{1}{2}$.

Ans: _____

20. Express 0.6 as a fraction.

Ans: _____

21. Round 32.55 to the nearest whole number.

Ans: _____

22. Write the decimal represented by A.

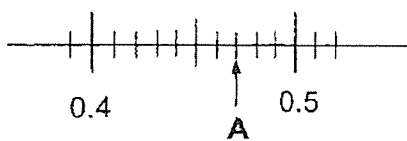

Ans: _____

23. Find the value of 6.53×8 .

Ans: _____

24. Measure and write down the size of $\angle x$.

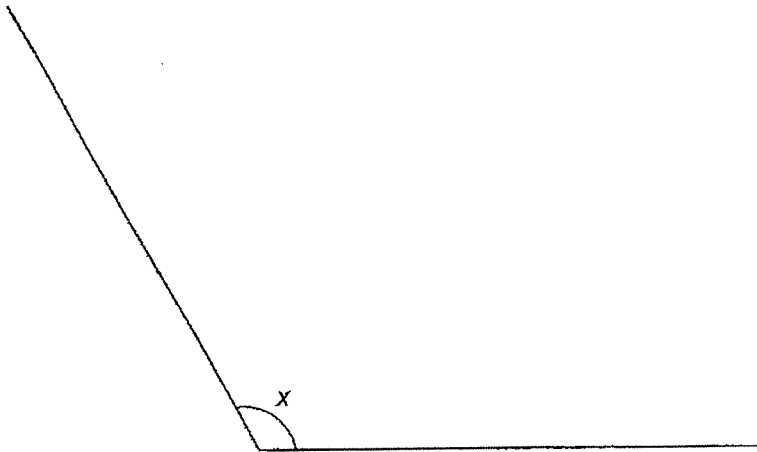

Ans: _____°

25. The area of a square is 36 cm^2 . It is being cut into 2 identical smaller rectangles. Find the breadth of the smaller rectangle.

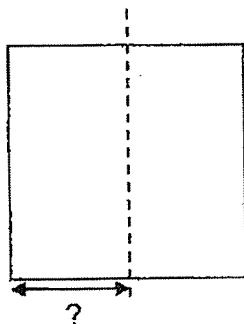

Ans: _____ cm

28. David was standing at point X in the figure below. He was facing the National Stadium at first. He made a $\frac{3}{4}$ turn in a clockwise direction. He then turned through an angle of 135° in an anti-clockwise direction. What place and direction was he facing in the end?

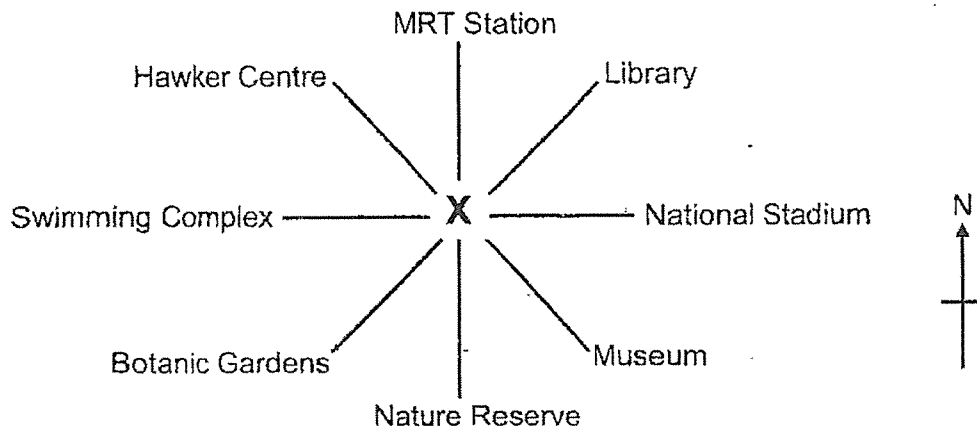

Ans: Place: _____

Direction: _____

29. The figure below is not drawn to scale. PQRS is a rectangle. Find $\angle MPS$.

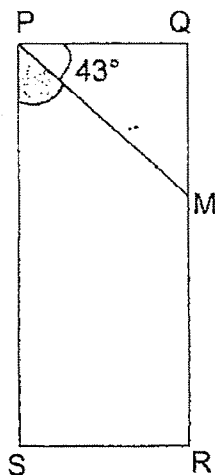

Ans: _____^o

30. Draw and label square MNOP on the square grid. One side of the square has been drawn for you.

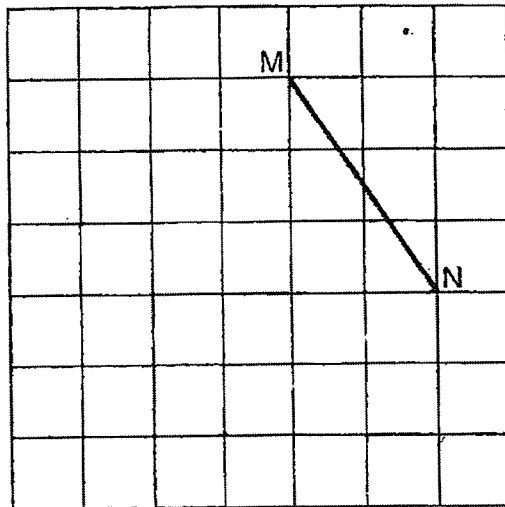

31. Complete the figure on the square grid below so that it is symmetric about the line of symmetry JK.

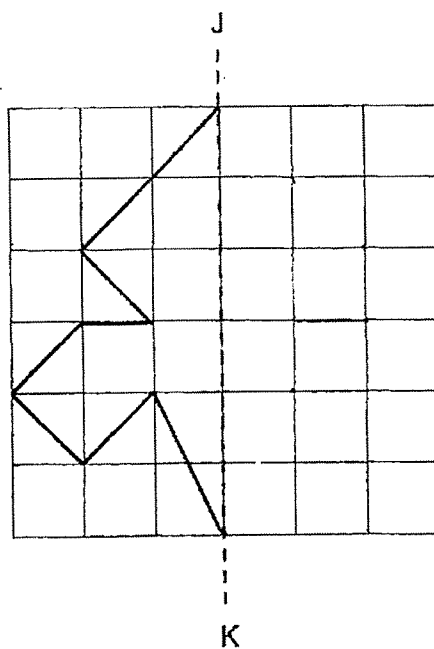

32. The line graph below shows the length of a spring when various masses are hung on it.

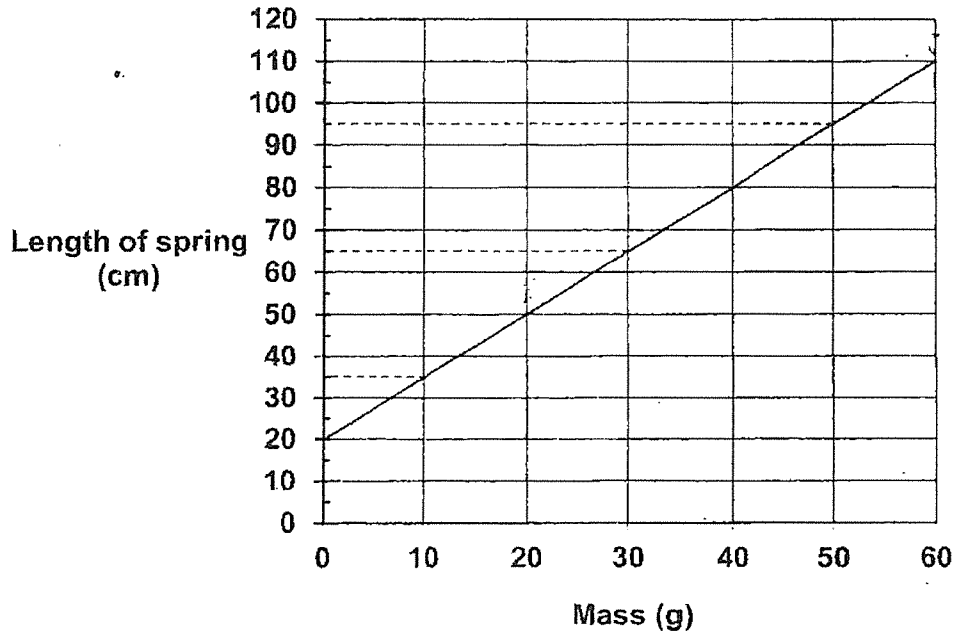

What is the increase in the length of the spring when the mass hung on it is increased from 20g to 60g?

Ans: _____ cm

33. The difference between two fractions is $\frac{2}{9}$. The smaller fraction is $\frac{1}{6}$.

What is the sum of the two fractions? Express your answer in its simplest form.

Ans: _____

34. At first, Peter had twice as much savings as Michelle. After Michelle received \$5499, she had twice as much savings as Peter. What is their total savings now?

Ans: \$ _____

35. The figure below is made up of a rectangle and 2 squares, A and B. Find the perimeter of the figure.

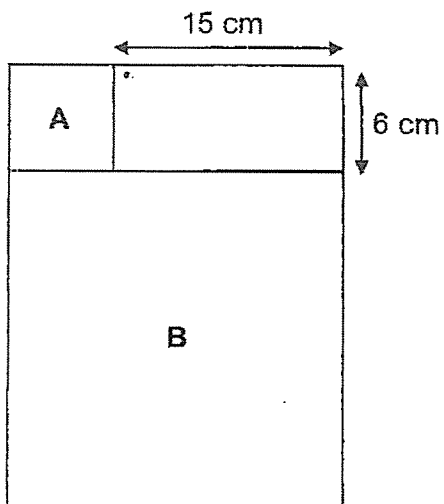

Ans: _____ cm

For questions 36 to 43, show your working clearly and write your answers in the spaces provided. The number of marks available is shown in brackets [] at the end of each question or part-question. (30 marks)

36. A tank had 25.68 l of water. 9 l of water was poured out of the tank. The remaining amount of water was then poured equally into 6 empty bottles. How much water was poured into each bottle?

Ans: _____ [3]

37. A movie at a cinema started at 11.49 a.m. Jasmine arrived at the cinema late and started watching the movie 18 minutes after the movie had started. She watched the movie for 2 h 24 min. What time did the movie end? (Express your answer in 24-hour clock)

Ans: _____ [3]

38. Eight squares of length 2 cm were cut out from a rectangular piece of paper as shown below. Find the area of the remaining paper.

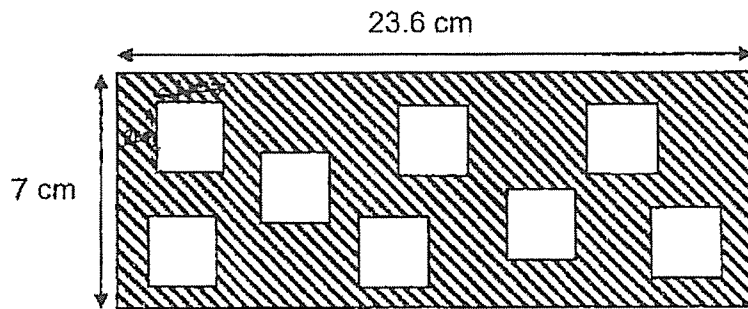

Ans: _____ [4]

39. The line graph below shows the number of tourists who visited the Night Safari from January to July.

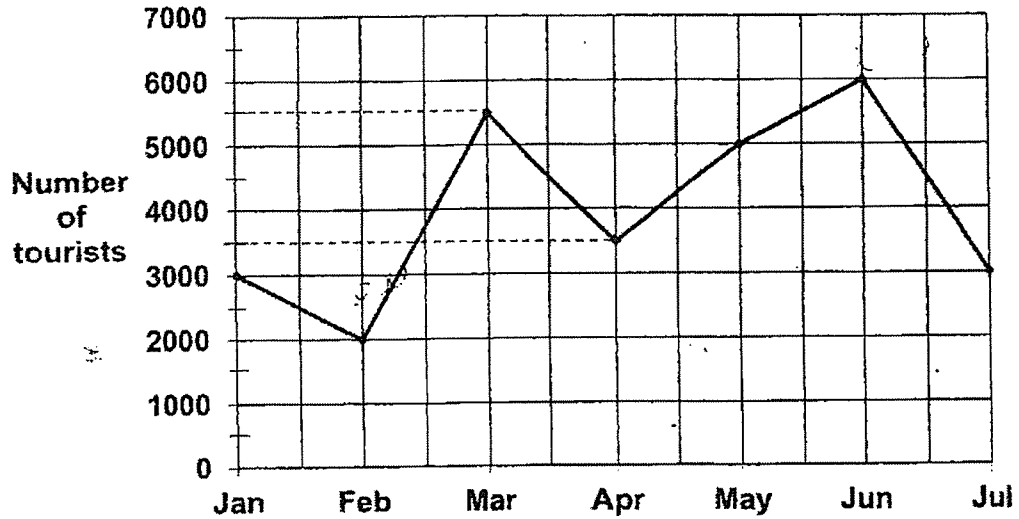

- (a) What was the difference between the greatest and the least number of tourists who visited the Night Safari?

Ans: (a) _____ [2]

- (b) What was the total number of tourists who visited the Night Safari for the first half of the year?

Ans: (b) - _____ [2]

40. Mr Lee sold a total of 25.5 kg of corn flour and plain flour. He sold 5 more packets of corn flour than plain flour. Each packet of corn flour had a mass of 2.7 kg and each packet of plain flour had a mass of 1.3 kg.

(a) What was the mass of 5 packets of corn flour?

Ans: (a) _____ [2]

(b) How many packets of plain flour did he sell?

Ans: (b) _____ [2]

41. A sum of \$7082 was shared among Kumar, Wei Ming and Hakim. Wei Ming received twice as much money as Kumar. Hakim received 3 times as much money as Wei Ming.

(a) How much money did Kumar receive?

Ans: (a) _____ [2]

(b) How much money did Hakim receive?

Ans: (b) _____ [2]

42. After a florist sold $\frac{2}{3}$ of her roses and $\frac{5}{9}$ of her tulips, she had the same number of roses and tulips left. The number of tulips she sold was 85.

(a) How many tulips did she have left?

Ans: (a) _____ [2]

(b) How many roses did she have at first?

Ans: (b) _____ [2]

43. There was a total of 60 bicycles and tricycles in a shop.
A bicycle has 2 wheels and a tricycle has 3 wheels.
There were 156 wheels altogether.

(a) How many bicycles were there?

Ans: (a) _____ [2]

(b) How many more tricycles than bicycles were there in the shop?

Ans: (b) _____ [2]

End of Paper

SCHOOL : NANYANG PRIMARY SCHOOL
LEVEL : PRIMARY 4
SUBJECT : MATHEMATICS
TERM : 2023 SA2 END OF YEAR EXAM

Booklet A

Q1	Q2	Q3	Q4	Q5	Q6	Q7	Q8	Q9	Q10
4	2	1	2	3	2	1	4	4	1
Q11	Q12	Q13	Q14	Q15					
3	4	4	3	2					

Booklet B

Q16	8987
Q17	$3\frac{2}{7}$
Q18	$\frac{3}{4}, \frac{2}{3}, \frac{5}{12}$
Q19	$\frac{7}{8} - \frac{1}{2} = \frac{7}{8} - \frac{4}{8} = \frac{3}{8}$
Q20	$\frac{6}{10}$
Q21	33
Q22	0.47
Q23	52.24
Q24	119°
Q25	3cm
Q26	57°
Q27	8am to 5am: duration of 21 hours $21 \div 3 = 7$
Q28	Place: Botanic Gardens, Direction: South-west
Q29	$90^\circ - 43^\circ = 47^\circ$
Q30	