

HENRY PARK PRIMARY SCHOOL  
2023 END OF YEAR EXAMINATION  
MATHEMATICS  
PRIMARY 4

Name: \_\_\_\_\_ (     )

Parent's Signature

Class: Primary 4 \_\_\_\_\_

\_\_\_\_\_

Duration of Paper: 1 h 45 min

Marks:

Section A (MCQ)	20
Section B (Open-Ended)	50
Section C (Problem Sums)	30
<b>Total</b>	<b>100</b>

**SECTION A: Multiple-Choice Questions (20 marks)**

Questions 1 to 10 carry 2 mark each.

For each question, four options are given. One of them is the correct answer.

Make your choice (1, 2, 3 or 4) and shade your answer in the Optical Answer Sheet.

---

1.  $60\ 000 + 4\ 000 + 800 + 7 = \underline{\hspace{2cm}}$

(1) 64 870

(2) 64 807

(3) 64 087

(4) 60 487

( )

2. Complete the following number pattern.

7, 11, 15, \_\_\_\_\_, \_\_\_\_\_, 27

(1) 16, 17

(2) 16, 26

(3) 19, 20

(4) 19, 23

( )

3. How many sixths are there in 2 wholes?

(1)  $\frac{1}{3}$

(2) 6

(3) 3

(4) 12

( )

4. Which of the following decimals is the smallest?

(1) 4.07

(2) 4.18

(3) 4.032

(4) 4.85

( )

5. In which of the following numbers does the digit 7 stand for 7 tenths?

(1) 413.75

(2) 371.54

(3) 237.68

(4) 123.17

( )

6. One of the lines in the figure shown below is parallel to JK.  
Which line is parallel to JK?

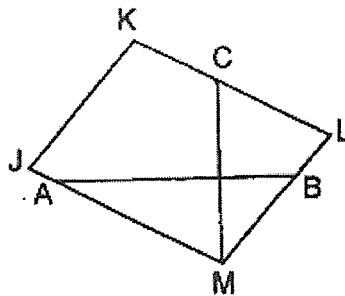

(1) AB

(2) CM

(3) KL

(4) LM

( )

7. The graph below shows the favourite sport of some students.

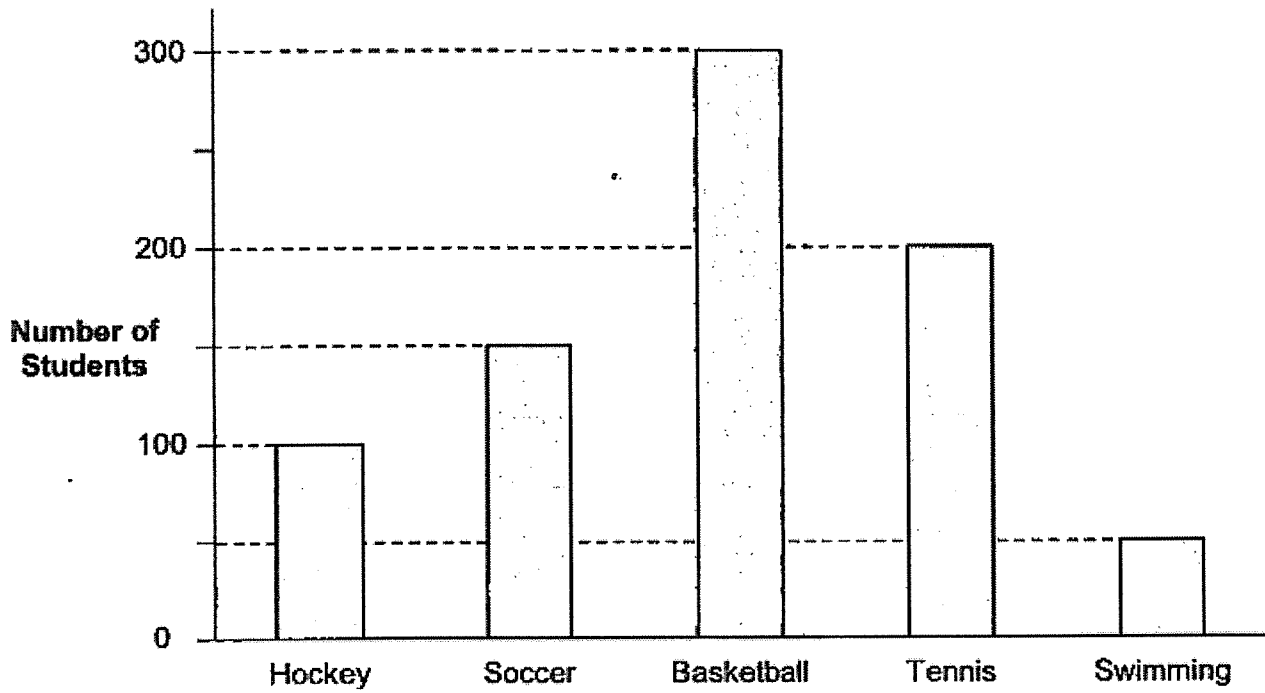

Which sport is twice as popular as hockey?

- (1) Tennis
- (2) Soccer
- (3) Basketball
- (4) Swimming

( )

8. The figure below is formed using 2 squares. Find the perimeter of the figure.

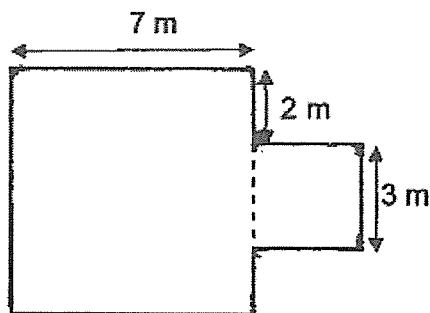

- (1) 12 m  
(2) 28 m  
(3) 34 m  
(4) 49 m ( )
9. Madam Lim bought  $\frac{4}{5}$  kg of chicken meat. She bought  $\frac{3}{10}$  kg less than the amount of chicken meat bought by Mrs Tan. How many kilograms of chicken meat did Mrs Tan buy?

- (1)  $\frac{1}{10}$  kg  
(2)  $\frac{1}{2}$  kg  
(3)  $\frac{7}{15}$  kg  
(4)  $1\frac{1}{10}$  kg ( )

10. George was at a restaurant in a zoo.

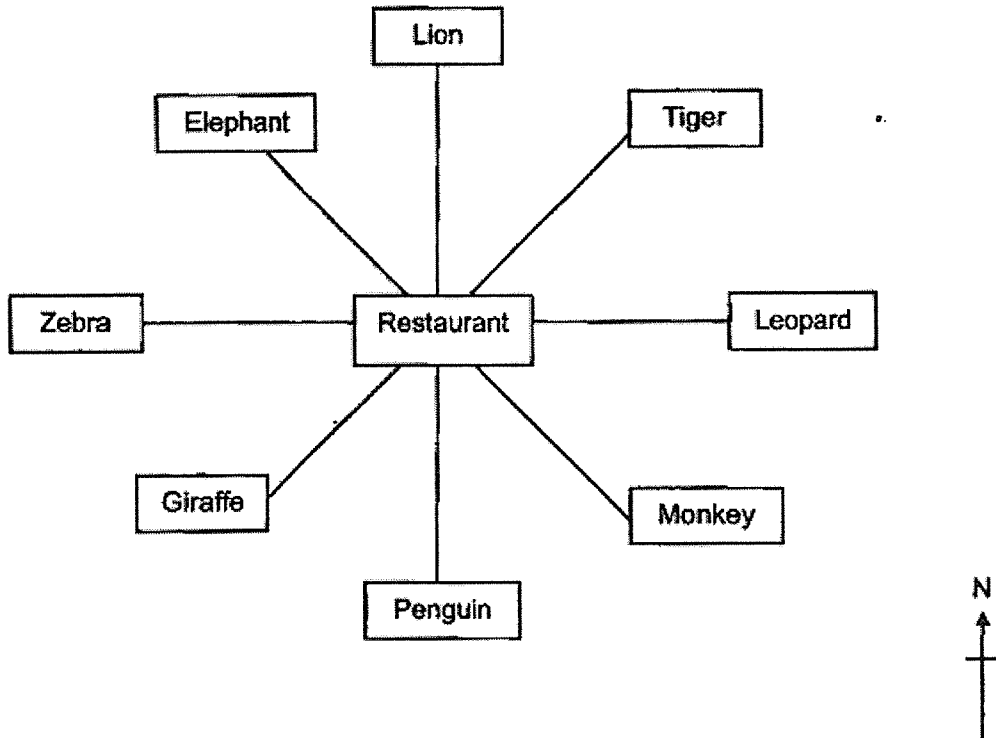

At the restaurant, George was facing south-west at first. He then made a  $\frac{3}{4}$ -turn clockwise. Which animal would he be facing then?

- (1) Lion
- (2) Tiger
- (3) Monkey
- (4) Elephant

(     )

(Go on to SECTION B)



14. Which two of the following fractions are in the simplest form?

$$\frac{2}{3}, \frac{10}{12}, \frac{3}{7}, \frac{6}{8}$$

Ans: \_\_\_\_\_ and \_\_\_\_\_

Do not write  
in this space

15.  $\frac{1}{3} + \frac{1}{12} =$  \_\_\_\_\_

Ans: \_\_\_\_\_

16. Find the value of  $1 - \frac{3}{5} - \frac{1}{10}$ .

Ans: \_\_\_\_\_

17. Write 5 thousandths as a decimal.

Do not write  
in this space

Ans: \_\_\_\_\_

18. Round 117.65 to the nearest whole number.

Ans: \_\_\_\_\_

19. In the figure below, name the smallest angle.

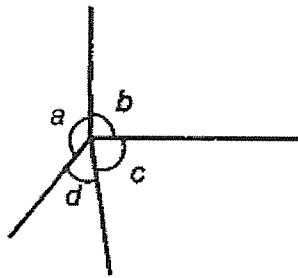

Ans:  $\angle$  \_\_\_\_\_

20. A square has an area of  $64 \text{ cm}^2$ . Find the length of the square.

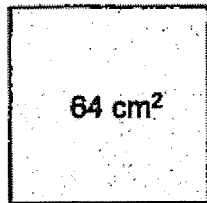

Ans: \_\_\_\_\_ cm

Do not write  
in this space

21. The table below shows the number of pets that students have at home.

Number of pet(s) per student	0	1	2	3	4
Number of student(s)	12	15	3	9	1

How many students have more than 2 pets?

Ans: \_\_\_\_\_

22. Xiao Hui had more than 10 and fewer than 40 candies. When she packed the candies in bags of 7, she was left with 2 candies. When she packed them in bags of 3, she had no candies left. How many candies did Xiao Hui have?

Do not write  
in this space

Ans: \_\_\_\_\_

23. Jeremy thought of a decimal number with 3 decimal places. When he rounded the number to the nearest hundredth, the value was 10.05. Find the greatest possible value of the decimal number Jeremy thought of.

Ans: \_\_\_\_\_

24. The difference between the two numbers is 6.18. Given the larger number is 8.03, find the value of the smaller number.

Ans: \_\_\_\_\_

25(a) Shade 2 more squares to form a symmetric figure with AB as the line of symmetry.

Do not write in this space

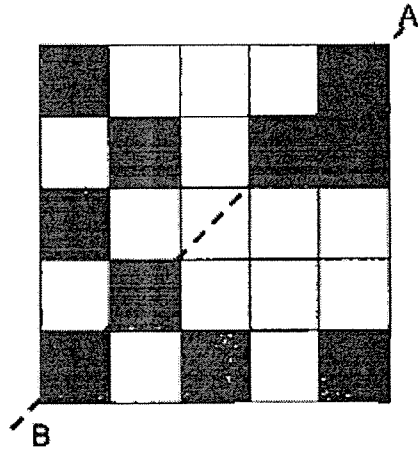

25(b) Complete the symmetric figure below using a ruler and pencil.

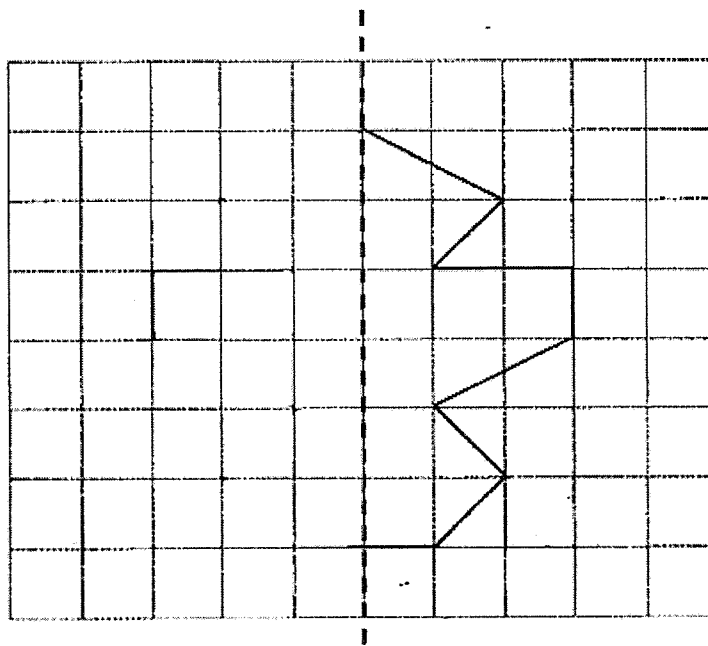

26. Which of the following figures has /have at least one line of symmetry?

Do not write  
in this space

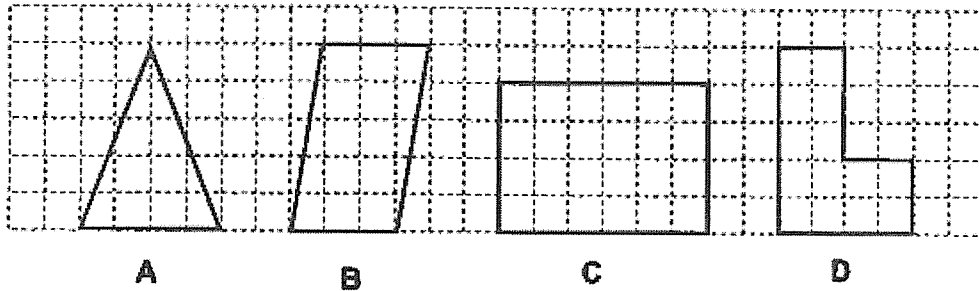

Ans: Figure(s) \_\_\_\_\_

27. A piece of wire is used to form a rectangle with an area of  $120 \text{ cm}^2$ . The breadth of the rectangle is  $8 \text{ cm}$ . Find the perimeter of the rectangle.

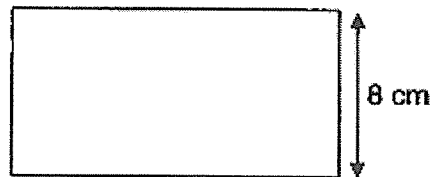

Ans: \_\_\_\_\_ cm

28. Yan Ling started reading at 4.20 p.m. She read for 1 h 35 min. What time did she stop reading?

Ans: \_\_\_\_\_ p.m.

29. The line graph below shows the amount of flour bought by a bakery for 5 days.

Do not write in this space

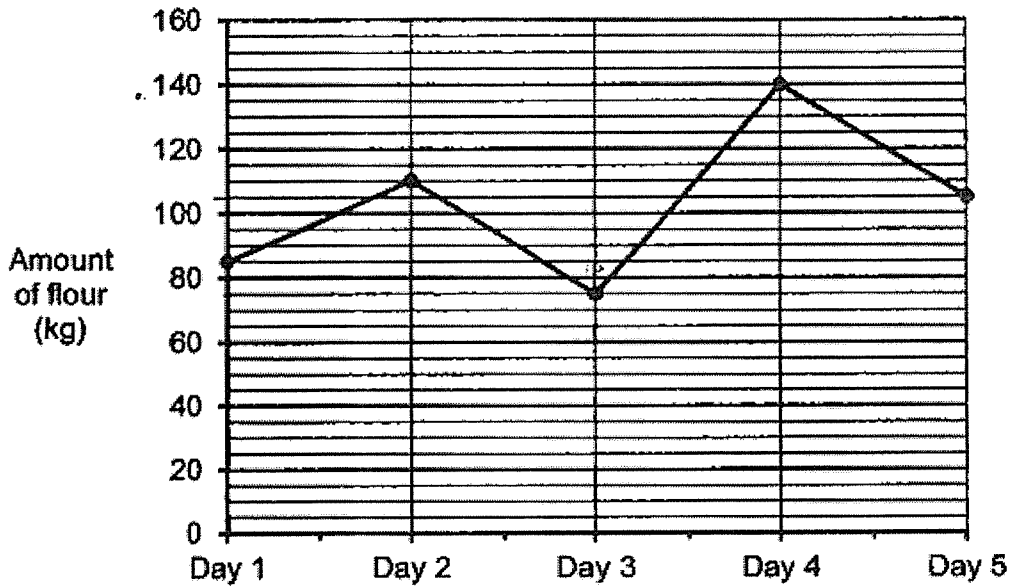

All the flour bought by the bakery was sold in packets of 5 kg. Each packet of flour cost \$20.  
How much more money did the bakery pay for the flour on Day 5 than Day 3?

Ans: \$ \_\_\_\_\_

30. The table below shows the entrance fees to the Singapore Zoo.

Do not write  
in this space

	Monday to Friday	Saturday and Sunday
Adult	\$48	\$58
Child (3 to 12 years old)	\$33	\$43
Senior Citizen (60 years old and above)	\$20	\$25

On Sunday, Mr and Mrs Fong, their ten-year-old child and sixty-five-year-old mother visited the Singapore Zoo. How much did the family pay for the entrance fees altogether?

Ans: \$ \_\_\_\_\_

31. Shop A has 50 apples more than Shop B. Shop A has twice as many apples as Shop C. Given that shops A, B and C have 250 apples altogether, how many apples does Shop C have?

Ans: \_\_\_\_\_

32. Ramli spent  $\frac{1}{3}$  of his monthly salary on a television. He spent  $\frac{2}{9}$  of his salary on food and saved the rest. Given that Ramli saved \$2392, how much did Ramli spend on food?

Ans: \$ \_\_\_\_\_

33. The total mass of 2 packets of sugar and 2 packets of flour was 6.54 kg. The mass of 1 packet of flour was twice as heavy as 1 packet of sugar. What was the mass of a packet of flour?

Ans: \_\_\_\_\_ kg

34. Patrick bought 4 cupcakes. He gave the cashier some money and received \$3.60 as change. Given that each cupcake cost \$2.85, how much did he give the cashier?

Do not write  
in this space

Ans: \$ \_\_\_\_\_

35. The figure below shows a rectangle where  $\angle a$  is twice the size of  $\angle b$ . Find  $\angle a$ .

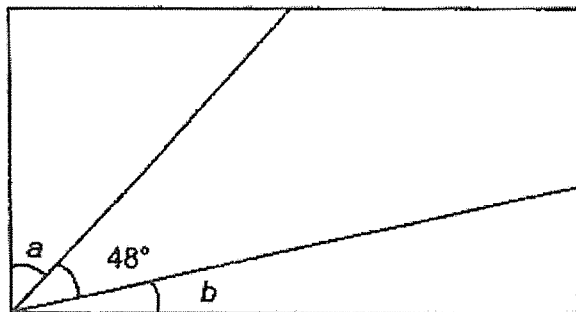

Ans: \_\_\_\_\_ °

(Go on to SECTION C)



NAME: \_\_\_\_\_ CLASS: Primary 4 \_\_\_\_\_

Do not write  
in this space

**SECTION C: Problem Sums (30 marks)**

For questions 36 to 43, show your working clearly and write your answers in the spaces provided. The number of marks available is shown in the brackets [ ] at the end of each question or part-question.

35. A total of 2590 adults and children attended a family event on one weekend. 1770 adults attended the event. The number of adults at the event was three times as many as the number of boys.

(a) How many children were there at the event?

Ans: (a) \_\_\_\_\_ [2]

(b) How many girls were at the event?

Ans: (b) \_\_\_\_\_ [2]

37. Line XY is drawn for you in the square grid below.

Do not write  
in this space

(a) Line XY is perpendicular to Line YK. Line XY is the same length as line YK. Draw and label line YK in the square grid below. [1]

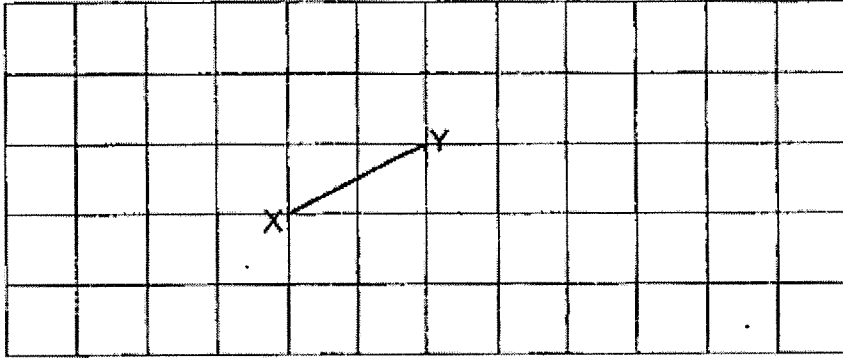

(b) Draw and label a square ABCD such that it has a side that is twice the length of line XY in (a). [2]

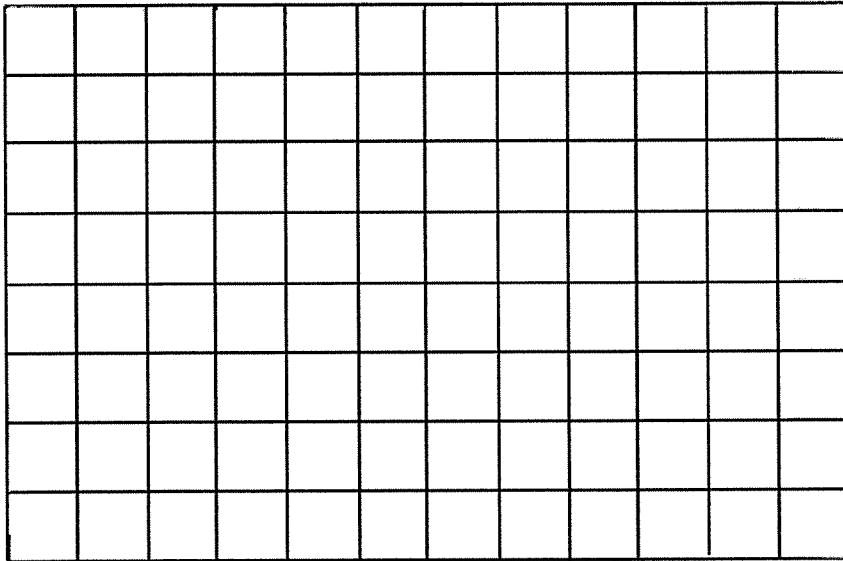

38. At first, Mary had \$166 and Larry had \$304. Each of them bought 5 similar plates. Each of the plates they bought was of the same price. After buying the plates, Larry had 4 times as much money as Mary left.

(a) How much money did Mary have left after buying the 5 plates?

Ans: (a) \_\_\_\_\_ [2]

(b) What was the price of one plate?

Ans: (b) \_\_\_\_\_ [2]



39. The total mass of 3 children is 115.9 kg. John weighs twice as heavy as Amelia. Max is 8.4 kg heavier than John.

(a) What is Amelia's mass?

Ans: (a) \_\_\_\_\_ [2]

(b) What is the difference between Amelia's and Max's mass?

Ans: (b) \_\_\_\_\_ [2]



40. Casey used 2 identical rectangular tiles to form the figure below.

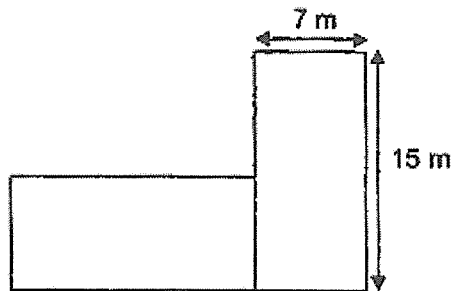

(a) Find the area of the figure.

Ans: (a) \_\_\_\_\_ [2]

(b) Find the perimeter of the figure.

Ans: (b) \_\_\_\_\_ [2]



41. Mr Lee started working on his project at 8.45 a.m. He took a 40-minute lunch break. Then, he continued working on the project till he finished it at 5.30 p.m.

(a) How long did Mr Lee spend working on his project?

Ans: (a) \_\_\_\_\_ [2]

(b) Mr Lee reached the gym at 5.45 p.m. He exercised for 1 hour 40 minutes before driving home. He reached home at 7.50 p.m. How long did he take to drive home?

Ans: (b) \_\_\_\_\_ [2]



42. Andrew has 1250 stickers and Ben has 490 stickers more than Andrew. Ben gave some of his stickers to Andrew. In the end, Ben had 626 stickers less than Andrew. How many stickers did Ben give to Andrew?

Do not write  
in this space

Ans: \_\_\_\_\_ [3]

43. In a box,  $\frac{1}{8}$  of the marbles were blue.  $\frac{7}{12}$  of the marbles were red. There was an equal number of blue and green marbles in the box. The rest of the marbles were pink. There was a total of 581 green and pink marbles in the box. How many red marbles were there in the box?

Do not write  
in this space

Ans: \_\_\_\_\_ [4]



Setters: Mr Darren Lau, Madam Catherine Ong, Ms Joyce Zheng

SCHOOL : HENRY PARK SCHOOL  
LEVEL : PRIMARY 4  
SUBJECT : MATH  
TERM : SA2 2023

---

Q1	Q2	Q3	Q4	Q5	Q6	Q7	Q8	Q9	Q10
2	4	4	3	1	4	1	3	4	3

Q11)	3267
Q12)	852
Q13)	3 and 4
Q14)	$\frac{2}{3}$ and $\frac{3}{7}$
Q15)	$\frac{5}{12}$
Q16)	$\frac{3}{10}$
Q17)	0.005
Q18)	118
Q19)	d
Q20)	8 cm
Q21)	10
Q22)	30
Q23)	10.054
Q24)	1.85

Q25)

a)

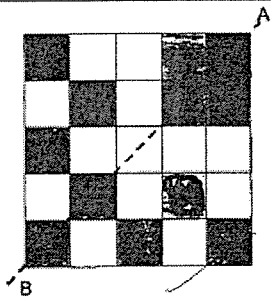

b)

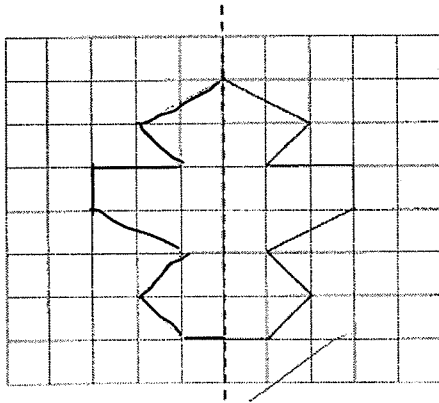

Q26) A and C

Q27) 46 cm

Q28) 5.55 p.m.

Q29) \$120

Q30)  $58 \times 2 = 116$   
 $116 + 43 = 159$   
 $159 + 25 = \$184$

Q31)  $250 + 50 = 300$   
 $300 \div 5 = 60$   
 $60 - 50 = 10$   
 $250 - 60 - 10 = 180$   
 $180 \div 3 = 60$

Q32) \$1196

Q33)  $6.54 \div 6 = 1.09$   
 $1.09 \times 2 = 2.18 \text{ kg}$

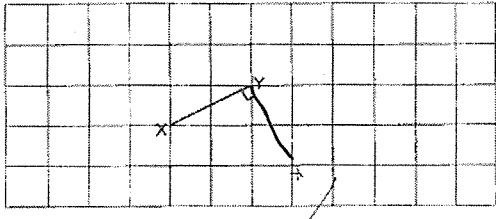
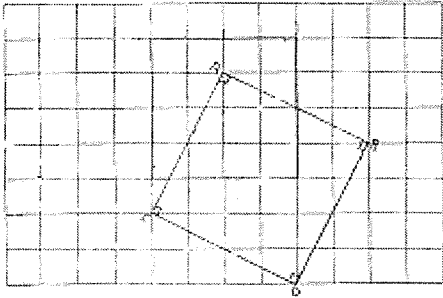
Q34)	$2.85 \times 4 = 11.40$ $11.40 + 3.60 = \$15$
Q35)	$90 - 48 = 42$ $42 \div 3 = 14$ $14 \times 2 = 28^\circ$
Q36)	a) $2590 - 1770 = 820$ b) $1770 \div 3 = 590$ $820 - 590 = 230$
Q37)	a) <div style="text-align: center;">  </div> b) <div style="text-align: center;">  </div>
Q38)	a) $304 - 166 = 138$ $138 \div 3 = \$46$ b) $166 - 46 = 120$ $120 \div 5 = \$24$
Q39)	a) $115.9 - 84 = 107.5$ $107.5 \div 5 = 21.5 \text{ kg}$ b) $21.5 + 21.5 = 43.0$ $43.0 + 8.4 = 51.4$ $51.4 - 21.5 = 29.9 \text{ kg}$
Q40)	a) $7 \times 15 = 105$ $105 + 105 = 210 \text{ 2}$ b) $15 \times 2 = 30$ $15 + 7 = 22$ $22 \times 2 = 44$ $44 + 30 = 74\text{m}$

Q41)	a)8h 5min b)25 min
Q42)	$1250 + 490 = 1740$ $1740 + 1250 = 2990$ $2990 - 626 = 2364$ $2364 \div 2 = 1182$ $1740 - 1182 = 558$
Q43)	1162